



...těsní hned

KATALOG 2019

Vrbovec 321, 671 24 Vrbovec, Česká republika

Email: info@aditeg.cz

Telefon / fax: +420 515 320 023 / +420 515 320 024

www.aditeg.cz

OBSAH

O NÁS

str. 3

VLASTNOSTI ELASTOMERŮ

str. 8

DESKY

str. 11

DESKY PRYŽOVÉ

- materiál SBR	str. 12
- materiál NBR	str. 14
- materiál EPDM	str. 16
- materiál CR	str. 17
- materiál FPM	str. 19
- materiál SILIKON	str. 19
- materiál NR	str. 19
- materiál PU	str. 19
- materiál MIKROPORÉZNÍ	str. 20
- materiál REGLANULÁT	str. 29

DESKY PODLAHOVÉ

- materiál PRYŽOVÉ	str. 45
- materiál PVC	str. 47
- materiál PLASTOVÉ	str. 48

GUMOVÉ ROHOŽE

- rohože před vstupní dveře	str. 52
- rohože	str. 55
- desky protiskluzové - mat. pvc	str. 57
- koupelňové protiskluzové rohože	str. 58

GUMOVÉ DESKY PRO KOŇSKÉ STÁJE

str. 59

BEZAZBESTOVÉ TĚSNÍČÍ DESKY ADISEAL

str. 61

DOPRAVNÍKOVÉ PÁSY

str. 62

PTFE - DESKY / TYČE / PÁSKY

str. 64

- desky	str. 64
- tyče	str. 64
- pásky	str. 65

SILENTBLOKY

str. 66

- TYP A	str. 67
- TYP B	str. 68
- TYP C	str. 69
- TYP D	str. 70
- TYP E	str. 71

ŠŇŮRY

str. 72

- materiál SILIKON	str. 73
- materiál FPM	str. 73
- materiál EPDM	str. 73
- materiál NBR	str. 74
- mikroporézní EPDM	str. 74

HADICE

str. 75

- zahradní hadice	str. 76
- hadice s textilním opletem	str. 77
- sací hadice s plastovou spirálou	str. 78
- hadice s kovovou spirálou	str. 79
- hadice jednoplášťové	str. 80
- hadice silikon	str. 82

BŘITY NA RADLICE

str. 83

ZÁVĚSNÉ PVC PÁSY

str. 84

PODLOŽKY PRO ZVEDÁKY

str. 85

HYDRAULICKÁ TĚSNĚNÍ

str. 86

- stírací kroužky	str. 87
- těsnění pístnice	str. 88
- vodící kroužky	str. 89
- těsnění pístu	str. 90
- statická těsnění	str. 91
- hřídelová těsnění	str. 92
- opěrné kroužky	str. 93

VODOVODNÍ TĚSNĚNÍ

str. 94

VYSEKÁVANÉ VÝROBKY

str. 96

LISOVANÉ VÝROBKY

str. 97

O-KROUŽKY

str. 98

PROFILY

str. 99

- silikonové - čtvercové / obdélníkové	str. 100
- dosedací	str. 102
- P	str. 103
- fasádní	str. 109
- spárové přechodové	str. 113
- H	str. 117
- D	str. 119
- s kovovou výztuhou	str. 128
- klínové	str. 132
- svěrní	str. 134
- korunové	str. 137
- ochranné / vratové	str. 139
- šňůry	str. 143
- C	str. 144
- hadice	str. 146
- U speciál	str. 147
- U	str. 148
- čtvercové	str. 165
- L	str. 168
- zárubní	str. 172

ADITEG s.r.o.

GUMOVÉ VÝROBKY

...těsní hned



www.aditeg.cz

V roce 2003 jsme založili společnost Aditeg s.r.o., kterou tehdy představovaly pouze kanceláře. Začali jsme razantně, sebevědomě a zdařile, proto jsme po třech letech působení na trhu přesídlili do Vrbovce, kde jsme vybudovali výrobní, skladové a distribuční centrum. Po zdařeném působení na trhu jsme zjistili, že dané výrobní, skladové a distribuční centrum je nutno dál rozšířit, a proto jsme v roce 2014 byli opět nuceni přesídlit do nových prostor, kde jsme vybudovali další kanceláře, výrobní, skladové a distribuční centrum. V následujícím roce 2017 jsme se opět rozšířili z kapacitních důvodů do 2 výrobních a skladovacích prostor.

Do nových hal jsme postupně pořídili stroje disponující nejmodernějšími výrobními technologiemi, a tím jsme zahájili rozšiřování našich výrobních možností.

Do našeho strojového parku patří:

- 6 CNC plotrů
- 2 stolní CNC frézky
- 1 CNC soustruh
- 3 sekací automatické mostové lisy
- 2 menší klasické sekací lisy
- 1 Kiss Cut
- 2 řezačky pásů
- 1 laminovací stroj
- 1 štípací stroj Bäumer
- 2 vstřikolisy
- 1 extruder profilů

Díky tomu Vám můžeme nabídnout lepší ceny a pružněji reagovat na Vaše požadavky.

V našem sortimentu najdete gumové výrobky z řady:

- desek
- silentbloků
- profilů
- O-kroužků
- plochých kroužků
- lisovaných výrobků
- vysekávaných výrobků a jiné

Naše zboží si můžete vybrat z:

- PRODUKTOVÉHO KATALOGU - jehož strukturu a skladbu jsme volili tak, aby byla přehledná a výběr z něj byl co nejkomfortnější
- E-SHOPU - který je součástí našich webových stránek (www.aditeg.cz)

Široká nabídka zboží skladem, velmi krátká dodací lhůta či zakázková výroba, to vše jsou atributy služeb společnosti Aditeg s.r.o.

Mezi naše spokojené zákazníky patří klienti jak na českém trhu, tak i po celém světě.

Disponujeme certifikací ISO 9001:2016 a 14001:2016 uznávanou pečeti kvality. Naše výrobky splňují tolerance rozměru a kvality dle příslušných norem. Kládeme důraz na vyvážený poměr mezi kvalitou a cenou, individuální přístup k zákazníkům, přizpůsobení výroby dle Vašich požadavků a včasné dodání. To vše jsou přednosti, které nám zajišťují stále více spokojených zákazníků.

Zajisté oceníte rodinné prostředí naší firmy a snahu dělat věci co nejlépe a věříme, že Vás naše zboží zaujme a bude užitečné jak pro Vás, tak pro Vaše klienty a zákazníky.

JSME JEDNIČKA VE VÝROBĚ TĚSNĚNÍ, TECHNICKÉ PRYŽE A DALŠÍCH GUMOVÝCH VÝROBKŮ

PROČ SE VÁM SPOLUPRÁCE S NÁMI VYPLATÍ?

- široká nabídka těsnění skladem
- velmi krátká dodací lhůta
- zakázková výroba na technickou pryž
- certifikace ISO 9001:2016
- certifikace ISO 14001:2016
- včasné dodání



Veškeré ceny v katalogu jsou uvedeny v Kč a bez DPH. Ceny jsou platné od vydání katalogu po vydání katalogu nového. Fotografie jsou ilustrační. Tiskové chyby a všechna práva vyhrazena.



GUMOVÉ ČESKY PROKONKOVÉ STAVBY
ADITEG s.r.o.
ADITEG. G jako guma, to je předtí pro vaše koně...
pomáháme vám
• s výběrem koní a stánek
• s výběrem koní, které nejlépe a zdravě žijí
• s výběrem koní, které nejlépe a zdravě žijí
• s výběrem koní, které nejlépe a zdravě žijí
• s výběrem koní, které nejlépe a zdravě žijí
...a to všechno na www.aditeg.cz
tel. +420 975 2122, fax +420 975 0224, e-mail: info@aditeg.cz

ADITEG s.r.o.
příjemně vstříbní

QMS
Kvalita je základem úspěchu

O NÁS



O NÁS





O NÁS

PŘÍRODNÍ KAUČUK (NR)

- + velmi dobrá elasticita a mechanické vlastnosti (pevnost, tažnost, odolnost proti oděru)
- + při namáhání - malá trvalá deformace, vysoká odolnost vůči střídavému ohybu
- špatná odolnost vůči oleji, ozónu, povětrnosti a horku
- hořlavý

STYRENBUTADIENOVÝ KAUČUK (SBR)

- + lepší odolnost proti oděru a stárí než NR
- + snáší krátkodobě vyšší teploty než NR
- jako NR, ale méně elastický, z čehož vyplývá malá odrazová pružnost a tím také velké zvýšení teplot
- při dynamickém namáhání, špatná vrubová pevnost, hořlavý

BUTYLOVÝ KAUČUK (IIR)

- + dobrá odolnost proti ozónu a povětrnostním podmínkám, velmi nízká propustnost plynů a vzduchu
- + dobré elektroizolační vlastnosti
- + dobré chování při nízkých teplotách, vysoce tlumící materiál pro aperiodické kmitání
- + dobrá odolnost vůči horké vodě a chemikáliím
- nízká odrazová pružnost, není odolný vůči olejům a tukům
- hořlavý

ETHYLEN-PROPYLEN KAUČUK (EPDM)

- + výborná odolnost vůči stárí, povětrnostním podmínkám, ozónu, chemikáliím, horké vodě, páře a polárním rozpouštědlům, např. aceton, metanol nebo estery
- + výborné elektroizolační vlastnosti
- + velmi dobrá odolnost vůči horku a zároveň dobré chování při nízkých teplotách
- máloodolnost vůči alifatickým a aromatickým uhlovodíkům (minerální oleje, benzín, pohonné látky)
- hořlavý

NITRILOVÝ KAUČUK (NBR)

- + velmi dobrá odolnost vůči olejům a benzínu, dobré mechanické vlastnosti, nízká trvalá deformace v tlaku
- + lepší odolnost vůči horku než SBR, nízká propustnost plynů
- špatná odolnost proti povětrnostním podmínkám, hořlavý s toxickými kouřovými plyny
- špatná odolnost vůči aromatickým a polárním rozpouštědlům

HYDRATOVANÝ NITRILOVÝ KAUČUK (HNBR)

- + velmi dobré mechanické vlastnosti, velmi dobrá odolnost vůči oděru a horku
- + velmi dobrá odolnost vůči stárí, ozónu a povětrnostním podmínkám
- + výborná odolnost vůči olejům, tukům a pohonným látkám, velmi dobrá odolnost vůči horké vodě a páře
- špatná odolnost vůči aromatickým a polárním rozpouštědlům
- špatné elektroizolační vlastnosti, hořlavý s toxickými kouřovými plyny

CHLOROPRENOVÝ KAUČUK (CR)

- + dobrá odolnost vůči horku, stárí, ozónu a povětrnostním podmínkám
- + průměrná odolnost vůči olejům, dobré mechanické vlastnosti a elasticita, vysoká odolnost vůči stř. ohybu
- + nehoří ve vlastním plameni
- u jednotlivých CR - typů dochází k menšímu či většímu samoztužení event. při nižší teplotě ke krystalizaci
- špatná odolnost vůči pohonným látkám

CHLORSULFONOVÝ POLYETYLEN (CSM)

- + dobrá odolnost vůči stárí, ozónu a povětrnostním podmínkám, nízká propustnost vzduchu
- + dobrá odolnost vůči chemikáliím (především u silně oxidovaných)
- špatná odolnost vůči nízkým teplotám
- špatná odolnost vůči pohonným látkám

ACRYLÁTOVÝ KAUČUK (ACM)

- + dobrá odolnost vůči stárí, ozónu a povětrnostním podmínkám
- + velmi dobrá odolnost vůči olejům, tukům a pohonným látkám
- + vysoká odolnost vůči horku
- špatná odolnost vůči chemikáliím, hydrolýze a nízkým teplotám
- špatné mechanické vlastnosti a nízká elasticita

POLYURETANOVÝ KAUČUK (PU)

- + dobrá odolnost vůči stárí, ozónu a povětrnostním podmínkám
- + velmi dobrá odolnost proti oděru, velmi dobrá vrubová a tahová pevnost
- + nízká propustnost plynů
- velmi citlivý na vodu, především při teplotě vyšší než 50°C
- při vyšších teplotách dochází k trvalé deformaci, hořlavý

SILIKONOVÝ KAUČUK (Q)

- + velmi dobrá odolnost vůči vysokým i nízkým teplotám
- + výborná odolnost proti stárí, ozónu a povětrnostním podmínkám
- + dobré elektroizolační vlastnosti, mechanické hodnoty zůstávají konstantní v široké oblasti teplot
- + fyziologicky bezvadný
- průměrné mechanické vlastnosti
- průměrná odolnost vůči oleji
- citlivý vůči horké vodě a páře
- špatná odolnost vůči pohonným látkám

FLUORSILIKONOVÝ KAUČUK (MFQ)

- + velmi dobrá odolnost vůči vysokým i nízkým teplotám
- + výborná odolnost proti stárí, ozónu a povětrnostním podmínkám
- + dobré elektroizolační vlastnosti, mechanické hodnoty zůstávají konstantní v široké oblasti teplot
- + dobrá odolnost vůči olejům a pohonným látkám
- průměrné mechanické vlastnosti
- velmi vysoká cena

FLUOROVÝ KAUČUK (FPM)

- + velmi vysoká odolnost vůči horku, vynikající odolnost vůči stárí, ozónu a povětrnostním podmínkám
- + velmi dobrá odolnost vůči chemikáliím, nízká propustnost plynů
- + nehoří ve vlastním plameni
- citlivý na působení horké vody, páry, kyselin, aminů a polárních rozpouštědel
- špatná odolnost při nízkých teplotách

POLYTETRAFLUORETHYLEN - TELFON (PTFE)

- + chemická odolnost
- + odolnost proti stárnutí a vysokým teplotám
- + nízká nasákavost a odolnost proti rozpouštědlům
- při větší dávce radioaktivního záření degraduje
- dobré kluzné vlastnosti

Gumové desky nachází své uplatnění v mnoha odvětvích průmyslu, kde lze využít izolačních, ochranných a tlumících vlastností. Dle technologie výroby, zvoleného materiálu a struktury povrchu desky rozdělujeme na: **PRYŽOVÉ, MIKROPORÉZNÍ a PODLAHOVÉ**

Na základě vlastností, mezi které patří mimo jiné vysoká tvárnost, pružnost, neprodyšnost, nenasákavost a mechanická odolnost, se liší způsob jejich využití.

Jsou nabízeny standardně v **ROLÍCH či DESKÁCH** požadovaného formátu. Standardní rozměr je 1200x10000mm skladem i šířky 1400/1500/1800/2000mm, ceny a dostupnost na vyžádání.

Vhodné jsou jak pro použití v exteriéru, tak v interiéru.

Sdělíte-li nám účel, ke kterému chcete desky užít, doporučíme Vám materiál s takovými vlastnostmi, které odpovídají požadované oblasti použití.

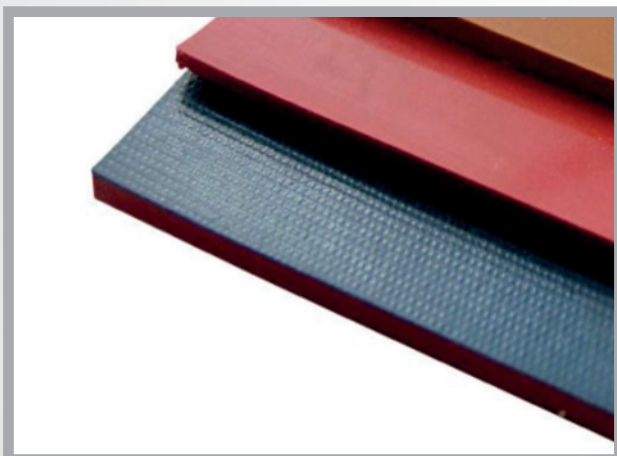
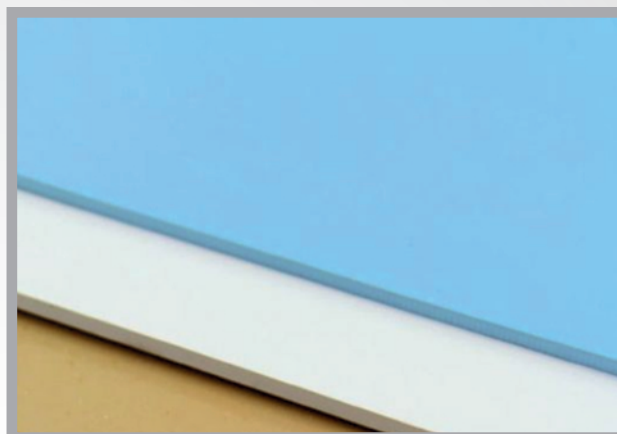

DESKY PRYŽOVÉ

MATERIÁL SBR



Pryžové desky se používají v mnoha odvětvích jako těsnící a dopadový element nebo slouží jako polotvar pro zhotovení různých těsnících a tlumících dílců, izolačních vrstev apod.

Vyrábějí se buď s povrchem hladkým nebo s texturou. Uvnitř mohou být desky zpevněny textilní vložkou. Standardně jsou dodávány v rolích nebo deskách v síle 0,1 - 50mm.

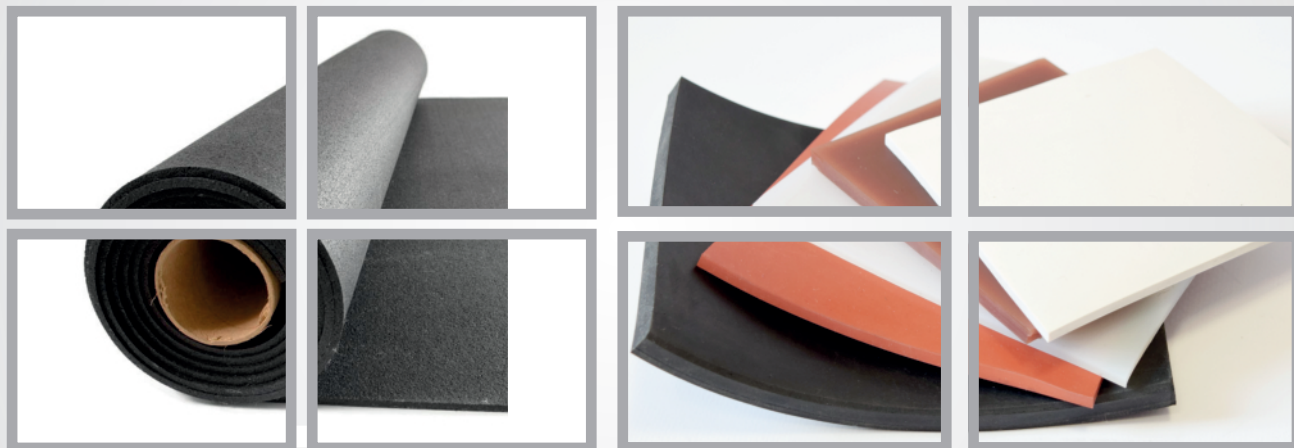

Neuvedené tloušťky pak dle konkrétních požadavků zákazníka. V závislosti na směsi mají pryžové desky i rozdílné vlastnosti, mechanickou odolnost, olejivzdornost, kyselinovzdornost a měrnou hmotnost. Dají se běžně tvarovat řezáním či vysekáváním.

SBR 65 +/- 10 Sh., 2-3 MPa		
tloušťka	Cena	
	1 - 11,99m ²	12 - 119,99m ²
1mm	90,90	50,70
1,5mm	145,20	79,20
2mm	185,90	101,30
2,5mm	241,90	132,00
3mm	278,40	151,80
3,5mm	338,40	184,50
4mm	371,50	191,30
5mm	464,20	239,00
6mm	557,10	286,80
8mm	742,70	382,40
10mm	942,10	485,10
12mm	958,40	493,50
15mm	1.197,60	616,70
20mm	1.595,90	821,80
25mm	1.995,50	1.027,60
30mm	2.393,80	1.320,70
40mm	3.191,80	1.761,00
50mm	3.989,70	2.201,30

SBR 65 +/- 10 Sh., 5 MPa		
tloušťka	Cena	
	1 - 11,99m ²	12 - 119,99m ²
1mm	142,50	73,30
1,5mm	213,70	110,10
2mm	286,40	147,50
2,5mm	347,90	179,20
3mm	417,40	214,90
3,5mm	486,10	250,30
4mm	555,60	286,10
5mm	695,20	358,00
6mm	833,30	429,20
8mm	1.112,60	572,90
10mm	1.390,40	715,90
12mm	1.668,20	859,00
15mm	2.085,60	1.074,00
20mm	2.782,20	1.432,70
25mm	3.477,50	1.790,60
30mm	4.172,70	2.148,70
40mm	5.564,50	2.865,30
50mm	6.954,90	3.581,40

SBR 65 +/- 10 Sh., 7-8 MPa		
tloušťka	Cena	
	1 - 11,99m ²	12 - 119,99m ²
1mm	217,10	133,60
1,5mm	294,90	181,50
2mm	393,30	242,10
2,5mm	491,60	302,60
3mm	590,40	363,40
3,5mm	688,80	424,00
4mm	786,60	484,20
5mm	982,80	604,90
6mm	1.179,90	726,30
8mm	1.572,30	967,80
10mm	1.965,60	1.209,80
12mm	2.358,80	1.452,00
15mm	2.948,30	1.814,70
20mm	3.931,10	2.419,60
25mm	4.911,10	3.022,80
30mm	6.975,70	3.628,90
40mm	7.861,30	4.838,70
50mm	9.825,80	6.048,00

ADI01 SBR 50 +/- 5 Sh., 4 MPa		
 tloušťka	Cena	
	1 - 11,99m ²	12 - 119,99m ²
1mm	198,00	110,10
2mm	396,00	220,00
3mm	594,00	330,00
4mm	792,00	440,00
5mm	990,00	550,00
6mm	1.188,00	660,00
8mm	1.584,00	880,00
10mm	1.980,00	1.100,00
12mm	2.376,00	1.320,00
15mm	2.970,00	1.650,00
20mm	3.960,00	2.200,00
25mm	4.950,00	2.750,00
30mm	5.940,00	3.300,00
40mm	7.920,00	4.400,00
50mm	9.900,00	5.500,00

ADI01 SBR 60 +/- 5 Sh., FDA světlá 6 MPa		
 tloušťka	Cena	
	1 - 11,99m ²	12 - 119,99m ²
1mm	684,00	380,10
2mm	1.368,00	760,00
3mm	2.052,00	1.140,00
4mm	2.736,00	1.520,00
5mm	3.420,00	1.900,00
6mm	4.104,00	2.280,00
8mm	5.472,00	3.040,00
10mm	6.840,00	3.800,00
12mm	8.208,00	4.560,00
15mm	10.260,00	5.700,00
20mm	13.680,00	7.600,00
25mm	17.100,00	9.470,80
30mm	20.520,00	11.400,00
40mm	27.360,00	15.200,00
50mm	34.200,00	19.000,00

ADI01 NR/SBR 70 +/- 5 Sh. s klouzkem, 3-4 MPa		
 tloušťka	Cena	
	1 - 11,99m ²	12 - 119,99m ²
1mm	156,00	86,60
2mm	312,00	173,30
3mm	435,60	242,00
4mm	580,80	321,80
5mm	726,00	403,40
6mm	871,20	483,90
8mm	1.161,60	645,30
10mm	1.452,00	806,70
12mm	1.742,40	968,00
15mm	2.178,00	1.210,00
20mm	2.904,00	1.613,30
25mm	3.630,00	2.016,70
30mm	4.356,00	2.420,00
40mm	5.808,00	3.226,70
50mm	7.260,00	4.033,40

SBR 65 +/- 10 Sh., 2-3 MPa 1x textilní vložka		
 tloušťka	Cena	
	1 - 11,99m ²	12 - 119,99m ²
2mm	225,30	104,90
2,5mm	281,60	131,10
3mm	338,70	157,70
3,5mm	395,20	183,90
4mm	450,60	209,70
5mm	564,00	262,50
6mm	675,80	314,60
8mm	901,00	419,50
10mm	1.126,30	524,30
12mm	1.426,10	663,90
15mm	1.780,40	828,80
20mm	2.377,00	1.106,60
25mm	2.971,20	1.383,20
30mm	3.565,40	1.659,70
40mm	4.753,90	2.213,00
50mm	5.942,40	2.766,30

SBR 65 +/- 10 Sh., 5 MPa 1x textilní vložka		
 tloušťka	Cena	
	1 - 11,99m ²	12 - 119,99m ²
2mm	388,40	180,80
2,5mm	437,00	226,00
3mm	526,60	245,20
3,5mm	554,30	286,60
4mm	703,70	327,60
5mm	879,30	409,30
6mm	1.054,80	491,10
8mm	1.407,60	655,20
10mm	1.760,20	819,40
12mm	2.111,30	982,80
15mm	2.639,50	1.228,70
20mm	3.520,40	1.638,80
25mm	4.400,50	2.048,50
30mm	5.280,60	2.458,20
40mm	7.040,70	3.277,60
50mm	8.801,00	4.097,00

SBR 65 +/- 10 Sh., 2-3 MPa 1x nylon vložka		
 tloušťka	Cena	
	1 - 11,99m ²	12 - 119,99m ²
2mm	356,50	166,00
2,5mm	413,90	192,70
3mm	461,40	214,80
3,5mm	511,70	238,20
4mm	565,20	263,10
5mm	668,70	311,40
6mm	772,50	359,60
8mm	979,90	456,20
10mm	1.187,40	552,70
12mm	1.394,70	649,30
15mm	1.706,90	794,70
20mm	2.250,00	1.047,40
25mm	2.812,50	1.309,30
30mm	3.299,80	1.536,10
40mm	4.444,00	2.068,70
50mm	5.518,40	2.568,90

**SBR 65 +/- 10 Sh., 2-3 MPa
2x textilní vložka**

tloušťka	Cena	
	1 - 11,99m ²	12 - 119,99m ²
4mm	576,70	268,50
5mm	721,20	335,80
6mm	865,70	403,10
8mm	1.154,70	537,50
10mm	1.443,60	672,10
12mm	1.731,50	806,00
15mm	2.164,90	1.007,70
20mm	2.886,20	1.343,50
25mm	3.607,60	1.679,40
30mm	4.329,80	2.015,60
40mm	5.893,50	2.743,50
50mm	7.367,40	3.429,60



...těsní hned

DESKY PRYŽOVÉ

MATERIÁL NBR

NBR/SBR 65 +/- 5 Sh., 2-3 MPa

tloušťka	Cena	
	1 - 11,99m ²	12 - 119,99m ²
1mm	167,20	89,20
1,5mm	241,90	124,10
2mm	310,00	165,30
2,5mm	372,50	198,70
3mm	466,20	248,70
3,5mm	522,00	278,50
4mm	621,20	331,30
5mm	776,20	414,00
6mm	931,20	496,70
8mm	1.242,40	662,40
10mm	1.552,40	828,00
12mm	1.862,40	993,30
15mm	2.327,30	1.241,20
20mm	3.103,50	1.655,20
25mm	4.078,10	2.069,10
30mm	4.655,90	2.482,90
40mm	6.206,90	3.310,50
50mm	7.759,30	4.138,10

NBR/SBR 65 +/- 5 Sh., 5 MPa

tloušťka	Cena	
	1 - 11,99m ²	12 - 119,99m ²
1mm	203,90	116,50
1,5mm	305,90	174,70
2mm	407,80	233,10
2,5mm	509,80	291,30
3mm	603,60	344,80
3,5mm	705,30	403,10
4mm	806,10	460,60
5mm	1.007,30	575,60
6mm	1.208,50	690,60
8mm	1.612,20	924,50
10mm	2.015,90	1.151,90
12mm	2.418,30	1.381,90
15mm	3.023,20	1.727,60
20mm	4.031,90	2.304,00
25mm	5.039,90	2.879,90
30mm	6.047,90	3.455,90
40mm	8.063,80	4.607,90
50mm	10.078,50	5.759,10

NBR/SBR 65 +/- 5 Sh., 7-8 MPa

tloušťka	Cena	
	1 - 11,99m ²	12 - 119,99m ²
1mm	282,40	161,40
1,5mm	390,00	222,80
2mm	519,90	297,10
2,5mm	649,90	371,40
3mm	780,00	445,70
3,5mm	909,90	519,90
4mm	1.039,90	594,20
5mm	1.298,90	742,20
6mm	1.559,80	891,30
8mm	2.078,90	1.187,90
10mm	2.598,80	1.485,00
12mm	3.118,70	1.782,10
15mm	3.897,70	2.227,30
20mm	5.197,60	2.970,00
25mm	6.497,00	3.712,50
30mm	7.796,30	4.455,10
40mm	10.478,70	5.987,80
50mm	13.096,90	7.484,00

ADI01 NBR 65 +/- 5 Sh. s klouzkem, 5 MPa		
 tloušťka	Cena	
	1 - 11,99m ²	12 - 119,99m ²
1mm	240,00	133,40
2mm	480,00	266,70
3mm	720,00	400,00
4mm	960,00	533,30
5mm	1.200,00	666,70
6mm	1.440,00	800,00
8mm	1.920,00	1.066,70
10mm	2.400,00	1.333,40
12mm	2.880,00	1.600,00
15mm	3.600,00	2.000,10
20mm	4.800,00	2.666,60
25mm	6.000,00	3.333,30
30mm	7.200,00	4.000,00
40mm	9.600,00	5.333,40
50mm	12.000,00	6.666,60

ADI01 NBR 60 +/- 5 Sh., FDA světla, 5 MPa		
 tloušťka	Cena	
	1 - 11,99m ²	12 - 119,99m ²
1mm	702,00	390,00
2mm	1.404,00	780,00
3mm	2.106,00	1.170,00
4mm	2.808,00	1.560,00
5mm	3.510,00	1.950,00
6mm	4.212,00	2.340,00
8mm	5.616,00	3.120,00
10mm	7.020,00	3.900,00
12mm	8.424,00	4.680,00
15mm	10.530,00	5.850,00
20mm	14.040,00	7.800,00
25mm	17.550,00	9.750,00
30mm	21.060,00	11.700,00
40mm	28.080,00	15.600,00
50mm	35.100,00	19.500,00

NBR/SBR 65 +/- 5 Sh., 2-3 MPa 1x textilní vložka		
 tloušťka	Cena	
	1 - 11,99m ²	12 - 119,99m ²
2mm	323,60	184,90
2,5mm	405,50	231,80
3mm	486,60	278,10
3,5mm	566,10	323,60
4mm	647,00	369,80
5mm	810,20	463,00
6mm	977,40	558,50
8mm	1.294,20	739,50
10mm	1.614,90	922,90
12mm	1.943,90	1.110,80
15mm	2.429,20	1.388,10
20mm	3.239,40	1.851,10
25mm	4.049,20	2.313,90
30mm	4.859,80	2.777,00
40mm	6.478,80	3.702,10
50mm	8.099,10	4.628,10

NBR/SBR 65 +/- 5 Sh., 5 MPa 1x textilní vložka		
 tloušťka	Cena	
	1 - 11,99m ²	12 - 119,99m ²
2mm	435,00	248,60
2,5mm	543,80	310,70
3mm	645,70	368,90
3,5mm	755,40	431,60
4mm	860,40	491,70
5mm	1.075,20	614,40
6mm	1.291,40	738,00
8mm	1.721,10	983,40
10mm	2.151,90	1.229,70
12mm	2.582,80	1.475,90
15mm	3.227,10	1.844,10
20mm	4.303,80	2.459,30
25mm	5.379,70	3.074,10
30mm	6.455,70	3.689,00
40mm	8.607,60	4.918,60
50mm	10.759,50	6.148,20

NBR/SBR 65 +/- 5 Sh., 2-3 MPa 1x nylon vložka		
 tloušťka	Cena	
	1 - 11,99m ²	12 - 119,99m ²
2mm	424,10	242,40
2,5mm	475,70	271,80
3mm	571,00	326,30
3,5mm	666,10	380,60
4mm	717,80	410,20
5mm	864,60	494,10
6mm	1.011,40	577,90
8mm	1.305,10	745,70
10mm	1.598,60	913,60
12mm	1.863,10	1.081,30
15mm	2.332,70	1.332,90
20mm	3.115,70	1.780,40
25mm	3.894,60	2.225,40
30mm	4.608,40	2.633,40
40mm	6.198,80	3.542,20
50mm	7.715,80	4.409,10

NBR/SBR 65 +/- 5 Sh., 2-3 MPa 2x textilní vložka		
 tloušťka	Cena	
	1 - 11,99m ²	12 - 119,99m ²
4mm	790,00	420,10
5mm	986,90	524,90
6mm	1.183,80	629,50
8mm	1.578,90	839,60
10mm	1.973,80	1.111,40
12mm	2.367,70	1.333,30
15mm	2.959,50	1.666,50
20mm	3.946,40	2.222,20
25mm	4.933,30	2.778,00
30mm	5.920,20	3.333,60
40mm	8.117,80	4.571,10
50mm	10.148,70	5.714,70

DESKY PRYŽOVÉ

MATERIÁL EPDM



EPDM/SBR 65 +/- 5 SH., 2-3 MPa		
tloušťka	Cena	
	1 - 11,99m ²	12 - 119,99m ²
1mm	133,80	95,60
1,5mm	203,40	145,30
2mm	248,00	177,10
2,5mm	313,20	223,70
3mm	373,00	266,40
3,5mm	438,30	313,10
4mm	486,20	355,00
5mm	621,00	443,60
6mm	745,00	532,10
8mm	993,90	710,00
10mm	1.241,90	887,10
12mm	1.489,90	1.064,20
15mm	1.861,80	1.330,10
20mm	2.482,80	1.773,40
25mm	3.103,70	2.216,90
30mm	3.724,70	2.660,50
40mm	4.965,50	3.546,80
50mm	6.207,40	4.433,90

EPDM/SBR 65 +/- 5 Sh., 5 MPa		
tloušťka	Cena	
	1 - 11,99m ²	12 - 119,99m ²
1mm	157,70	112,60
1,5mm	237,10	169,30
2mm	298,00	212,90
2,5mm	372,50	266,00
3mm	447,00	319,20
3,5mm	521,40	372,50
4mm	595,90	425,60
5mm	745,00	532,10
6mm	893,90	638,50
8mm	1.190,80	850,60
10mm	1.489,90	1.064,20
12mm	1.786,80	1.276,20
15mm	2.233,80	1.595,50
20mm	2.978,60	2.127,60
25mm	3.723,60	2.659,70
30mm	4.468,50	3.180,10
40mm	5.957,30	4.255,20
50mm	7.447,20	5.319,40

EPDM/SBR 65 +/- 5 Sh., 7-8 MPa		
tloušťka	Cena	
	1 - 11,99m ²	12 - 119,99m ²
1mm	251,00	151,80
1,5mm	376,60	227,90
2mm	462,20	279,60
2,5mm	577,30	349,30
3mm	693,30	419,50
3,5mm	808,80	489,30
4mm	924,40	559,30
5mm	1.154,50	698,50
6mm	1.386,60	838,90
8mm	1.847,90	1.118,00
10mm	2.310,00	1.397,60
12mm	2.772,30	1.677,30
15mm	3.464,60	2.096,20
20mm	4.620,00	2.795,40
25mm	5.775,10	3.494,10
30mm	6.930,10	4.193,00
40mm	9.314,50	5.635,70
50mm	11.641,60	7.043,80

EPDM/SBR 65 +/- 5 SH., 2-3 MPa 1x textilní vložka		
tloušťka	Cena	
	1 - 11,99m ²	12 - 119,99m ²
2mm	371,30	185,70
2,5mm	463,50	231,80
3mm	556,20	278,10
3,5mm	649,80	325,00
4mm	742,60	371,30
5mm	927,50	463,80
6mm	1.112,40	556,20
8mm	1.483,70	741,90
10mm	1.851,90	925,90
12mm	2.221,60	1.110,80
15mm	2.776,20	1.388,10
20mm	3.702,10	1.851,10
25mm	4.627,80	2.313,90
30mm	5.554,00	2.777,00
40mm	7.404,40	3.702,10
50mm	9.256,10	4.628,10

EPDM/SBR 65 +/- 5 Sh., 5 MPa 1x textilní vložka		
tloušťka	Cena	
	1 - 11,99m ²	12 - 119,99m ²
2mm	402,70	253,60
2,5mm	498,20	313,60
3mm	597,80	376,40
3,5mm	697,00	438,90
4mm	796,60	501,60
5mm	995,40	626,70
6mm	1.195,50	752,70
8mm	1.593,10	1.003,10
10mm	1.992,10	1.254,20
12mm	2.390,90	1.505,40
15mm	2.987,40	1.880,90
20mm	3.984,10	2.508,50
25mm	4.980,10	3.135,60
30mm	5.976,10	3.762,70
40mm	7.968,10	5.017,00
50mm	9.960,20	6.271,20

EPDM/SBR 65 +/- 5 Sh., 2-3 MPa 1x nylon vložka		
tloušťka	Cena	
	1 - 11,99m ²	12 - 119,99m ²
2mm	433,90	248,00
2,5mm	488,60	279,20
3mm	586,20	335,00
3,5mm	645,80	369,00
4mm	738,20	421,80
5mm	889,10	508,00
6mm	1.040,90	594,90
8mm	1.344,70	768,40
10mm	1.647,50	941,40
12mm	1.951,30	1.115,10
15mm	2.442,70	1.395,90
20mm	3.213,50	1.836,30
25mm	4.017,00	2.295,40
30mm	4.828,50	2.759,20
40mm	6.394,50	3.654,00
50mm	7.960,50	4.548,90

DESKY PRYŽOVÉ

ADI01 EPDM 65 +/- 5 Sh.		
tloušťka	Cena	
	1 - 11,99m ²	12 - 119,99m ²
1mm	270,00	150,00
2mm	540,00	300,00
3mm	810,00	450,00
4mm	1.080,00	600,00
5mm	1.350,00	750,00
6mm	1.620,00	900,00
8mm	2.160,00	1.200,00
10mm	2.700,00	1.500,00
12mm	3.240,00	1.800,00
15mm	4.050,00	2.250,00
20mm	5.400,00	3.000,00
25mm	6.750,00	3.750,00
30mm	8.100,00	4.500,00
40mm	10.800,00	6.000,00
50mm	13.500,00	7.500,00

ADI01 EPDM 60 +/- 5 Sh., FDA		
tloušťka	Cena	
	1 - 11,99m ²	12 - 119,99m ²
1mm	894,00	496,70
2mm	1.788,00	993,40
3mm	2.682,00	1.490,00
4mm	3.576,00	1.986,70
5mm	4.470,00	2.483,40
6mm	5.364,00	2.980,00
8mm	7.152,00	3.973,30
10mm	8.940,00	4.966,70
12mm	10.728,00	5.960,00
15mm	13.410,00	7.449,90
20mm	17.800,00	9.933,30
25mm	22.350,00	12.416,70
30mm	26.820,00	14.900,00
40mm	35.760,00	19.866,70
50mm	44.700,00	24.833,30

EPDM/SBR 65 +/- 5 Sh., 2-3 MPa, 2x textilní vložka		
tloušťka	Cena	
	1 - 11,99m ²	12 - 119,99m ²
4mm	823,80	438,00
5mm	1.028,80	547,10
6mm	1.235,10	656,90
8mm	1.646,40	875,60
10mm	2.057,70	1.158,70
12mm	2.469,00	1.390,30
15mm	3.086,50	1.738,00
20mm	4.115,40	2.317,40
25mm	5.144,30	2.896,70
30mm	6.173,10	3.476,10
40mm	8.345,10	4.699,10
50mm	10.430,60	5.873,50

DESKY PRYŽOVÉ

MATERIÁL CR

DESKY PRYŽOVÉ

CR/SBR 65 +/- 5 Sh., 2-3 MPa		
tloušťka	Cena	
	1 - 11,99m ²	12 - 119,99m ²
1mm	167,30	95,60
1,5mm	255,50	146,00
2mm	310,00	177,10
2,5mm	286,70	225,60
3mm	466,30	266,40
3,5mm	552,40	315,70
4mm	621,30	355,00
5mm	776,30	443,60
6mm	931,20	532,10
8mm	1.242,40	710,00
10mm	1.396,10	797,80
12mm	1.552,40	887,10
15mm	1.862,40	1.064,20
20mm	2.483,20	1.419,00
25mm	2.909,10	1.662,30
30mm	3.103,50	1.773,50
40mm	4.137,90	2.364,60
50mm	5.173,20	2.956,20

CR/SBR 65 +/- 5 Sh., 5 MPa		
tloušťka	Cena	
	1 - 11,99m ²	12 - 119,99m ²
1mm	197,10	112,60
1,5mm	232,40	132,80
2mm	372,50	212,90
2,5mm	465,60	266,00
3mm	558,70	319,20
3,5mm	651,80	372,50
4mm	745,00	425,60
5mm	931,20	532,10
6mm	1.117,40	638,50
8mm	1.488,60	850,60
10mm	1.862,40	1.064,20
12mm	2.233,40	1.276,20
15mm	2.791,80	1.595,30
20mm	3.723,30	2.127,60
25mm	4.654,30	2.659,60
30mm	5.585,00	3.191,40
40mm	7.446,70	4.255,20
50mm	9.308,30	5.319,00

CR/SBR 65 +/- 5 Sh., 7-8 MPa		
tloušťka	Cena	
	1 - 11,99m ²	12 - 119,99m ²
1mm	282,40	161,40
1,5mm	390,00	222,80
2mm	519,90	297,10
2,5mm	649,90	371,40
3mm	780,00	445,70
3,5mm	909,90	519,90
4mm	1.039,90	594,20
5mm	1.298,90	742,20
6mm	1.559,80	891,30
8mm	2.078,80	1.187,90
10mm	2.598,80	1.485,00
12mm	3.118,70	1.782,10
15mm	3.897,70	2.227,30
20mm	5.197,60	2.970,00
25mm	6.497,00	3.712,50
30mm	7.796,30	4.455,10
40mm	10.478,70	5.987,80
50mm	13.096,90	7.484,00

CR/SBR 65 +/- 5 Sh., 2-3 MPa 1x textilní vložka		
tloušťka	Cena	
	1 - 11,99m ²	12 - 119,99m ²
2mm	369,80	246,50
2,5mm	463,40	309,00
3mm	556,20	370,80
3,5mm	647,00	431,40
4mm	739,50	493,00
5mm	925,90	617,30
6mm	1.117,00	744,70
8mm	1.479,00	986,00
9mm	1.660,70	1.107,20
10mm	1.845,60	1.230,40
12mm	2.221,60	1.481,10
15mm	2.776,20	1.850,80
20mm	3.702,10	2.468,10
25mm	4.627,70	3.085,10
30mm	5.554,00	3.702,70
40mm	7.404,40	4.936,20
50mm	9.256,10	6.170,80

CR/SBR 65 +/- 5 Sh., 5 MPa 1x textilní vložka		
tloušťka	Cena	
	1 - 11,99m ²	12 - 119,99m ²
2mm	460,60	263,20
2,5mm	575,70	329,00
3mm	683,60	390,60
3,5mm	799,70	456,90
4mm	911,10	520,70
5mm	1.138,50	650,60
6mm	1.367,40	781,40
8mm	1.822,20	1.041,20
10mm	2.278,50	1.301,90
12mm	2.734,80	1.562,80
15mm	3.417,00	1.952,50
20mm	4.557,00	2.604,00
25mm	5.696,10	3.255,00
30mm	6.835,40	3.905,90
40mm	9.113,90	5.208,00
50mm	11.392,40	6.509,90

CR/SBR 65 +/- 5 Sh., 2-3MPa 1x nylon vložka		
tloušťka	Cena	
	1 - 11,99m ²	12 - 119,99m ²
2mm	551,00	257,10
2,5mm	620,40	289,50
3mm	744,40	347,40
3,5mm	820,20	382,80
4mm	937,30	437,40
5mm	1.128,90	526,80
6mm	1.321,80	616,90
8mm	1.707,60	796,90
10mm	2.092,20	976,30
12mm	2.478,00	1.156,40
15mm	3.102,00	1.447,60
20mm	4.080,70	1.904,40
25mm	5.100,80	2.380,40
30mm	6.131,40	2.861,40
40mm	8.120,00	3.789,30
50mm	10.108,60	4.717,30

CR/SBR 65 +/- 5 Sh., 2-3 MPa 2x textilní vložka		
tloušťka	Cena	
	1 - 11,99m ²	12 - 119,99m ²
4mm	790,00	378,10
5mm	986,90	472,40
6mm	1.183,80	566,60
8mm	1.578,90	755,70
10mm	1.973,80	944,80
12mm	2.367,70	1.133,20
15mm	2.959,50	1.416,50
20mm	3.946,40	1.888,90
25mm	4.933,10	2.361,20
30mm	5.920,20	2.833,60
40mm	8.117,80	3.885,40
50mm	10.148,70	4.857,50

DESKY PRYŽOVÉ

MATERIÁL FPM / SILIKON / NR / PU

FPM 70 +/- 5 Sh.		
tloušťka	Cena	
	1 - 11,99m ²	12 - 119,99m ²
1mm	4.000,30	2.165,60
1,5mm	5.789,30	3.134,10
2mm	7.719,10	4.178,70
2,5mm	9.648,90	5.223,40
3mm	11.578,70	6.268,10
3,5mm	13.508,40	7.312,00
4mm	15.438,30	8.357,60
5mm	19.295,70	10.445,80
6mm	23.126,50	12.519,60
8mm	30.844,50	16.697,80
10mm	38.595,60	20.893,90
12mm	46.314,70	25.072,60
15mm	57.893,40	31.340,70
20mm	77.191,20	41.787,70

Silikon 60 +/- 5 Sh., bílá, červená, transparentní, zelená		
tloušťka	Cena	
	1 - 11,99m ²	12 - 119,99m ²
1mm	834,20	476,70
1,5mm	1.217,10	695,50
2mm	1.622,70	927,30
2,5mm	2.028,60	1.159,20
3mm	2.434,10	1.390,90
3,5mm	2.840,20	1.622,90
4mm	3.245,90	1.854,80
5mm	4.056,80	2.318,10
6mm	4.868,10	2.781,80
8mm	5.980,00	3.417,10
10mm	8.113,40	4.636,20
12mm	9.736,10	5.563,50
15mm	12.170,20	6.954,30
20mm	16.226,80	9.272,40

NR/SBR 50 +/- 5 Sh., šedá / bílá		
tloušťka	Cena	
	1 - 11,99m ²	12 - 119,99m ²
1mm	315,10	225,10
1,5mm	472,70	337,60
2mm	630,30	450,10
2,5mm	787,90	562,80
3mm	946,40	676,00
3,5mm	1.103,90	788,50
4mm	1.261,50	901,00
5mm	1.576,60	1.126,10
6mm	1.891,70	1.351,30
8mm	2.837,20	2.026,50
10mm	3.152,30	2.251,70
12mm	3.782,60	2.701,80
15mm	4.728,90	3.377,80
20mm	6.304,60	4.503,30
25mm	7.880,80	5.629,10
30mm	9.456,90	6.755,00
40mm	12.609,20	9.006,60
50mm	15.761,50	11.258,20

ADI01 NR 40 +/- 5 Sh. šedá / béžová		
tloušťka	Cena	
	1 - 11,99m ²	12 - 119,99m ²
1mm	823,20	457,40
1,5mm	1.234,80	686,00
2mm	1.646,40	914,70
2,5mm	2.058,00	1.143,30
3mm	2.469,60	1.372,00
3,5mm	3.292,80	1.829,30
4mm	4.116,00	2.286,70
5mm	4.939,20	2.744,00
6mm	6.585,60	3.658,70
8mm	8.232,00	4.573,40
10mm	12.348,00	6.860,10
12mm	16.464,00	9.146,60
15mm	20.580,00	11.433,30
20mm	24.696,00	13.720,00
25mm	20.580,00	11.433,30
30mm	24.696,00	13.720,00
40mm	32.928,00	18.293,40
50mm	41.160,00	22.866,60

PU 70 70 +/- 5 Sh., hnědá		
tloušťka	Cena	
	1 - 11,99m ²	12 - 119,99m ²
1mm	599,80	556,90
1,5mm	839,10	779,20
2mm	1.108,90	1.029,80
2,5mm	1.377,50	1.279,20
3mm	1.619,30	1.503,60
4mm	2.158,20	2.004,00
5mm	2.668,40	2.477,80
6mm	3.175,80	2.948,90
8mm	4.209,10	3.908,50
10mm	4.973,50	4.618,30
12mm	6.217,50	5.773,40
15mm	7.461,40	6.928,50
20mm	9.948,90	9.238,30

DESKY PRYŽOVÉ

MIKROPORÉZNÍ



Desky z pórovité pryžové směsi se vyznačují nízkou tepelnou vodivostí, malou tvrdostí, vysokou pružností, neprodyšností či nenasákavostí. Díky těmto vlastnostem nabízí široké spektrum využití převážně ve strojírenství a vzduchotechnice jako tepelný izolant, těsnící prvek nebo tlumič vibrací a hluku.

Zpracovávají se mnoha způsoby, například vysekáváním, vyřezáváním, lepením atd. Mohou přijít do styku s neagresivními látkami jako je dřevo, pryž, sklo, voda, textil apod.

Některé desky mohou být opatřeny samolepící vrstvou pro jednodušší připevnění k podkladu. Povrch podkladu musí být suchý, odmaštěný a hladký.

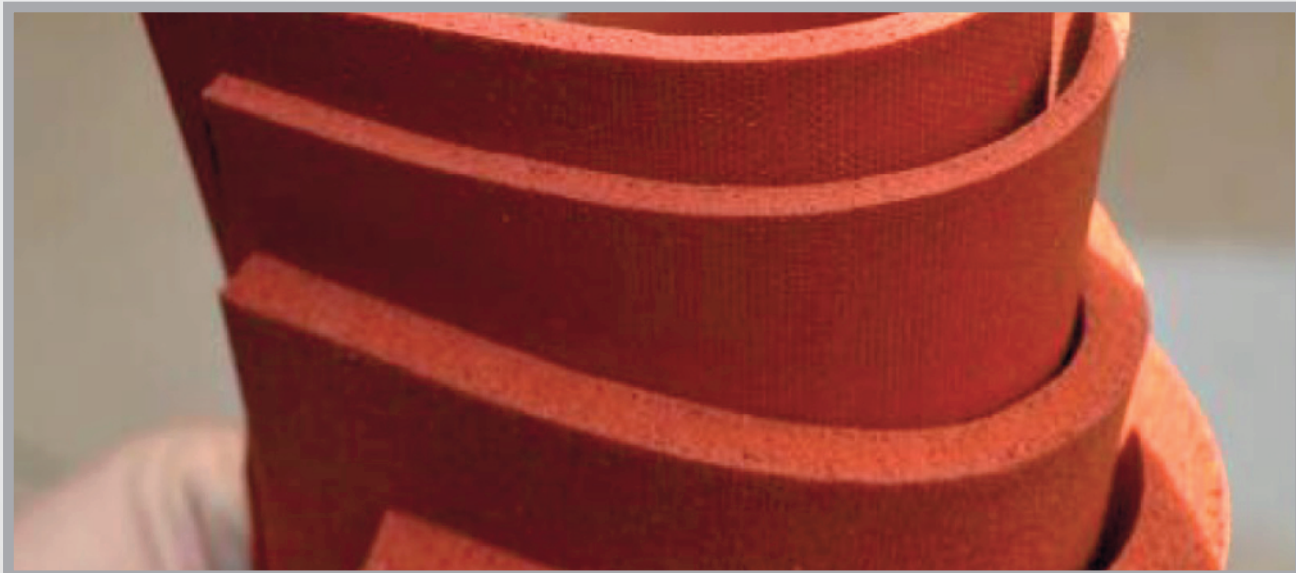

DESKY PRYŽOVÉ

MIKROPORÉZNI

Mikroporézní CR - černá 2000x1000mm - 140 +/- 25kg/m ³		
tloušťka	Cena	
	1 - 9,99m ²	od 10m ²
1mm	100,70	80,60
2mm	172,10	137,70
3mm	243,60	194,90
4mm	315,00	252,00
5mm	386,50	309,20
6mm	457,90	366,30
7mm	529,30	423,50
8mm	600,80	480,60
9mm	672,20	537,80
10mm	751,90	601,50
11mm	823,40	658,70
12mm	894,80	715,80
13mm	966,20	773,00
14mm	1.037,70	830,20
15mm	1.109,10	887,30
16mm	1.180,60	944,50
18mm	1.323,50	1.058,80
20mm	1.503,80	1.203,10
25mm	1.861,10	1.488,80
30mm	2.218,30	1.774,60
40mm	2.932,70	2.346,10
50mm	3.647,10	2.917,70

Mikroporézní CR - černá 2000x1000mm - 175 +/- 25kg/m ³		
tloušťka	Cena	
	1 - 9,99m ²	od 10m ²
1mm	126,70	101,40
2mm	224,20	179,40
3mm	321,70	257,40
4mm	419,20	335,40
5mm	516,70	413,40
6mm	614,20	491,30
7mm	711,70	569,30
8mm	809,20	647,30
9mm	906,60	725,30
10mm	1.012,40	809,90
11mm	1.109,90	887,90
12mm	1.207,40	965,90
13mm	1.304,90	1.043,90
14mm	1.402,30	1.121,90
15mm	1.499,80	1.199,90
16mm	1.597,30	1.277,90
18mm	1.792,30	1.433,80
20mm	2.024,80	1.619,80
25mm	2.512,20	2.009,80
30mm	2.999,70	2.399,70
40mm	3.974,50	3.179,60
50mm	4.949,40	3.959,50

Mikroporézní CR - šedá 1900x1000mm - 195 +/- 25kg/m ³		
tloušťka	Cena	
	1 - 9,99m ²	od 10m ²
1mm	231,40	185,10
2mm	433,60	346,80
3mm	635,70	508,60
4mm	837,90	670,30
5mm	1.040,00	832,00
6mm	1.242,20	993,70
7mm	1.444,30	1.155,50
8mm	1.646,50	1.317,20
9mm	1.848,60	1.478,90
10mm	2.059,00	1.647,20
11mm	2.261,20	1.809,00
12mm	2.463,40	1.970,70
13mm	2.666,50	2.132,40
14mm	2.867,70	2.294,10
15mm	3.069,80	2.455,90
16mm	3.272,00	2.617,60
18mm	3.676,30	2.941,00
20mm	4.118,10	3.294,50
25mm	5.128,90	4.103,10
30mm	6.139,60	4.911,70

Mikroporézní silikon 430kg/m ³ 1000x2000mm				
tloušťka	Cena			
	0,9 - 9,99m ²	10 - 24,99m ²	25 - 99,99m ²	od 100m ²
1,5mm	583,64	535,00	493,85	458,57
2mm	627,27	575,00	530,77	492,86
3mm	763,64	700,00	646,15	600,00
4mm	861,82	790,00	729,23	677,14
5mm	1.074,55	985,00	909,23	844,29
6mm	1.298,18	1.190,00	1.098,46	1.020,00
8mm	1.600,00	1.476,92	1.371,43	1.280,00
9mm	1.755,00	1.638,46	1.521,43	1.420,00
10mm	1.970,00	1.818,46	1.688,57	1.576,00
12mm	2.380,00	2.196,92	2.040,00	1.904,00
15mm	2.955,00	2.727,69	2.532,86	2.364,00
16mm	3.155,00	2.912,31	2.704,29	2.524,00
18mm	3.550,00	3.276,92	3.042,86	2.840,00
20mm	3.940,00	3.636,92	3.377,14	3.152,00
25mm	4.925,00	4.546,15	4.221,43	3.940,00

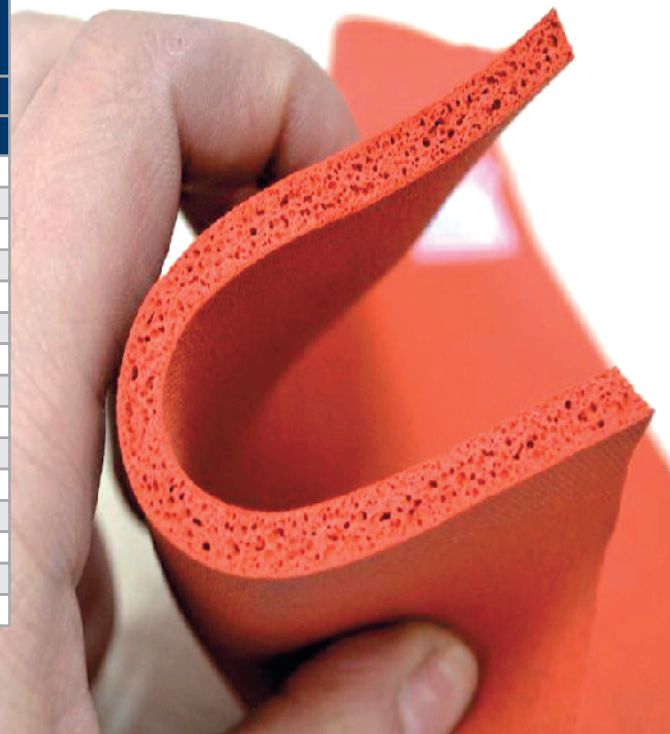

Mikroporézní NBR 2000x1000mm - 130 +/- 25kg/m ³		
tloušťka	Cena	
	1 - 9,99m ²	od 10m ²
1mm	141,90	113,50
2mm	254,60	203,70
3mm	367,30	293,80
4mm	480,00	384,00
5mm	592,70	474,10
6mm	705,30	564,30
7mm	818,00	654,40
8mm	930,70	744,60
9mm	1.043,40	834,70
10mm	1.164,30	931,50
11mm	1.277,00	1.021,60
12mm	1.389,70	1.111,70
13mm	1.502,40	1.201,90
14mm	1.615,00	1.292,00
15mm	1.727,70	1.382,20
16mm	1.840,40	1.472,30
18mm	2.065,80	1.652,60
20mm	2.328,60	1.862,90
25mm	2.892,00	2.313,60
30mm	3.455,40	2.764,40
40mm	4.582,30	3.665,80
50mm	5.709,10	4.567,30

Mikroporézní NBR 2000x1000mm - 165 +/- 25kg/m ³		
tloušťka	Cena	
	1 - 9,99m ²	od 10m ²
1mm	162,40	129,90
2mm	295,50	236,40
3mm	428,60	342,90
4mm	561,80	449,40
5mm	694,90	555,90
6mm	828,00	662,40
7mm	961,20	768,90
8mm	1.094,30	875,40
9mm	1.227,40	981,90
10mm	1.368,80	1.095,00
11mm	1.501,90	1.201,50
12mm	1.635,10	1.308,10
13mm	1.768,20	1.414,60
14mm	1.901,30	1.521,10
15mm	2.034,50	1.627,60
16mm	2.167,60	1.734,10
18mm	2.433,80	1.947,10
20mm	2.737,60	2.190,10
25mm	3.403,30	2.722,60
30mm	4.068,90	3.255,10
40mm	5.400,20	4.320,20
50mm	6.731,50	5.385,20

Mikroporézní NBR 1550x970mm - 180 +/- 25kg/m ³		
tloušťka	Cena	
	1 - 9,99m ²	od 10m ²
1mm	186,20	149,00
2mm	343,20	274,60
3mm	500,20	400,20
4mm	657,20	525,80
5mm	814,20	651,40
6mm	971,20	777,00
7mm	1.128,20	902,60
8mm	1.285,20	1.028,20
9mm	1.442,20	1.153,80
10mm	1.607,50	1.286,00
11mm	1.764,50	1.411,60
12mm	1.921,50	1.537,20
13mm	2.078,50	1.662,80
14mm	2.235,50	1.788,40
15mm	2.392,50	1.914,00
16mm	2.549,50	2.039,60
18mm	2.863,50	2.290,80
20mm	3.215,00	2.572,00
25mm	3.999,90	3.200,00
30mm	4.784,90	3.827,90
40mm	6.354,90	5.083,90
50mm	7.924,90	6.339,90

Mikroporézní NBR 1400x850mm - 295 +/- 25kg/m ³		
tloušťka	Cena	
	1 - 9,99m ²	od 10m ²
1mm	268,20	214,60
2mm	507,10	405,70
3mm	746,10	596,90
4mm	985,00	788,00
5mm	1.224,00	979,20
6mm	1.462,90	1.170,40
7mm	1.701,90	1.361,50
8mm	1.940,80	1.552,70
9mm	2.179,80	1.743,80
10mm	2.427,00	1.941,06
11mm	2.665,90	2.132,80
12mm	2.904,90	2.323,90
13mm	3.143,80	2.515,10
14mm	3.382,80	2.706,20
15mm	3.621,70	2.897,40
16mm	3.860,70	3.088,60
18mm	4.338,60	3.470,90
20mm	4.854,00	3.883,20
25mm	6.048,70	4.839,00
30mm	7.243,50	5.794,80
40mm	9.633,00	7.706,40
50mm	12.022,50	9.618,00



Mikroporézní EPDM 2000x1000mm - 75 +/- 15kg/m ³		
tloušťka	Cena	
	1 - 9,99m ²	od 10m ²
1mm	70,00	57,30
2mm	114,00	93,30
3mm	158,00	129,30
4mm	202,00	165,30
5mm	246,00	201,30
6mm	290,00	237,30
7mm	334,00	273,30
8mm	378,00	309,30
9mm	422,00	345,30
10mm	473,30	387,30
11mm	517,30	423,30
12mm	561,30	459,30
13mm	605,30	495,30
14mm	649,30	531,30
15mm	693,30	567,30
16mm	737,30	603,30
18mm	825,30	675,30
20mm	946,70	774,50
25mm	1.166,70	954,50
30mm	1.386,70	1.134,50
40mm	1.826,70	1.494,50
50mm	2.266,70	1.854,50

Mikroporézní EPDM 2000x1000mm - 90 +/- 20kg/m ³		
tloušťka	Cena	
	1 - 9,99m ²	od 10m ²
1mm	72,20	59,10
2mm	118,30	96,80
3mm	164,50	134,60
4mm	210,70	172,40
5mm	256,90	210,20
6mm	303,00	247,90
7mm	349,20	285,70
8mm	395,40	323,50
9mm	441,60	361,30
10mm	495,10	405,00
11mm	541,20	442,80
12mm	587,40	480,60
13mm	633,60	518,40
14mm	679,70	556,20
15mm	725,90	593,90
16mm	772,10	631,70
18mm	864,40	707,30
20mm	990,10	810,10
25mm	1.221,00	999,00
30mm	1.451,80	1.187,90
40mm	1.913,60	1.565,60
50mm	2.375,30	1.943,40

Mikroporézní EPDM 2000x1000mm - 115 +/- 25kg/m ³		
tloušťka	Cena	
	1 - 9,99m ²	od 10m ²
1mm	64,90	53,10
2mm	103,80	84,90
3mm	142,70	116,80
4mm	181,60	148,60
5mm	220,50	180,40
6mm	259,40	212,20
7mm	298,30	244,10
8mm	337,20	275,90
9mm	376,10	307,70
10mm	422,30	345,50
11mm	461,20	377,40
12mm	500,10	409,20
13mm	539,00	441,00
14mm	577,90	472,80
15mm	616,80	504,70
16mm	655,70	536,50
18mm	733,50	600,10
20mm	844,60	691,10
25mm	1.039,10	850,20
30mm	1.233,60	1.009,30
40mm	1.622,60	1.327,60
50mm	2.011,60	1.645,90

Mikroporézní EPDM 2000x1000mm - 130 +/- 20kg/m ³		
tloušťka	Cena	
	1 - 9,99m ²	od 10m ²
1mm	73,10	59,80
2mm	120,20	98,40
3mm	167,40	136,90
4mm	214,50	175,50
5mm	261,60	214,00
6mm	308,70	252,60
7mm	355,80	291,10
8mm	403,00	329,70
9mm	450,10	368,30
10mm	504,50	412,80
11mm	551,70	451,40
12mm	598,80	489,90
13mm	645,90	528,50
14mm	693,00	567,00
15mm	740,20	605,60
16mm	787,30	644,10
18mm	881,50	721,20
20mm	1.009,10	825,60
25mm	1.244,70	1.018,40
30mm	1.480,30	1.211,20
40mm	1.951,50	1.596,70
50mm	2.422,70	1.982,20

Mikroporézní EPDM 1600x1000mm - 175 +/- 25kg/m ³		
tloušťka	Cena	
	1 - 9,99m ²	od 10m ²
1mm	104,70	83,70
2mm	180,10	144,00
3mm	255,50	204,40
4mm	330,90	264,70
5mm	406,30	325,00
6mm	481,70	385,30
7mm	557,10	445,70
8mm	632,50	506,00
9mm	707,90	566,30
10mm	791,50	633,20
11mm	866,90	693,50
12mm	942,30	753,90
13mm	1.017,70	814,20
14mm	1.093,10	874,50
15mm	1.168,50	934,80
16mm	1.243,90	995,20
18mm	1.394,70	1.115,80
20mm	1.583,10	1.266,40
25mm	1.960,10	1.568,10
30mm	2.337,10	1.869,70
40mm	3.091,10	2.472,90
50mm	3.845,10	3.076,10

Mikroporézní deska PE

Mikroporézní deska, uzavřené póry s výbornou pružností. **Barvy:** černá, žlutá, červená, modrá, zelená.

Odolnost: Odolná vůči povětrnostním vlivům a UV záření. Odolná olejům a mírně odolná kyselinám.

Mikroporézní PE 33kg/m ³ 2000x1000mm - bílá + antracit		
tloušťka	Cena	
	1 - 9,99m ²	10 - 99,99m ²
1mm	31,30	28,90
2mm	43,20	39,90
3mm	55,00	50,80
4mm	66,90	61,70
5mm	78,70	72,70
6mm	90,50	83,60
7mm	102,40	94,50
8mm	114,20	105,40
9mm	126,10	116,40
10mm	143,40	132,40
11mm	155,30	143,30
12mm	167,10	154,20
13mm	178,90	165,20
14mm	190,80	176,10
15mm	202,60	187,00
16mm	214,50	198,00
18mm	238,10	219,80
20mm	286,80	264,80
25mm	346,00	319,40
30mm	405,20	374,10
40mm	523,70	483,40
50mm	642,10	592,70

Mikroporézní PE 33kg/m ³ 2000x1000mm - barevné		
tloušťka	Cena	
	1 - 9,99m ²	10 - 99,99m ²
1mm	32,50	30,00
2mm	45,50	42,00
3mm	58,40	54,00
4mm	71,40	65,90
5mm	84,40	77,90
6mm	97,40	89,90
7mm	110,40	101,90
8mm	123,40	113,90
9mm	136,30	125,90
10mm	154,80	142,90
11mm	167,80	154,90
12mm	180,80	166,90
13mm	193,80	178,90
14mm	206,80	190,90
15mm	219,70	202,80
16mm	232,70	214,80
18mm	258,70	238,80
20mm	309,70	285,80
25mm	374,60	345,80
30mm	439,50	405,70
40mm	569,30	525,50
50mm	699,10	645,40

Mikroporézní PE 45kg/m ³ 2000x1000mm - bílá + antracit		
tloušťka	Cena	
	1 - 9,99m ²	10 - 99,99m ²
1mm	34,70	32,00
2mm	49,90	46,10
3mm	65,10	60,10
4mm	80,30	74,10
5mm	95,50	88,10
6mm	110,70	102,20
7mm	125,90	116,20
8mm	141,10	130,20
9mm	156,30	144,30
10mm	177,00	163,40
11mm	192,20	177,40
12mm	207,40	191,40
13mm	222,60	205,50
14mm	237,80	219,50
15mm	253,00	233,50
16mm	268,20	247,50
18mm	298,60	275,60
20mm	354,00	326,70
25mm	429,90	396,90
30mm	505,90	467,00
40mm	657,90	607,30
50mm	809,90	747,60

Mikroporézní PE 45kg/m ³ 2000x1000mm - barevné		
tloušťka	Cena	
	1 - 9,99m ²	10 - 99,99m ²
1mm	36,20	33,40
2mm	52,80	48,80
3mm	69,50	64,20
4mm	86,20	79,60
5mm	102,90	95,00
6mm	119,50	110,40
7mm	136,20	125,70
8mm	152,90	141,10
9mm	169,60	156,50
10mm	191,70	177,00
11mm	208,40	192,40
12mm	225,10	207,80
13mm	241,80	223,20
14mm	258,40	238,60
15mm	275,10	254,00
16mm	291,80	269,30
18mm	325,10	300,10
20mm	383,50	354,00
25mm	466,90	431,00
30mm	550,20	507,90
40mm	717,00	661,80
50mm	883,70	815,80

Mikroporézní PE 60kg/m ³ 2000x1000mm - bílá + antracit		
tloušťka	Cena	
	1 - 9,99m ²	10 - 99,99m ²
1mm	41,40	40,20
2mm	63,30	62,40
3mm	85,20	84,60
4mm	107,10	106,80
5mm	129,10	129,00
6mm	151,00	151,20
7mm	172,90	173,50
8mm	194,80	195,70
9mm	216,70	217,90
10mm	244,10	245,20
11mm	266,00	267,40
12mm	287,90	289,60
13mm	309,80	311,80
14mm	331,80	334,00
15mm	353,70	356,20
16mm	375,60	378,40
18mm	419,40	422,80
20mm	488,20	490,30
25mm	597,80	601,40
30mm	707,30	712,40
40mm	926,40	934,50
50mm	1.145,50	1.156,60

Mikroporézní PE 60kg/m ³ 2000x1000mm - barevné		
tloušťka	Cena	
	1 - 9,99m ²	10 - 99,99m ²
1mm	43,60	34,80
2mm	67,60	54,10
3mm	91,70	73,30
4mm	115,70	92,60
5mm	139,80	111,80
6mm	163,90	131,10
7mm	187,90	150,30
8mm	212,00	169,60
9mm	236,00	188,80
10mm	265,60	212,50
11mm	289,60	231,70
12mm	313,70	251,00
13mm	337,80	270,20
14mm	361,80	289,50
15mm	385,90	308,70
16mm	409,90	328,00
18mm	458,10	366,40
20mm	531,20	424,90
25mm	651,50	521,20
30mm	771,80	617,40
40mm	1.012,40	809,90
50mm	1.252,90	1.002,40

Mikroporézní PE 100kg/m ³ 2000x1000mm - bílá + antracit		
tloušťka	Cena	
	1 - 9,99m ²	10 - 99,99m ²
1mm	56,40	52,00
2mm	93,20	86,10
3mm	130,10	120,10
4mm	167,00	154,10
5mm	203,80	188,10
6mm	240,70	222,20
7mm	277,60	256,20
8mm	314,40	290,20
9mm	351,30	324,30
10mm	393,70	363,40
11mm	430,50	397,40
12mm	467,40	431,40
13mm	504,30	465,50
14mm	541,10	499,40
15mm	578,00	533,50
16mm	614,90	567,60
18mm	688,60	635,60
20mm	787,30	726,80
25mm	971,60	896,90
30mm	1.156,00	1.067,10
40mm	1.524,60	1.407,30
50mm	1.893,30	1.747,60

Mikroporézní PE 100kg/m ³ 2000x1000mm - barevné		
tloušťka	Cena	
	1 - 9,99m ²	10 - 99,99m ²
1mm	60,00	55,40
2mm	100,50	92,70
3mm	140,90	130,10
4mm	181,40	167,50
5mm	221,90	204,80
6mm	262,40	242,20
7mm	302,90	279,60
8mm	343,30	316,90
9mm	383,80	354,30
10mm	429,80	396,70
11mm	470,30	434,10
12mm	510,80	471,50
13mm	551,20	508,80
14mm	591,70	546,20
15mm	632,20	583,60
16mm	672,70	620,90
18mm	753,60	695,70
20mm	859,60	793,50
25mm	1.062,00	980,30
30mm	1.264,40	1.167,10
40mm	1.669,20	1.540,80
50mm	2.074,00	1.914,50

Mikroporézní PE 120kg/m ³ 1890x930mm - bílá + antracit		
tloušťka	Cena	
	1 - 9,99m ²	10 - 99,99m ²
1mm	65,40	60,30
2mm	103,90	95,90
3mm	157,10	145,00
4mm	202,90	187,30
5mm	248,80	229,70
6mm	294,70	272,00
7mm	340,50	314,30
8mm	386,40	356,70
9mm	432,30	399,00
10mm	483,60	446,40
11mm	529,50	488,70
12mm	575,30	531,10
13mm	621,20	573,40
14mm	667,10	615,70
15mm	712,90	658,10
16mm	758,80	700,40
18mm	850,50	785,10
20mm	967,20	892,80
25mm	1.196,50	1.104,50
30mm	1.425,80	1.316,20
40mm	1.884,50	1.739,50
50mm	2.343,10	2.162,80

Mikroporézní PE 120kg/m ³ 1890x930mm - barevné		
tloušťka	Cena	
	1 - 9,99m ²	10 - 99,99m ²
1mm	69,90	64,50
2mm	112,20	103,60
3mm	170,60	157,50
4mm	220,90	203,90
5mm	271,30	250,40
6mm	321,60	296,90
7mm	372,00	343,40
8mm	422,40	389,90
9mm	472,70	436,40
10mm	528,60	487,90
11mm	578,90	534,40
12mm	629,30	580,90
13mm	679,70	627,40
14mm	730,00	673,90
15mm	780,40	720,30
16mm	830,70	766,80
18mm	931,40	859,80
20mm	1.057,20	975,80
25mm	1.309,00	1.208,30
30mm	1.560,70	1.440,70
40mm	2.064,30	1.905,50
50mm	2.567,90	2.370,40

Mikroporézní PE 200kg/m ³ 1650x830mm - bílá + antracit		
tloušťka	Cena	
	1 - 9,99m ²	10 - 99,99m ²
1mm	85,10	78,50
2mm	150,60	139,00
3mm	216,20	199,60
4mm	281,80	260,10
5mm	347,30	320,60
6mm	412,90	381,10
7mm	478,50	441,70
8mm	544,00	502,20
9mm	609,60	562,70
10mm	680,60	628,30
11mm	746,20	688,80
12mm	811,80	749,30
13mm	877,30	809,90
14mm	942,90	870,40
15mm	1.008,50	930,90
16mm	1.074,00	991,40
18mm	1.205,20	1.112,50
20mm	1.361,30	1.256,60
25mm	1.689,10	1.559,20
30mm	2.016,90	1.861,80
40mm	2.672,60	2.467,00
50mm	3.328,20	3.072,20

Mikroporézní PE 200kg/m ³ 1650x830mm - barevné		
tloušťka	Cena	
	1 - 9,99m ²	10 - 99,99m ²
1mm	91,50	84,50
2mm	163,50	150,90
3mm	235,50	217,40
4mm	307,50	283,80
5mm	379,50	350,30
6mm	451,50	416,70
7mm	523,50	483,20
8mm	595,50	549,70
9mm	667,50	616,10
10mm	745,00	687,70
11mm	817,00	754,10
12mm	889,00	820,60
13mm	960,90	887,00
14mm	1.032,90	953,50
15mm	1.104,90	1.019,90
16mm	1.176,90	1.086,40
18mm	1.320,90	1.219,30
20mm	1.489,90	1.375,30
25mm	1.849,90	1.707,360
30mm	2.209,90	2.039,90
40mm	2.929,80	2.704,50
50mm	3.649,80	3.369,00

Mikroporézní deska EVA

Mikroporézní deska, uzavřené póry s výbornou pružností. **Barvy:** černá, žlutá, červená, modrá, zelená, světle šedá.

Odolnost: Vysoce odolná vůči povětrnostním vlivům a UV záření.

Mikroporézní EVA 33kg/m ³ 2000x1000mm - bílá + antracit		
tloušťka	Cena	
	1 - 9,99m ²	10 - 99,99m ²
1mm	32,50	30,00
2mm	45,50	42,00
3mm	58,40	54,00
4mm	71,40	65,90
5mm	84,40	77,90
6mm	97,40	89,90
7mm	110,40	101,90
8mm	123,40	113,90
9mm	136,30	125,90
10mm	154,80	142,90
11mm	167,80	154,90
12mm	180,80	166,90
13mm	193,80	178,90
14mm	206,80	190,90
15mm	219,70	202,80
16mm	232,70	214,80
18mm	258,70	238,80
20mm	309,70	285,80
25mm	374,60	345,80
30mm	439,50	405,70
40mm	569,30	525,50
50mm	699,10	654,40

Mikroporézní EVA 33kg/m ³ 2000x1000mm - barevné		
tloušťka	Cena	
	1 - 9,99m ²	10 - 99,99m ²
1mm	33,70	31,10
2mm	48,00	44,30
3mm	62,20	57,40
4mm	76,50	70,60
5mm	90,70	83,70
6mm	104,90	96,90
7mm	119,20	110,00
8mm	133,40	123,20
9mm	147,70	136,30
10mm	167,40	154,50
11mm	181,60	167,70
12mm	195,90	180,80
13mm	210,10	193,90
14mm	224,40	207,10
15mm	238,60	220,20
16mm	252,80	233,40
18mm	281,30	259,70
20mm	334,80	309,00
25mm	406,00	374,80
30mm	477,20	440,50
40mm	619,60	570,90
50mm	762,00	703,40

Mikroporézní EVA 45kg/m ³ 2000x1000mm - bílá + antracit		
tloušťka	Cena	
	1 - 9,99m ²	10 - 99,99m ²
1mm	36,20	33,40
2mm	52,80	48,80
3mm	69,50	64,20
4mm	86,20	79,60
5mm	102,90	95,00
6mm	119,50	110,40
7mm	136,20	125,70
8mm	152,90	141,10
9mm	169,60	156,50
10mm	191,70	177,00
11mm	208,40	192,40
12mm	225,10	207,80
13mm	241,80	223,20
14mm	258,40	238,60
15mm	275,10	254,00
16mm	291,80	269,30
18mm	325,10	300,10
20mm	383,50	354,00
25mm	466,90	431,00
30mm	550,20	507,90
40mm	717,00	661,80
50mm	883,70	815,80

Mikroporézní EVA 45kg/m ³ 2000x1000mm - barevné		
tloušťka	Cena	
	1 - 9,99m ²	10 - 99,99m ²
1mm	37,80	34,90
2mm	56,10	51,80
3mm	74,40	68,70
4mm	92,70	85,60
5mm	111,00	102,50
6mm	129,30	119,30
7mm	147,60	136,20
8mm	165,90	153,10
9mm	184,20	170,00
10mm	208,00	192,00
11mm	226,30	208,90
12mm	244,60	225,80
13mm	262,90	242,70
14mm	281,20	259,60
15mm	299,50	276,50
16mm	317,80	293,30
18mm	354,40	327,10
20mm	416,00	384,00
25mm	507,50	468,40
30mm	599,00	552,90
40mm	782,00	721,80
50mm	965,00	890,70

Mikroporézní EVA 60kg/m ³ 2000x1000mm - bílá + antracit		
tloušťka	Cena	
	1 - 9,99m ²	10 - 99,99m ²
1mm	43,60	40,20
2mm	67,60	62,40
3mm	91,70	84,60
4mm	115,70	106,80
5mm	139,80	129,00
6mm	163,90	151,20
7mm	187,90	173,50
8mm	212,00	195,70
9mm	236,00	217,90
10mm	265,60	245,20
11mm	289,60	267,40
12mm	313,70	289,60
13mm	337,80	311,80
14mm	361,80	334,00
15mm	385,90	356,20
16mm	409,90	378,40
18mm	458,10	422,80
20mm	531,20	490,30
25mm	651,50	601,40
30mm	771,80	712,40
40mm	1.012,40	934,50
50mm	1.252,90	1.156,60

Mikroporézní EVA 60kg/m ³ 2000x1000mm - barevné		
tloušťka	Cena	
	1 - 9,99m ²	10 - 99,99m ²
1mm	45,90	42,40
2mm	72,30	66,80
3mm	98,80	91,20
4mm	125,20	115,60
5mm	151,60	139,90
6mm	178,00	164,30
7mm	204,50	188,70
8mm	230,90	213,10
9mm	257,30	237,50
10mm	289,20	267,00
11mm	315,60	291,40
12mm	342,10	315,70
13mm	368,50	340,10
14mm	394,90	364,50
15mm	421,30	388,90
16mm	447,70	413,30
18mm	500,60	462,10
20mm	578,40	533,90
25mm	710,50	655,90
30mm	842,70	777,80
40mm	1.106,90	1.021,70
50mm	1.371,10	1.265,60

Mikroporézní EVA 100kg/m ³ 2000x1000mm - bílá + antracit		
tloušťka	Cena	
	1 - 9,99m ²	10 - 99,99m ²
1mm	58,70	54,20
2mm	98,00	90,40
3mm	137,20	126,60
4mm	176,40	162,90
5mm	215,70	199,10
6mm	254,90	235,30
7mm	294,10	271,50
8mm	333,40	307,70
9mm	372,60	343,90
10mm	417,30	385,20
11mm	456,60	421,50
12mm	495,80	457,70
13mm	535,00	493,90
14mm	574,30	530,10
15mm	613,50	566,30
16mm	652,80	602,50
18mm	731,20	675,00
20mm	834,70	770,50
25mm	1.030,90	951,60
30mm	1.227,00	1.132,60
40mm	1.619,40	1.494,80
50mm	2.011,70	1.857,00

Mikroporézní EVA 100kg/m ³ 2000x1000mm - barevné		
tloušťka	Cena	
	1 - 9,99m ²	10 - 99,99m ²
1mm	62,60	57,80
2mm	105,70	97,50
3mm	148,80	137,30
4mm	191,90	177,10
5mm	234,90	216,90
6mm	278,00	256,60
7mm	321,10	296,40
8mm	364,20	336,20
9mm	407,30	376,00
10mm	455,90	420,80
11mm	499,00	460,60
12mm	542,10	500,40
13mm	585,10	540,10
14mm	628,20	579,90
15mm	671,30	619,70
16mm	714,40	659,90
18mm	800,60	739,00
20mm	911,80	841,60
25mm	1.127,20	1.040,50
30mm	1.342,60	1.239,40
40mm	1.773,50	1.637,10
50mm	2.204,40	2.034,80

Mikroporézní EVA 120kg/m ³ 1890x930mm - bílá + antracit		
tloušťka	Cena	
	1 - 9,99m ²	10 - 99,99m ²
1mm	67,40	62,20
2mm	115,30	106,40
3mm	163,10	150,60
4mm	211,00	194,80
5mm	258,90	239,00
6mm	306,80	283,20
7mm	354,70	327,40
8mm	402,60	371,60
9mm	450,40	415,80
10mm	503,80	465,10
11mm	551,70	509,30
12mm	599,60	553,50
13mm	647,50	597,70
14mm	696,30	641,90
15mm	743,20	686,10
16mm	791,10	730,20
18mm	886,90	818,60
20mm	1.007,60	930,10
25mm	1.247,00	1.151,10
30mm	1.486,40	1.372,10
40mm	1.965,30	1.814,10
50mm	2.444,10	2.256,10

Mikroporézní EVA 120kg/m ³ 1890x930mm - barevné		
tloušťka	Cena	
	1 - 9,99m ²	10 - 99,99m ²
1mm	72,10	66,50
2mm	124,70	115,10
3mm	177,30	163,60
4mm	229,80	212,20
5mm	282,40	260,70
6mm	335,00	309,30
7mm	387,60	357,80
8mm	440,20	406,30
9mm	492,80	454,90
10mm	550,90	508,50
11mm	603,50	557,00
12mm	656,00	605,60
13mm	708,60	654,10
14mm	761,20	702,70
15mm	813,80	751,20
16mm	866,40	799,80
18mm	971,60	896,80
20mm	1.101,70	1.017,00
25mm	1.364,70	1.259,70
30mm	1.627,60	1.502,40
40mm	2.153,50	1.987,80
50mm	2.679,40	2.473,30

Mikroporézní EVA 140kg/m ³ 1800x880mm - bílá + antracit		
tloušťka	Cena	
	1 - 9,99m ²	10 - 99,99m ²
1mm	73,80	68,10
2mm	128,20	118,30
3mm	182,50	168,40
4mm	236,80	218,60
5mm	291,10	268,70
6mm	345,50	318,90
7mm	399,80	369,00
8mm	454,10	419,20
9mm	508,40	469,30
10mm	568,30	524,50
11mm	622,60	574,70
12mm	676,90	624,80
13mm	731,20	675,00
14mm	785,60	725,10
15mm	839,90	775,30
16mm	894,20	825,40
18mm	1.002,90	925,70
20mm	1.136,50	1.049,10
25mm	1.408,10	1.299,80
30mm	1.679,80	1.550,60
40mm	2.223,00	2.052,00
50mm	2.766,30	2.553,50

Mikroporézní EVA 140kg/m ³ 1800x880mm - barevné		
tloušťka	Cena	
	1 - 9,99m ²	10 - 99,99m ²
1mm	79,20	73,10
2mm	138,80	128,10
3mm	198,50	183,20
4mm	258,10	238,30
5mm	317,80	293,30
6mm	377,40	348,40
7mm	437,10	403,50
8mm	496,80	458,50
9mm	556,40	513,60
10mm	621,60	573,80
11mm	681,20	628,80
12mm	740,90	683,90
13mm	800,50	739,00
14mm	860,20	794,00
15mm	919,80	849,10
16mm	979,50	904,20
18mm	1.098,80	1.014,30
20mm	1.243,10	1.147,50
25mm	1.541,40	1.422,80
30mm	1.839,70	1.698,20
40mm	2.436,30	2.248,80
50mm	3.032,80	2.799,50

Mikroporézní EVA 200kg/m ³ 1650x830mm - bílá + antracit		
tloušťka	Cena	
	1 - 9,99m ²	10 - 99,99m ²
1mm	88,90	82,00
2mm	158,30	146,10
3mm	227,60	210,10
4mm	297,00	274,20
5mm	366,40	338,20
6mm	435,80	402,20
7mm	505,10	466,30
8mm	574,50	530,30
9mm	643,90	594,40
10mm	718,80	663,50
11mm	788,20	727,50
12mm	857,50	791,60
13mm	926,90	855,60
14mm	996,30	919,70
15mm	1.065,70	983,70
16mm	1.135,00	1.047,70
18mm	1.273,80	1.175,80
20mm	1.437,60	1.327,00
25mm	1.784,40	1.647,20
30mm	2.131,30	1.967,40
40mm	2.825,10	2.607,80
50mm	3.518,90	3.248,20

Mikroporézní EVA 200kg/m ³ 1650x830mm - barevné		
tloušťka	Cena	
	1 - 9,99m ²	10 - 99,99m ²
1mm	95,70	88,30
2mm	171,90	158,70
3mm	248,10	229,00
4mm	324,30	299,30
5mm	400,50	369,70
6mm	476,70	440,00
7mm	552,90	510,30
8mm	629,10	580,70
9mm	705,30	651,00
10mm	786,90	726,40
11mm	863,10	796,70
12mm	939,30	867,10
13mm	1.015,50	937,40
14mm	1.091,70	1.007,70
15mm	1.167,90	1.078,10
16mm	1.244,10	1.148,40
18mm	1.396,50	1.289,10
20mm	1.573,90	1.452,80
25mm	1.954,90	1.804,50
30mm	2.335,80	2.156,20
40mm	3.097,80	2.859,50
50mm	3.859,70	3.562,80

Mikroporézní EVA 250kg/m ³ 1800x900mm - bílá + antracit		
tloušťka	Cena	
	1 - 9,99m ²	10 - 99,99m ²
1mm	105,60	97,40
2mm	191,60	176,90
3mm	277,70	256,30
4mm	363,70	335,70
5mm	449,80	415,20
6mm	535,80	494,60
7mm	621,90	574,00
8mm	707,90	653,40
9mm	794,00	732,90
10mm	885,50	817,40
11mm	971,60	896,80
12mm	1.057,60	976,30
13mm	1.143,70	1.055,70
14mm	1.229,70	1.135,10
15mm	1.315,80	1.214,50
16mm	1.401,80	1.294,00
18mm	1.573,90	1.452,80
20mm	1.771,00	1.634,80
25mm	2.201,30	2.031,90
30mm	2.631,50	2.429,10
40mm	3.492,00	3.223,40

Mikroporézní EVA 250kg/m ³ 1800x900mm - barevné		
tloušťka	Cena	
	1 - 9,99m ²	10 - 99,99m ²
1mm	114,00	105,30
2mm	208,60	192,50
3mm	303,10	279,80
4mm	397,60	367,00
5mm	492,20	454,30
6mm	586,70	541,60
7mm	681,20	628,80
8mm	775,80	716,10
9mm	870,30	803,30
10mm	970,30	895,70
11mm	1.064,80	982,90
12mm	1.159,40	1.070,20
13mm	1.253,90	1.157,50
14mm	1.348,40	1.244,70
15mm	1.443,00	1.332,00
16mm	1.537,50	1.419,20
18mm	1.726,60	1.593,80
20mm	1.940,60	1.791,40
25mm	2.413,30	2.227,70
30mm	2.885,90	2.664,00
40mm	3.831,30	3.536,60

Mikroporézní EVA 300kg/m ³ 1700x850mm - bílá + antracit		
tloušťka	Cena	
	1 - 9,99m ²	10 - 99,99m ²
1mm	105,00	96,90
2mm	190,50	175,80
3mm	276,00	254,80
4mm	361,50	333,70
5mm	447,00	412,60
6mm	532,50	491,50
7mm	618,00	570,40
8mm	703,50	649,40
9mm	789,00	728,30
10mm	880,00	812,30
11mm	965,50	891,20
12mm	1.051,00	970,10
13mm	1.136,50	1.049,00
14mm	1.222,00	1.128,00
15mm	1.307,50	1.206,90
16mm	1.393,00	1.285,80
18mm	1.564,00	1.443,70
20mm	1.760,00	1.624,60
25mm	2.187,40	2.019,20
30mm	2.614,90	2.413,80
40mm	3.469,90	3.203,00

Mikroporézní EVA 300kg/m ³ 1700x850mm - barevné		
tloušťka	Cena	
	1 - 9,99m ²	10 - 99,99m ²
1mm	113,40	104,70
2mm	207,30	191,40
3mm	301,20	278,00
4mm	395,10	364,70
5mm	489,00	451,40
6mm	582,90	538,10
7mm	676,80	624,70
8mm	770,70	711,40
9mm	864,60	798,10
10mm	964,00	889,80
11mm	1.057,90	976,50
12mm	1.151,80	1.063,20
13mm	1.245,70	1.149,90
14mm	1.339,60	1.236,50
15mm	1.433,50	1.323,20
16mm	1.527,40	1.409,90
18mm	1.715,20	1.583,30
20mm	1.928,00	1.779,70
25mm	2.397,50	2.213,10
30mm	2.867,00	2.646,40
40mm	3.806,00	3.513,20

DESKY PRYŽOVÉ

REGRANULÁT

Recyklovaná pryžová deska je vhodná do oblasti stavebního a běžného průmyslu pro tlumení hluku, zátěže a vibrací. Využívá se v průmyslových halách jako:

- podlaha k vyrovnání nerovností
- kabelový překlad
- podložka pod lisovací a odlévací formy
- podložka pod palety proti posunu
- podložka proti otěru mezi jednotlivými výrobky

Jednovrstvé desky z gumového granulátu se vyrábí z drcené pryže z pneu spojené polyuretanovým lepidlem. Vlastnosti materiálu se nemění ani v podmínkách s maximální námahou.

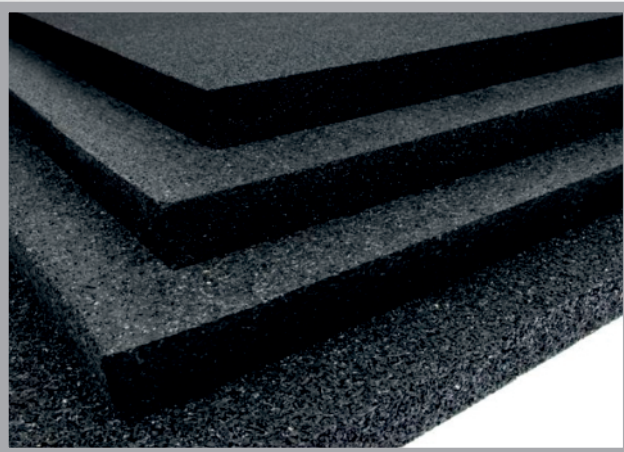

ADIREG - regranulát		Cena		
 tloušťka X rozměr 	0 - 12,49m ²	12,5 - 99,99m ²	100 -m ²	
tl. 3mm x 1.250x20.000mm	104,53	87,11	80,41	
tl. 4mm x 1.250x15.000mm	139,38	116,15	107,21	
tl. 5mm x 1.250x12.000mm	146,22	121,85	112,48	
tl. 6mm x 1.250x10.000mm	151,20	126,00	116,31	
tl. 8mm x 1.250x10.000mm	200,36	166,96	154,12	
tl. 10mm x 1.250x6.000mm	240,80	200,67	185,23	
tl. 12mm x 1.250x6.000mm	291,20	242,67	224,00	
tl. 15mm x 1.150x2.300mm	342,22	285,19	263,25	
tl. 20mm x 1.150x2.300mm	494,67	412,22	380,51	
tl. 25mm x 1.000x2.000mm	935,20	779,33	719,38	
tl. 30mm x 1.000x2.000mm	1.074,08	895,07	826,22	
tl. 40mm x 1.000x2.000mm	1.551,20	1.292,67	1.193,23	
tl. 50mm x 1.000x2.000mm	1.826,72	1.522,27	1.405,17	
tl. 60mm x 1.000x2.000mm	2.103,36	1.752,80	1.617,97	
tl. 64mm x 1.000x2.000mm	2.213,12	1.844,27	1.702,40	

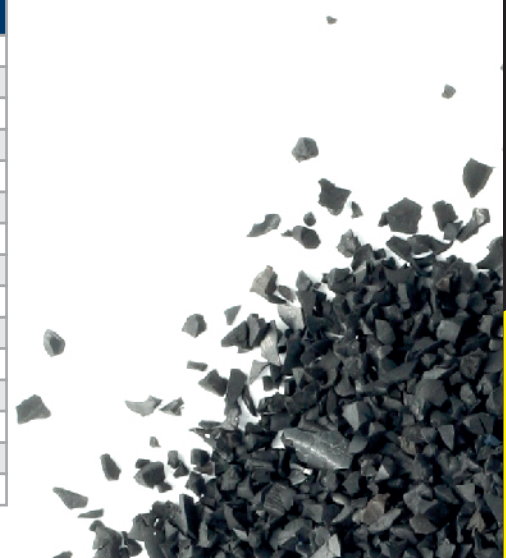

DESKY PRYŽOVÉ

REGRANULÁT



...těsně hned

Regranulátované PUZZLE desky.





Balení: Dřevěné palety 1000x1000mm. V případě potřeby Vám naceníme dopravu podle váhy zásilky a místa doručení.

Pro příplatkové barvy je minimální objednané množství 50m². Standardní barvy s příměsí 10% EPDM jsou skladem.

Standardní barvy:

 Červená RED 000 RAL 3016	 Zelená MAY GREEN 410 RAL 6017	 Šedá LIGHT GREY 380 RAL 7035
 Modrá SKY BLUE 180 RAL 5015	 Žlutá YELLOW 200 RAL 1012	





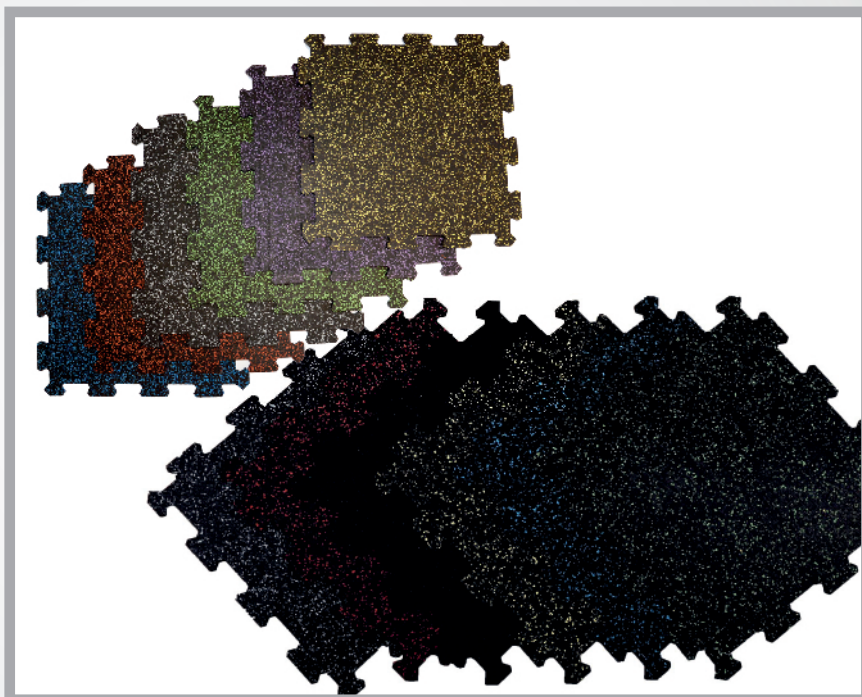
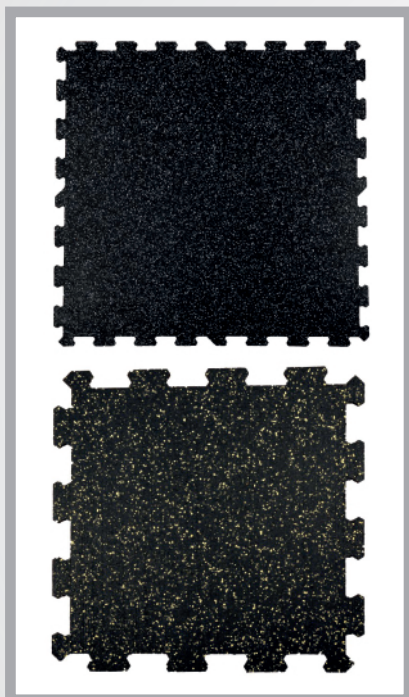



Příplatkové barvy:









 Oranžová ORANGE 550 RAL 2004	 Písk. žl. EARTH YELLOW 570 RAL 1011	 Tyrkys modrá TURQUOISE BLUE 540 RAL 5018
 Modrá TEAL 580 RAL 5024	 Tm. modrá CAPRI BLUE 150 RAL 5019	 Bílá PEARL 290 RAL 1013
 Růžová ROSE 750 RAL 3017	 Běžová BEIGE 210 RAL 1001	 Tm. modrá RAINBOW BLUE 590 RAL 5017
 Hnědá BROWN 280 RAL 8024	 Fialová PURPLE 340 RAL 4005	 Trávově zelená RAINBOW GREEN 560 RAL 6025
 Slate GREY RAL 7015	 EGG SHELL RAL 1015	 BLACK RAL 9004
 RESEDA GREEN RAL 6011	 Platina GREEN RAL 6000	 Signal GREEN RAL 6032
 BLUE GREY 100 RAL 5014		



DESKY PRYŽOVÉ

REGRANULÁT

Regranulát - PUZZLE BIG		Cena			
ČERNÁ	 rozměr 	0 - 9 ks	10 - 49 ks	50 - 99 ks	od 100 ks
ADIFLOOR PUZZLE ADI 1050	956x956x8mm	449,87	415,26	385,60	359,89
ADIFLOOR PUZZLE ADI 1050	956x956x10mm	518,93	479,02	444,80	415,15
ADIFLOOR PUZZLE ADI 1050	956x956x16mm	804,53	742,65	689,60	643,63
10% EPDM standard	 rozměr 	0 - 9 ks	10 - 49 ks	50 - 99 ks	od 100 ks
ADIFLOOR PUZZLE ADI 1050	956x956x8mm	567,47	523,82	486,40	453,97
ADIFLOOR PUZZLE ADI 1050	956x956x10mm	666,40	615,14	571,20	533,12
ADIFLOOR PUZZLE ADI 1050	956x956x16mm	1.039,73	959,75	891,20	831,79
20% EPDM standard	 rozměr 	0 - 9 ks	10 - 49 ks	50 - 99 ks	od 100 ks
ADIFLOOR PUZZLE ADI 1050	956x956x8mm	688,80	635,82	590,40	551,04
ADIFLOOR PUZZLE ADI 1050	956x956x10mm	817,60	754,71	700,80	654,08
ADIFLOOR PUZZLE ADI 1050	956x956x16mm	1.282,40	1.183,75	1.099,20	1.025,92
40% EPDM standard	 rozměr 	0 - 9 ks	10 - 49 ks	50 - 99 ks	od 100 ks
ADIFLOOR PUZZLE ADI 1050	956x956x8mm	938,93	866,71	804,80	751,15
ADIFLOOR PUZZLE ADI 1050	956x956x10mm	1.129,33	1.042,46	968,00	903,47
ADIFLOOR PUZZLE ADI 1050	956x956x16mm	1.780,80	1.643,82	1.526,40	1.424,64

Regranulát - PUZZLE SMALL		Cena			
ČERNÁ	 rozměr 	0 - 9 ks	10 - 49 ks	50 - 99 ks	od 100 ks
ADIFLOOR PUZZLE ADI 1050	478x478x8mm	117,60	108,55	100,80	94,08
ADIFLOOR PUZZLE ADI 1050	478x478x10mm	136,27	125,78	116,80	109,01
ADIFLOOR PUZZLE ADI 1050	478x478x16mm	207,20	191,26	177,60	165,76
10% EPDM standard	 rozměr 	0 - 9 ks	10 - 49 ks	50 - 99 ks	od 100 ks
ADIFLOOR PUZZLE ADI 1050	478x478x8mm	147,47	136,12	126,40	117,97
ADIFLOOR PUZZLE ADI 1050	478x478x10mm	171,73	158,52	147,20	137,39
ADIFLOOR PUZZLE ADI 1050	478x478x16mm	265,07	244,68	227,20	212,05
20% EPDM standard	 rozměr 	0 - 9 ks	10 - 49 ks	50 - 99 ks	od 100 ks
ADIFLOOR PUZZLE ADI 1050	478x478x8mm	179,20	165,42	153,60	143,36
ADIFLOOR PUZZLE ADI 1050	478x478x10mm	210,93	194,71	180,80	168,75
ADIFLOOR PUZZLE ADI 1050	478x478x16mm	326,67	301,54	280,00	261,33
40% EPDM standard	 rozměr 	0 - 9 ks	10 - 49 ks	50 - 99 ks	od 100 ks
ADIFLOOR PUZZLE ADI 1050	478x478x8mm	240,80	222,28	206,40	192,64
ADIFLOOR PUZZLE ADI 1050	478x478x10mm	287,47	265,35	246,40	229,97
ADIFLOOR PUZZLE ADI 1050	478x478x16mm	451,73	416,98	387,20	361,39

DESKY PRYŽOVÉ

REGRANULÁT



...těsně hned

Desky a komponenty na dětská hřiště

Uvedené rozměry jsou přibližné, desky podléhají smrštění cca 2%.

Všechny desky na dětská hřiště a elastické desky s rastrem 15mm lze vyrábět i v rozměrech 400x400mm, 500x1000mm, 600x600mm a 600x1200mm. Ceny za 1m² odpovídají cenám za rozměr 500x500mm.

Výrobky lze objednat také v barvě antracitově šedá a v barvě tmavě hnědá - za cenu zelené barvy.

Desky pryžové - regranulát					Výška pádu dle EN 1177*	Cena			
č.	Výrobek	rozměr	kód ADITEG	barva		0 - 9 m ²	10 - 49 m ²	50 - 99 m ²	od 100 m ²
1	Deska na dětská hřiště hladká tloušťka 20mm	500x500x20 hladká	ADI1-20-0300-00	● černá	0,60	634,00	592,00	555,00	523,00
			ADI1-20-0301-00	● červená		685,00	639,00	599,00	564,00
			ADI1-20-0302-00	● zelená		733,00	684,00	651,00	604,00
	Deska na dětská hřiště tloušťka 25mm a 30mm s vlisovanými otvory	500x500x25 rastr 15mm	ADI1-25-0300-15	● černá	0,90	634,00	592,00	555,00	523,00
			ADI1-25-0301-15	● červená		685,00	639,00	599,00	564,00
			ADI1-25-0302-15	● zelená		733,00	684,00	641,00	604,00
		1000x1000x25 rastr 15mm	ADI3-25-0300-15	● černá	0,90	634,00	592,00	555,00	523,00
			ADI3-25-0301-15	● červená		685,00	639,00	599,00	564,00
			ADI3-25-0302-15	● zelená		733,00	684,00	641,00	604,00
	500x500x30 hladká	ADI1-30-0300-00	ADI1-30-0300-00	● černá	0,90	886,00	827,00	775,00	730,00
			ADI1-30-0301-00	● červená		960,00	896,00	840,00	791,00
			ADI1-30-0302-00	● zelená		1.022,00	954,00	895,00	842,00
	1000x1000x30 hladká	ADI3-30-0300-00	ADI3-30-0300-00	● černá	0,90	886,00	827,00	775,00	730,00
			ADI3-30-0301-00	● červená		960,00	896,00	840,00	791,00
			ADI3-30-0302-00	● zelená		1.022,00	954,00	895,00	842,00
	500x500x30 rastr 15mm	ADI1-30-0300-15	ADI1-30-0300-15	● černá	1,10	784,00	731,00	686,00	645,00
			ADI1-30-0301-15	● červená		837,00	781,00	732,00	689,00
			ADI1-30-0302-15	● zelená		895,00	836,00	783,00	737,00
	1000x1000x30 rastr 15mm	ADI3-30-0300-15	ADI3-30-0300-15	● černá	1,10	784,00	731,00	686,00	645,00
			ADI3-30-0301-15	● červená		837,00	781,00	732,00	689,00
			ADI3-30-0302-15	● zelená		895,00	836,00	783,00	737,00
	500x500x30 rastr 18mm	ADI1-30-0300-18	ADI1-30-0300-18	● černá	1,00	681,00	636,00	596,00	561,00
			ADI1-30-0301-18	● červená		730,00	682,00	639,00	602,00
			ADI1-30-0302-18	● zelená		773,00	722,00	677,00	637,00
2	Deska na dětská hřiště tloušťka 40mm s vlisovanými otvory	500x500x40 rastr 15mm	ADI1-40-0300-15	● černá	1,30	1.070,00	999,00	937,00	882,00
			ADI1-40-0301-15	● červená		1.129,00	1.054,00	988,00	930,00
			ADI1-40-0302-15	● zelená		1.187,00	1.108,00	1.039,00	978,00
		1000x1000x40 rastr 15mm	ADI3-40-0300-15	● černá	1,30	1.070,00	999,00	937,00	882,00
			ADI3-40-0301-15	● červená		1.129,00	1.054,00	988,00	930,00
			ADI3-40-0302-15	● zelená		1.187,00	1.108,00	1.039,00	978,00
	500x500x40 rastr 28mm	ADI1-40-0300-28	ADI1-40-0300-28	● černá	1,30	846,00	790,00	740,00	697,00
			ADI1-40-0301-28	● červená		891,00	832,00	780,00	734,00
			ADI1-40-0302-28	● zelená		959,00	895,00	839,00	790,00
	1000x1000x40 rastr 28mm	ADI3-40-0300-28	ADI3-40-0300-28	● černá	1,30	846,00	790,00	740,00	697,00
			ADI3-40-0301-28	● červená		891,00	832,00	780,00	734,00
			ADI3-40-0302-28	● zelená		959,00	895,00	839,00	790,00

Desky pryžové - regranulát					Výška pádu dle EN 1177*	Cena					
č.	Výrobek	rozměr	kód ADITEG	barva		0 - 9 m ²	10 - 49 m ²	50 - 99 m ²	od 100 m ²		
3	Deska na dětská hřiště tloušťka 45mm s vlisovanými otvory	500x500x45 rastr 15mm	AD11-45-0300-15	● černá	1,50	1.187,00	1.108,00	1.039,00	978,00		
			AD11-45-0301-15	● červená		1.265,00	1.181,00	1.107,00	1.042,00		
			AD11-45-0302-15	● zelená		1.275,00	1.190,00	1.116,00	1.050,00		
		1000x1000x45 rastr 15mm	AD13-45-0300-15	● černá	1,50	1.187,00	1.108,00	1.039,00	978,00		
			AD13-45-0301-15	● červená		1.265,00	1.181,00	1.107,00	1.042,00		
			AD13-45-0302-15	● zelená		1.275,00	1.190,00	1.116,00	1.050,00		
		500x500x45 rastr BIG	AD11-45-0300-25 BIG	● černá	1,40	1.214,00	1.133,00	1.063,00	1.000,00		
			AD11-45-0301-25 BIG	● červená		1.316,00	1.228,00	1.151,00	1.083,00		
			AD11-45-0302-25 BIG	● zelená		1.390,00	1.297,00	1.216,00	1.144,00		
		500x500x45 rastr 28mm	AD11-45-0300-28	● černá	1,50	947,00	884,00	829,00	780,00		
			AD11-45-0301-28	● červená		987,00	922,00	864,00	813,00		
			AD11-45-0302-28	● zelená		1.037,00	968,00	907,00	854,00		
		1000x1000x45 rastr 28mm	AD13-45-0300-28	● černá	1,50	947,00	884,00	829,00	780,00		
			AD13-45-0301-28	● červená		987,00	922,00	864,00	813,00		
			AD13-45-0302-28	● zelená		1.037,00	968,00	907,00	854,00		
		4	Deska na dětská hřiště tloušťka 50mm s vlisovanými otvory	500x500x50 rastr 15mm	AD11-50-0300-15	● černá	1,40	1.246,00	1.163,00	1.090,00	1.026,00
					AD11-50-0301-15	● červená		1.304,00	1.217,00	1.141,00	1.074,00
					AD11-50-0302-15	● zelená		1.362,00	1.272,00	1.192,00	1.122,00
1000x1000x50 rastr 15mm	AD13-50-0300-15			● černá	1,40	1.246,00	1.163,00	1.090,00	1.026,00		
	AD13-50-0301-15			● červená		1.304,00	1.217,00	1.141,00	1.074,00		
	AD13-50-0302-15			● zelená		1.362,00	1.272,00	1.192,00	1.122,00		
500x500x50 rastr BIG	AD11-50-0300-25 BIG			● černá	1,50	1.327,00	1.239,00	1.161,00	1.039,00		
	AD11-50-0301-25 BIG			● červená		1.438,00	1.342,00	1.258,00	1.184,00		
	AD11-50-0302-25 BIG			● zelená		1.518,00	1.417,00	1.328,00	1.250,00		
500x500x50 rastr 28mm	AD11-50-0300-28			● černá	1,70	1.096,00	1.023,00	959,00	902,00		
	AD11-50-0301-28			● červená		1.201,00	1.121,00	1.051,00	989,00		
	AD11-50-0302-28			● zelená		1.270,00	1.186,00	1.111,00	1.046,00		
1000x1000x50 rastr 28mm	AD13-50-0300-28			● černá	1,70	1.109,00	1.035,00	971,00	914,00		
	AD13-50-0301-28			● červená		1.201,00	1.121,00	1.051,00	989,00		
	AD13-50-0302-28			● zelená		1.270,00	1.186,00	1.111,00	1.046,00		
5	Deska na dětská hřiště tloušťka 55mm, 65mm a 75mm s vlisovanými otvory			500x500x55 rastr 15mm	AD11-55-0300-15	● černá	1,50	1.436,00	1.341,00	1.257,00	1.183,00
					AD11-55-0301-15	● červená		1.557,00	1.453,00	1.362,00	1.282,00
					AD11-55-0302-15	● zelená		1.644,00	1.534,00	1.438,00	1.354,00
		500x500x55 rastr 28mm	AD11-55-0300-28	● černá	1,70	1.275,00	1.190,00	1.116,00	1.050,00		
			AD11-55-0301-28	● červená		1.382,00	1.290,00	1.209,00	1.138,00		
			AD11-55-0302-28	● zelená		1.460,00	1.362,00	1.277,00	1.202,00		
		500x500x65 rastr 28mm	AD11-65-0300-28	● černá	1,90	1.800,00	1.680,00	1.575,00	1.482,00		
			AD11-65-0301-28	● červená		1.923,00	1.795,00	1.683,00	1.584,00		
			AD11-65-0302-28	● zelená		1.936,00	1.807,00	1.694,00	1.594,00		
		500x500x65 rastr 50mm	AD11-65-7500-50	● černá	2,30	1.656,00	1.545,00	1.449,00	1.363,00		
			AD11-65-7501-50	● červená		1.732,00	1.617,00	1.516,00	1.426,00		
			AD11-65-7502-50	● zelená		1.848,00	1.724,00	1.617,00	1.522,00		
		1000x1000x65 rastr 50mm	AD13-65-7500-50	● černá	2,30	1.656,00	1.545,00	1.449,00	1.363,00		
			AD13-65-7501-50	● červená		1.732,00	1.616,00	1.515,00	1.426,00		
			AD13-65-7502-50	● zelená		1.848,00	1.725,00	1.617,00	1.522,00		
		500x500x75 rastr 50mm	AD11-75-7500-50	● černá	2,40	2.330,00	2.175,00	2.039,00	1.919,00		
			AD11-75-7501-50	● červená		2.391,00	2.232,00	2.092,00	1.969,00		
			AD11-75-7502-50	● zelená		2.582,00	2.410,00	2.259,00	2.126,00		

DESKY PRYŽOVÉ

REGRANULÁT



Desky pryžové - regranulát					Výška pádu dle EN 1177*	Cena			
č.	Výrobek	rozměr	kód ADITEG	barva		0 - 9 m ²	10 - 49 m ²	50 - 99 m ²	od 100 m ²
6	Deska na dětská hřiště tloušťka 80mm	500x500x80 rastr 15mm	ADI1-80-0300-15	● černá	1,70	2.254,00	2.103,00	1.972,00	1.856,00
			ADI1-80-0301-15	● červená		2.310,00	2.156,00	2.021,00	1.902,00
			ADI1-80-0302-15	● zelená		2.496,00	2.330,00	2.184,00	2.056,00
		500x500x80 rastr 28mm	ADI1-80-0300-28	● černá	1,90	2.077,00	1.939,00	1.818,00	1.711,00
			ADI1-80-0301-28	● červená		2.219,00	2.071,00	1.941,00	1.827,00
			ADI1-80-0302-28	● zelená		2.332,00	2.176,00	2.040,00	1.920,00
		500x500x80 rastr 50mm	ADI1-80-0300-50	● černá	2,40	1.846,00	1.723,00	1.615,00	1.520,00
			ADI1-80-0301-50	● červená		1.945,00	1.815,00	1.702,00	1.602,00
			ADI1-80-0302-50	● zelená		2.017,00	1.882,00	1.762,00	1.661,00
		1000x1000x80 rastr 50mm	ADI3-80-0300-50	● černá	2,40	1.846,00	1.723,00	1.615,00	1.520,00
			ADI3-80-0301-50	● červená		1.945,00	1.815,00	1.702,00	1.602,00
			ADI3-80-0302-50	● zelená		2.017,00	1.882,00	1.765,00	1.661,00
7	Deska na dětská hřiště tloušťka 90mm	500x500x90 rastr BIG	ADI1-90-0300-25 BIG	● černá	1,70	3.229,00	3.014,00	2.826,00	2.660,00
			ADI1-90-0301-25 BIG	● červená		3.424,00	3.196,00	2.993,00	2.820,00
			ADI1-90-0302-25 BIG	● zelená		3.580,00	3.341,00	3.132,00	2.948,00
		500x500x90 rastr 28mm	ADI1-90-0300-28	● černá	2,20	2.982,00	2.783,00	2.609,00	2.455,00
			ADI1-90-0301-28	● červená		3.162,00	2.951,00	2.767,00	2.604,00
			ADI1-90-0302-28	● zelená		3.309,00	3.088,00	2.895,00	2.725,00
8	Deska na dětská hřiště tloušťka 100mm	500x500x100 rastr 28mm	ADI1-00-0300-28	● černá	2,00	2.769,00	2.584,00	2.423,00	2.280,00
			ADI1-00-0301-28	● červená		2.919,00	2.725,00	2.554,00	2.404,00
			ADI1-00-0302-28	● zelená		3.031,00	2.829,00	2.652,00	2.496,00
		500x500x100 rastr 50mm	ADI1-00-0300-50	● černá	2,80	2.307,00	2.153,00	2.019,00	1.900,00
			ADI1-00-0301-50	● červená		2.433,00	2.271,00	2.129,00	2.003,00
			ADI1-00-0302-50	● zelená		2.524,00	2.355,00	2.208,00	2.078,00
		500x500x100 rastr 75mm	ADI1-00-0300-75	● černá	3,00	1.927,00	1.798,00	1.686,00	1.587,00
			ADI1-00-0301-75	● červená		1.989,00	1.856,00	1.740,00	1.638,00
			ADI1-00-0302-75	● zelená		2.063,00	1.925,00	1.805,00	1.699,00
9	Krajová deska tloušťka 30mm	500x500x30 hladká	ADI-K1-30-0300-00	● černá		1.265,00	1.181,00	1.107,00	1.042,00
			ADI-K1-30-0301-00	● červená		1.313,00	1.226,00	1.149,00	1.081,00
			ADI-K1-30-0302-00	● zelená		1.357,00	1.267,00	1.188,00	1.118,00
	Rohová deska tloušťka 30mm	500x500x30 hladká	ADI-R1-30-0300-00	● černá		1.226,00	1.144,00	1.073,00	1.010,00
			ADI-R1-30-0301-00	● červená		1.270,00	1.186,00	1.111,00	1.046,00
			ADI-R1-30-0302-00	● zelená		1.313,00	1.226,00	1.149,00	1.081,00
	Poloviční deska tloušťka 30mm	500x250x30 rastr 15mm	ADI1/2-30-0300-15	● černá		900,00	840,00	788,00	742,00
			ADI1/2-30-0301-15	● červená		963,00	899,00	842,00	793,00
			ADI1/2-30-0302-15	● zelená		1.030,00	962,00	901,00	848,00
10	Krajová deska tloušťka 40mm	500x500x40 hladká	ADI-K1-40-0300-00	● černá		1.543,00	1.440,00	1.350,00	1.270,00
			ADI-K1-40-0301-00	● červená		1.596,00	1.490,00	1.396,00	1.314,00
			ADI-K1-40-0302-00	● zelená		1.650,00	1.540,00	1.444,00	1.359,00
	Rohová deska tloušťka 40mm	500x250x40 hladká	ADI-R1-40-0300-00	● černá		1.455,00	1.358,00	1.273,00	1.198,00
			ADI-R1-40-0301-00	● červená		1.508,00	1.407,00	1.319,00	1.242,00
			ADI-R1-40-0302-00	● zelená		1.557,00	1.453,00	1.362,00	1.282,00
	Poloviční deska tloušťka 40mm	500x250x40 rastr 28mm	ADI1/2-40-0300-28	● černá		973,00	908,00	851,00	801,00
			ADI1/2-40-0301-28	● červená		1.025,00	957,00	897,00	844,00
			ADI1/2-40-0302-28	● zelená		1.103,00	1.029,00	965,00	908,00

Desky pryžové - regranulát					Cena			
č.	Výrobek	rozměr	kód ADITEG	barva	0 - 9 m ²	10 - 49 m ²	50 - 99 m ²	od 100 m ²
11	Krajová deska tloušťka 45mm	500x500x45 hladká	ADI-K1-45-0300-00	● černá	1.791,00	1.671,00	1.567,00	1.475,00
			ADI-K1-45-0301-00	● červená	1.854,00	1.731,00	1.622,00	1.527,00
			ADI-K1-45-0302-00	● zelená	1.913,00	1.785,00	1.673,00	1.575,00
	Rohová deska tloušťka 45mm	500x500x45 hladká	ADI-R1-45-0300-00	● černá	1.709,00	1.595,00	1.495,00	1.407,00
			ADI-R1-45-0301-00	● červená	1.765,00	1.647,00	1.544,00	1.453,00
			ADI-R1-45-0302-00	● zelená	1.823,00	1.701,00	1.595,00	1.501,00
	Poloviční deska tloušťka 45mm	500x250x45 rastr 28mm	ADI1/2-45-0300-28	● černá	1.090,00	1.017,00	954,00	898,00
			ADI1/2-45-0301-28	● červená	1.137,00	1.061,00	995,00	936,00
			ADI1/2-45-0302-28	● zelená	1.191,00	1.112,00	1.042,00	981,00
12	Krajová deska tloušťka 50mm	500x500x50 hladká	ADI-K1-50-0300-00	● černá	1.874,00	1.749,00	1.639,00	1.543,00
			ADI-K1-50-0301-00	● červená	1.936,00	1.807,00	1.694,00	1.594,00
			ADI-K1-50-0302-00	● zelená	1.999,00	1.866,00	1.750,00	1.647,00
	Rohová deska tloušťka 50mm	500x500x50 hladká	ADI-R1-50-0300-00	● černá	1.709,00	1.595,00	1.495,00	1.407,00
			ADI-R1-50-0301-00	● červená	1.766,00	1.648,00	1.545,00	1.454,00
			ADI-R1-50-0302-00	● zelená	1.824,00	1.703,00	1.596,00	1.502,00
	Poloviční deska tloušťka 50mm	500x250x50 rastr 28mm	ADI1/2-50-0300-28	● černá	1.277,00	1.192,00	1.117,00	1.051,00
			ADI1/2-50-0301-28	● červená	1.380,00	1.288,00	1.208,00	1.137,00
			ADI1/2-50-0302-28	● zelená	1.461,00	1.364,00	1.278,00	1.203,00
13	Krajová deska tloušťka 55mm	500x500x55 hladká	ADI-K1-55-0300-00	● černá	2.082,00	1.944,00	1.822,00	1.715,00
			ADI-K1-55-0301-00	● červená	2.155,00	2.011,00	1.886,00	1.775,00
			ADI-K1-55-0302-00	● zelená	2.224,00	2.076,00	1.946,00	1.831,00
	Rohová deska tloušťka 55mm	500x500x55 hladká	ADI-R1-55-0300-00	● černá	1.976,00	1.844,00	1.729,00	1.627,00
			ADI-R1-55-0301-00	● červená	2.044,00	1.907,00	1.788,00	1.683,00
			ADI-R1-55-0302-00	● zelená	2.112,00	1.972,00	1.848,00	1.740,00
	Poloviční deska tloušťka 55mm	500x250x55 rastr 28mm	ADI1/2-55-0300-28	● černá	1.466,00	1.368,00	1.283,00	1.207,00
			ADI1/2-55-0301-28	● červená	1.588,00	1.482,00	1.390,00	1.308,00
			ADI1/2-55-0302-28	● zelená	1.684,00	1.572,00	1.474,00	1.387,00
14	Krajová deska tloušťka 65mm	500x500x65 hladká	ADI-K1-65-0300-00	● černá	2.333,00	2.178,00	2.042,00	1.922,00
			ADI-K1-65-0301-00	● červená	2.121,00	1.980,00	1.856,00	1.747,00
			ADI-K1-65-0302-00	● zelená	2.195,00	2.049,00	1.921,00	1.808,00
	Rohová deska tloušťka 65mm	500x500x65 hladká	ADI-R1-65-0300-00	● černá	2.121,00	1.980,00	1.856,00	1.747,00
			ADI-R1-65-0301-00	● červená	2.195,00	2.049,00	1.921,00	1.808,00
			ADI-R1-65-0302-00	● zelená	2.225,00	2.077,00	1.947,00	1.832,00
	Poloviční deska tloušťka 65mm	500x250x65 rastr 28mm	ADI1/2-65-0300-28	● černá	2.071,00	1.933,00	1.812,00	1.705,00
			ADI1/2-65-0301-28	● červená	2.211,00	2.064,00	1.935,00	1.821,00
			ADI1/2-65-0302-28	● zelená	2.226,00	2.078,00	1.948,00	1.833,00
Rohová deska tloušťka 65mm	500x500x65 rastr 50mm	ADI1/2-65-0300-50	● černá	1.905,00	1.778,00	1.667,00	1.569,00	
		ADI1/2-65-0301-50	● červená	1.990,00	1.858,00	1.742,00	1.639,00	
		ADI1/2-65-0302-50	● zelená	2.125,00	1.984,00	1.860,00	1.750,00	
15	Krajová deska tloušťka 80mm	500x500x80 hladká	ADI-K1-80-0300-00	● černá	2.787,00	2.601,00	2.439,00	2.295,00
			ADI-K1-80-0301-00	● červená	2.886,00	2.693,00	2.525,00	2.376,00
			ADI-K1-80-0302-00	● zelená	2.982,00	2.783,00	2.609,00	2.455,00
	Rohová deska tloušťka 80mm	500x500x80 hladká	ADI-R1-80-0300-00	● černá	2.394,00	2.234,00	2.095,00	1.971,00
			ADI-R1-80-0301-00	● červená	2.477,00	2.312,00	2.167,00	2.040,00
			ADI-R1-80-0302-00	● zelená	2.544,00	2.375,00	2.226,00	2.095,00
	Poloviční deska tloušťka 80mm	500x250x80 rastr 50mm	ADI1/2-80-0300-50	● černá	1.998,00	1.865,00	1.748,00	1.646,00
			ADI1/2-80-0301-50	● červená	2.104,00	1.964,00	1.841,00	1.733,00
			ADI1/2-80-0302-50	● zelená	2.182,00	2.037,00	1.910,00	1.797,00

DESKY PRYŽOVÉ

REGRANULÁT



Desky pryžové - regranulát					Cena			
č.	Výrobek	rozměr	kód ADITEG	barva	0 - 9 m ²	10 - 49 m ²	50 - 99 m ²	od 100 m ²
16	Krajová deska tloušťka 90mm	500x500x90 hladká	ADI-K1-90-0300-00	● černá	3.017,00	2.816,00	2.640,00	2.484,00
			ADI-K1-90-0301-00	● červená	3.118,00	2.910,00	2.728,00	2.568,00
			ADI-K1-90-0302-00	● zelená	3.226,00	3.011,00	2.822,00	2.656,00
	Rohová deska tloušťka 90mm	500x500x90 hladká	ADI-R1-90-0300-00	● černá	2.496,00	2.330,00	2.184,00	2.056,00
			ADI-R1-90-0301-00	● červená	2.582,00	2.410,00	2.259,00	2.126,00
			ADI-R1-90-0302-00	● zelená	2.672,00	2.493,00	2.338,00	2.200,00
17	Krajová deska tloušťka 100mm	500x500x100 hladká	ADI-K1-00-0300-00	● černá	3.328,00	3.106,00	2.912,00	2.741,00
			ADI-K1-00-0301-00	● červená	3.445,00	3.215,00	3.014,00	2.837,00
			ADI-K1-00-0302-00	● zelená	3.562,00	3.324,00	3.116,00	2.933,00
	Rohová deska tloušťka 100mm	500x500x100 hladká	ADI-R1-00-0300-00	● černá	2.870,00	2.679,00	2.511,00	2.364,00
			ADI-R1-00-0301-00	● červená	2.973,00	2.774,00	2.601,00	2.448,00
			ADI-R1-00-0302-00	● zelená	3.071,00	2.866,00	2.687,00	2.529,00
	Poloviční deska tloušťka 100mm	500x250x100 rastr 75mm	ADI1/2-00-0300-75	● černá	2.216,00	2.068,00	1.939,00	1.825,00
			ADI1/2-00-0301-75	● červená	2.286,00	2.134,00	2.000,00	1.883,00
			ADI1/2-00-0302-75	● zelená	2.372,00	2.214,00	2.075,00	1.953,00
18	Nájezd pro desku na dětská hřiště	750x300x20	ADIN-20-0300-NA	● černá	250,00	233,00	219,00	206,00
			ADIN-20-0301-NA	● červená	262,00	245,00	229,00	216,00
			ADIN-20-0302-NA	● zelená	274,00	256,00	240,00	226,00
	750x300x25	ADIN-25-0300-NA	● černá	300,00	280,00	262,00	247,00	
		ADIN-25-0301-NA	● červená	315,00	294,00	275,00	259,00	
		ADIN-25-0302-NA	● zelená	329,00	307,00	288,00	271,00	
	750x300x30	ADIN-30-0300-NA	● černá	350,00	326,00	306,00	288,00	
		ADIN-30-0301-NA	● červená	367,00	342,00	321,00	302,00	
		ADIN-30-0302-NA	● zelená	384,00	358,00	336,00	316,00	
	750x300x35	ADIN-35-0300-NA	● černá	395,00	368,00	345,00	325,00	
		ADIN-35-0301-NA	● červená	414,00	386,00	362,00	341,00	
		ADIN-35-0302-NA	● zelená	433,00	404,00	379,00	357,00	
	750x300x40	ADIN-40-0300-NA	● černá	422,00	394,00	369,00	347,00	
		ADIN-40-0301-NA	● červená	445,00	415,00	389,00	366,00	
		ADIN-40-0302-NA	● zelená	466,00	435,00	408,00	384,00	
	750x300x45	ADIN-45-0300-NA	● černá	464,00	433,00	406,00	382,00	
		ADIN-45-0301-NA	● červená	489,00	457,00	428,00	406,00	
		ADIN-45-0302-NA	● zelená	514,00	480,00	450,00	423,00	
	750x300x50	ADIN-50-0300-NA	● černá	512,00	477,00	448,00	421,00	
		ADIN-50-0301-NA	● červená	539,00	503,00	472,00	444,00	
		ADIN-50-0302-NA	● zelená	566,00	528,00	495,00	466,00	
	750x300x65	ADIN-65-0300-NA	● černá	654,00	610,00	572,00	538,00	
		ADIN-65-0301-NA	● červená	689,00	643,00	603,00	568,00	
		ADIN-65-0302-NA	● zelená	723,00	675,00	633,00	595,00	

Desky pryžové - regranulát					Cena			
č.	Výrobek	 rozměr	kód ADITEG	barva	0 - 9 m ²	10 - 49 m ²	50 - 99 m ²	od 100 m ²
19	Nájezd rohový levý pro desku na dětská hřiště	750x300x20	ADIN-20-0300-RL	● černá	190,00	177,00	166,00	156,00
			ADIN-20-0301-RL	● červená	199,00	186,00	174,00	164,00
			ADIN-20-0302-RL	● zelená	208,00	194,00	182,00	171,00
		750x300x25	ADIN-25-0300-RL	● černá	225,00	210,00	197,00	185,00
			ADIN-25-0301-RL	● červená	236,00	220,00	206,00	194,00
			ADIN-25-0302-RL	● zelená	247,00	230,00	216,00	203,00
		750x300x30	ADIN-30-0300-RL	● černá	280,00	261,00	245,00	230,00
			ADIN-30-0301-RL	● červená	293,00	274,00	257,00	241,00
			ADIN-30-0302-RL	● zelená	307,00	286,00	268,00	253,00
		750x300x35	ADIN-35-0300-RL	● černá	300,00	280,00	262,00	247,00
			ADIN-35-0301-RL	● červená	314,00	293,00	275,00	259,00
			ADIN-35-0302-RL	● zelená	329,00	307,00	288,00	271,00
		750x300x40	ADIN-40-0300-RL	● černá	330,00	308,00	288,00	271,00
			ADIN-40-0301-RL	● červená	346,00	323,00	303,00	285,00
			ADIN-40-0302-RL	● zelená	362,00	338,00	316,00	298,00
		750x300x45	ADIN-45-0300-RL	● černá	369,00	345,00	323,00	304,00
			ADIN-45-0301-RL	● červená	388,00	362,00	339,00	319,00
			ADIN-45-0302-RL	● zelená	406,00	379,00	355,00	334,00
		750x300x50	ADIN-50-0300-RL	● černá	379,00	354,00	332,00	312,00
			ADIN-50-0301-RL	● červená	400,00	373,00	350,00	329,00
			ADIN-50-0302-RL	● zelená	419,00	391,00	367,00	345,00
750x300x65	ADIN-65-0300-RL	● černá	483,00	451,00	423,00	398,00		
	ADIN-65-0301-RL	● červená	510,00	476,00	446,00	420,00		
	ADIN-65-0302-RL	● zelená	534,00	499,00	467,00	440,00		
20	Nájezd rohový pravý pro desku na dětská hřiště	750x300x20	ADIN-20-0300-RP	● černá	190,00	177,00	166,00	156,00
			ADIN-20-0301-RP	● červená	199,00	186,00	174,00	164,00
			ADIN-20-0302-RP	● zelená	208,00	194,00	182,00	171,00
		750x300x25	ADIN-25-0300-RP	● černá	225,00	210,00	197,00	185,00
			ADIN-25-0301-RP	● červená	236,00	220,00	206,00	194,00
			ADIN-25-0302-RP	● zelená	247,00	230,00	216,00	203,00
		750x300x30	ADIN-30-0300-RP	● černá	280,00	261,00	245,00	230,00
			ADIN-30-0301-RP	● červená	293,00	274,00	257,00	241,00
			ADIN-30-0302-RP	● zelená	307,00	286,00	268,00	253,00
		750x300x35	ADIN-35-0300-RP	● černá	300,00	280,00	262,00	247,00
			ADIN-35-0301-RP	● červená	314,00	293,00	275,00	259,00
			ADIN-35-0302-RP	● zelená	329,00	307,00	288,00	271,00
		750x300x40	ADIN-40-0300-RP	● černá	330,00	308,00	288,00	271,00
			ADIN-40-0301-RP	● červená	346,00	323,00	303,00	285,00
			ADIN-40-0302-RP	● zelená	362,00	338,00	316,00	298,00
		750x300x45	ADIN-45-0300-RP	● černá	369,00	345,00	323,00	304,00
			ADIN-45-0301-RP	● červená	388,00	362,00	339,00	319,00
			ADIN-45-0302-RP	● zelená	406,00	379,00	355,00	334,00
		750x300x50	ADIN-50-0300-RP	● černá	379,00	354,00	332,00	312,00
			ADIN-50-0301-RP	● červená	400,00	373,00	350,00	329,00
			ADIN-50-0302-RP	● zelená	419,00	391,00	367,00	345,00
750x300x65	ADIN-65-0300-RP	● černá	483,00	451,00	423,00	398,00		
	ADIN-65-0301-RP	● červená	510,00	476,00	446,00	420,00		
	ADIN-65-0302-RP	● zelená	534,00	499,00	467,00	440,00		

DESKY PRYŽOVÉ

REGRANULÁT



Desky pryžové - regranulát					Cena					
č.	Výrobek	rozměr	kód ADITEG	barva	0 - 9 m ²	10 - 49 m ²	50 - 99 m ²	od 100 m ²		
21	Elastická deska hladká 500x500mm	500x500x20	ADI-E1-20-0300-00	● černá	589,00	550,00	515,00	485,00		
			ADI-E1-20-0301-00	● červená	647,00	604,00	567,00	533,00		
			ADI-E1-20-0302-00	● zelená	706,00	659,00	618,00	581,00		
		500x500x30	ADI-E1-30-0300-00	● černá	948,00	885,00	830,00	781,00		
			ADI-E1-30-0301-00	● červená	1.031,00	963,00	903,00	849,00		
			ADI-E1-30-0302-00	● zelená	1.065,00	994,00	932,00	877,00		
		500x500x40	ADI-E1-40-0300-00	● černá	1.182,00	1.103,00	1.034,00	973,00		
			ADI-E1-40-0301-00	● červená	1.270,00	1.186,00	1.111,00	1.046,00		
			ADI-E1-40-0302-00	● zelená	1.329,00	1.240,00	1.163,00	1.094,00		
		500x500x50	ADI-E1-50-0300-00	● černá	1.482,00	1.383,00	1.297,00	1.220,00		
			ADI-E1-50-0301-00	● červená	1.548,00	1.445,00	1.354,00	1.275,00		
			ADI-E1-50-0302-00	● zelená	1.611,00	1.504,00	1.410,00	1.327,00		
22	Elastická deska hladká 1000x1000mm	1000x1000x15	ADI-E3-15-0300-00	● černá	496,00	463,00	434,00	408,00		
			ADI-E3-15-0301-00	● červená	546,00	510,00	478,00	450,00		
			ADI-E3-15-0302-00	● zelená	595,00	555,00	520,00	490,00		
		1000x1000x20	ADI-E3-20-0300-00	● černá	589,00	550,00	515,00	485,00		
			ADI-E3-20-0301-00	● červená	647,00	604,00	567,00	533,00		
			ADI-E3-20-0302-00	● zelená	706,00	659,00	618,00	581,00		
		1000x1000x30	ADI-E3-30-0300-00	● černá	948,00	885,00	830,00	781,00		
			ADI-E3-30-0301-00	● červená	1.032,00	963,00	903,00	849,00		
			ADI-E3-30-0302-00	● zelená	1.065,00	994,00	932,00	877,00		
		1000x1000x40	ADI-E3-40-0300-00	● černá	1.182,00	1.103,00	1.034,00	973,00		
			ADI-E3-40-0301-00	● červená	1.270,00	1.186,00	1.111,00	1.046,00		
			ADI-E3-40-0302-00	● zelená	1.329,00	1.240,00	1.163,00	1.094,00		
		1000x1000x50	ADI-E3-50-0300-00	● černá	1.482,00	1.383,00	1.297,00	1.220,00		
			ADI-E3-50-0301-00	● červená	1.548,00	1.445,00	1.354,00	1.275,00		
			ADI-E3-50-0302-00	● zelená	1.611,00	1.504,00	1.410,00	1.327,00		
		23	Elastická deska s rastrem 500x500mm	500x500x30	ADI-E1-30-0300-15	● černá	900,00	840,00	788,00	742,00
					ADI-E1-30-0301-15	● červená	993,00	926,00	869,00	817,00
					ADI-E1-30-0302-15	● zelená	1.022,00	954,00	895,00	842,00
500x500x40	ADI-E1-40-0300-15			● černá	1.177,00	1.098,00	1.030,00	969,00		
	ADI-E1-40-0301-15			● červená	1.235,00	1.153,00	1.081,00	1.017,00		
	ADI-E1-40-0302-15			● zelená	1.300,00	1.213,00	1.138,00	1.071,00		
500x500x50	ADI-E1-50-0300-15			● černá	1.527,00	1.425,00	1.336,00	1.258,00		
	ADI-E1-50-0301-15			● červená	1.139,00	1.063,00	997,00	938,00		
	ADI-E1-50-0302-15			● zelená	1.687,00	1.574,00	1.476,00	1.389,00		
24	Elastická deska s rastrem 1000x1000mm	1000x1000x30	ADI-E3-30-0300-15	● černá	900,00	840,00	788,00	742,00		
			ADI-E3-30-0301-15	● červená	993,00	926,00	869,00	817,00		
			ADI-E3-30-0302-15	● zelená	1.022,00	954,00	895,00	842,00		
		1000x1000x40	ADI-E3-40-0300-15	● černá	1.177,00	1.098,00	1.030,00	969,00		
			ADI-E3-40-0301-15	● červená	1.235,00	1.153,00	1.081,00	1.017,00		
			ADI-E3-40-0302-15	● zelená	1.300,00	1.213,00	1.138,00	1.071,00		
		1000x1000x50	ADI-E3-50-0300-15	● černá	1.527,00	1.425,00	1.336,00	1.258,00		
			ADI-E3-50-0301-15	● červená	1.602,00	1.496,00	1.402,00	1.320,00		
			ADI-E3-50-0302-15	● zelená	1.687,00	1.574,00	1.476,00	1.389,00		

DESKY PRYŽOVÉ

Desky pryžové - regranulát					Cena					
č.	Výrobek	 rozměr	kód ADITEG	barva	0 - 9 m ²	10 - 49 m ²	50 - 99 m ²	od 100 m ²		
25	Zámková dlažba	200x165x43	ADI-K1-43-9900-00	● černá	1.329,00	1.241,00	1.163,00	1.095,00		
			ADI-K1-43-9901-00	● červená	1.416,00	1.322,00	1.239,00	1.166,00		
			ADI-K1-43-9902-00	● zelená	1.504,00	1.403,00	1.316,00	1.238,00		
26	Zámková deska	1120x1000x15	ADI-Z1-15-0300-00	● černá	651,00	608,00	570,00	536,00		
			ADI-Z1-15-0301-00	● červená	704,00	657,00	616,00	580,00		
			ADI-Z1-15-0302-00	● zelená	781,00	729,00	684,00	643,00		
	1120x1000x30	DI-Z1-30-0300-ADI-R	● černá	1.094,00	1.021,00	957,00	901,00			
		DI-Z1-30-0301-ADI-R	● červená	1.147,00	1.071,00	1.004,00	945,00			
		DI-Z1-30-0302-ADI-R	● zelená	1.199,00	1.119,00	1.049,00	987,00			
	1120x1000x43	DI-Z1-43-0300-ADI-R	● černá	1.356,00	1.266,00	1.187,00	1.117,00			
		DI-Z1-43-0301-ADI-R	● červená	1.408,00	1.314,00	1.232,00	1.160,00			
		DI-Z1-43-0302-ADI-R	● zelená	1.460,00	1.363,00	1.278,00	1.203,00			
27	Deska hladká	1000x1000x7	ADI-H3-07-0300-00	● černá	309,00	288,00	270,00	254,00		
			ADI-H3-07-0301-00	● červená	395,00	369,00	346,00	326,00		
			ADI-H3-07-0302-00	● zelená	457,00	427,00	400,00	377,00		
		1000x1000x11	ADI-H3-11-0300-00	● černá	457,00	427,00	400,00	377,00		
			ADI-H3-11-0301-00	● červená	556,00	519,00	487,00	458,00		
			ADI-H3-11-0302-00	● zelená	637,00	594,00	557,00	524,00		
		1000x1000x15	ADI-H3-15-0300-00	● černá	556,00	519,00	487,00	458,00		
			ADI-H3-15-0301-00	● červená	686,00	640,00	600,00	565,00		
			ADI-H3-15-0302-00	● zelená	804,00	750,00	703,00	662,00		
		1000x1000x23	ADI-H3-23-0300-00	● černá	847,00	791,00	741,00	698,00		
			ADI-H3-23-0301-00	● červená	1.044,00	975,00	914,00	860,00		
			ADI-H3-23-0302-00	● zelená	1.200,00	1.120,00	1.050,00	988,00		
		28	Antivibrační deska	2000x1000x23	ADI4-23-9700-00	● černá	751,00	701,00	657,00	619,00
				2000x1000x11	ADI4-11-9700-00	● černá	344,00	321,00	301,00	283,00
			Deska hladká Speciál	1200x1000x16	ADI-16-0100-00	● černá	1.032,00	963,00	903,00	849,00
1200x1000x20	ADI-20-0100-00			● černá	1.294,00	1.208,00	1.132,00	1.066,00		
Deska hladká Speciál formátovaná	1980x890x16		H4-16-9700-00-1100	● černá	1.791,00	1.671,00	1.567,00	1.475,00		
Stájová deska s kladívkovým vzorem, vulkanizovaná	1800x1200x17		ADI7-17-3300-HT	● černá	1.805,00	1.685,00	1.579,00	1.487,00		
	1000x500x55	ADI2-55-0400-VA	● černá	1.377,00	1.285,00	1.205,00	1.134,00			
		ADI2-55-0401-VA	● červená	1.435,00	1.339,00	1.256,00	1.182,00			
ADI3-40-0400-15		● černá	1.208,00	1.127,00	1.057,00	995,00				
29	Obrubník pískoviště	1000x300x150	ADI1-00-0300-00	● černá	1.413,00	1.319,00	1.236,00	1.164,00		
			ADI1-00-0301-00	● červená	1.473,00	1.375,00	1.289,00	1.213,00		
			ADI1-00-0302-00	● zelená	1.556,00	1.452,00	1.361,00	1.281,00		
Obrubník pískoviště	1500x300x150	ADI5-00-0300-00	● černá	2.313,00	2.159,00	2.024,00	1.905,00			
		ADI5-00-0301-00	● červená	2.428,00	2.267,00	2.125,00	2.000,00			
		ADI5-00-0302-00	● zelená	2.555,00	2.384,00	2.235,00	2.104,00			
Obrubník chodníkový	1000x250x50	ADI2-00-0300-00	● černá	552,00	515,00	483,00	455,00			
		ADI2-00-0301-00	● červená	592,00	553,00	518,00	488,00			
		ADI2-00-0302-00	● zelená	652,00	609,00	570,00	537,00			
30	Obrubník pískoviště	1150x300x150	ADI4-00-0300-00	● černá	1.413,00	1.319,00	1.236,00	1.164,00		
			ADI4-00-0301-00	● červená	1.473,00	1.375,00	1.289,00	1.213,00		
			ADI4-00-0302-00	● zelená	1.556,00	1.452,00	1.361,00	1.281,00		

DESKY PRYŽOVÉ

REGRANULÁT



Desky pryžové - regranulát					Cena			
č.	Výrobek	rozměr	kód ADITEG	barva	0 - 9 m ²	10 - 49 m ²	50 - 99 m ²	od 100 m ²
31	Kryt obručníku	1000x1000x100	ADI7-00-0300-00	● černá	328,00	306,00	287,00	270,00
			ADI7-00-0301-00	● červená	360,00	336,00	315,00	296,00
			ADI7-00-0302-00	● zelená	388,00	362,00	339,00	319,00
26	Palisáda	H=400, Ø=250	ADI1-40-9900-00	● černá	642,00	599,00	562,00	529,00
			ADI1-40-9901-00	● červená	691,00	645,00	605,00	569,00
			ADI1-40-9902-00	● zelená	728,00	680,00	637,00	600,00
		H=600, Ø=250	ADI2-60-9900-00	● černá	920,00	858,00	805,00	757,00
			ADI2-60-9901-00	● červená	967,00	902,00	846,00	796,00
			ADI2-60-9902-00	● zelená	1.019,00	951,00	891,00	839,00
		H=800, Ø=250	ADI3-80-9900-00	● černá	1.231,00	1.149,00	1.077,00	1.014,00
			ADI3-80-9901-00	● červená	1.297,00	1.211,00	1.135,00	1.069,00
			ADI3-80-9902-00	● zelená	1.366,00	1.275,00	1.195,00	1.125,00
	H=1000, Ø=250	ADI4-00-9900-00	● černá	1.541,00	1.438,00	1.348,00	1.269,00	
		ADI4-00-9901-00	● červená	1.622,00	1.514,00	1.419,00	1.336,00	
		ADI4-00-9902-00	● zelená	1.706,00	1.592,00	1.493,00	1.405,00	
	Kostka	300x300x300	ADI1-30-9901-00	● červená	1.513,00	1.412,00	1.324,00	1.246,00
	Kryt obručníku	1000x400x150	ADI3-00-0301-00	● červená	1.185,00	1.106,00	1.037,00	976,00
33	Příplatek za EPDM pro všechny desky na dětská hřiště a elastické desky	všechny tloušťky	černá 4021		983,00	918,00	860,00	810,00
			červená 4062 - RAL 3016		1.035,00	966,00	906,00	853,00
			zelená 4067 - RAL 6021		1.081,00	1.009,00	946,00	890,00
			RAL 5015, RAL 1014, RAL 1002, RAL 7038, RAL 7037, RAL 7011, RAL 8025, RAL 5012, RAL 1015		1.127,00	1.052,00	986,00	928,00
			RAL 1012, RAL 6017		1.264,00	1.180,00	1.106,00	1.041,00
			RAL 6005, RAL 5010, RAL 4003, RAL 4005, RAL 2008, RAL 3017		1.403,00	1.309,00	1.227,00	1.155,00
			mix		1.196,00	1.116,00	1.046,00	985,00
			mix S		688,00	642,00	602,00	567,00
34	Deska s trávou	500x500x25	ADI1-25-5610-15		1.247,00	1.164,00	1.091,00	1.027,00
		500x500x30	ADI1-30-5610-15		1.406,00	1.312,00	1.230,00	1.158,00
35	Deska s parketovým vzorem	500x500x25	ADI1-25-0300-15	● černá	642,00	599,00	561,00	528,00
			ADI1-25-0301-15	● červená	694,00	648,00	607,00	572,00
			ADI-25-0302-15	● zelená	743,00	693,00	650,00	612,00

Položky, na které se nevztahují zákaznické ceny				Cena				
č.	Vrtání a kolíky	název	množství	kód ADITEG	0 - 9 ks	10 - 49 ks	50 - 99 ks	od 100 ks
36	Vrtání je možné provádět od tloušťky desky min. 25mm	Vrtání ze 2 stran	platné pro 1ks desky	ADI9990	zdarma	zdarma	zdarma	zdarma
		Vrtání ze 4 stran	platné pro 1ks desky	ADI9991	zdarma	zdarma	zdarma	zdarma
		Spojovací kolík	pro 1ks desky jsou potřebné 4 kolíky	ADI8888	2,80	2,60	2,40	2,30
		Spojovací kolík	pro 1ks desky 4 jsou potřebné 4 kolíky	ADI9999	2,80	2,60	2,40	2,30
37	Spojovací prvky pro kryt obrubníku a obrubník pískoviště	Spojovací kolík pro kryt obrubníku	pro 1ks desky jsou potřebné 3 kolíky	ADI3-SPOJ-0080	4,10	3,80	3,60	3,30
		Spojovací trubka pro obrubník pískoviště OB4	délka 280mm	ADI4-SPOJ-0280	108,00	101,00	95,00	89,00
		Spojovací trubka pro obrubník pískoviště OB4	délka 600mm	ADI4-SPOJ-0600	112,00	105,00	98,00	93,00
		Spojovací trubka pro obrubník pískoviště OB4	délka 750mm	ADI4-SPOJ-0750	118,00	110,00	104,00	97,00

Vratné obaly			Cena
Palety	rozměry	kód ADITEG	1 ks
Paleta dřevěná	1200x800	ADI0301	265,00
Paleta dřevěná	1000x1000	ADI0308	265,00
Paleta dřevěná	1200x1100	ADI0311	298,00
Paleta dřevěná	2000x1000	ADI0305	415,00

1/ Deska na dětská hřiště hladká 20mm a s vlisovanými otvory 25mm a 30mm



2/ Deska na dětská hřiště 40mm s vlisovanými otvory

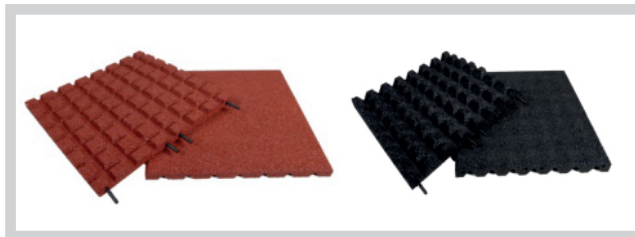

3/ Deska na dětská hřiště 45mm s vlisovanými otvory



4/ Deska na dětská hřiště 50mm s vlisovanými otvory

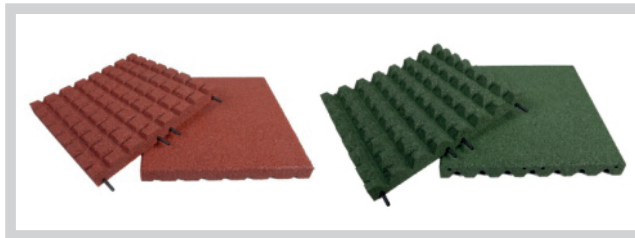

DESKY PRYŽOVÉ

REGRANULÁT



...těsní hned

5/ Deska na dětská hřiště 55mm, 65mm a 75mm s vlisovanými otvory

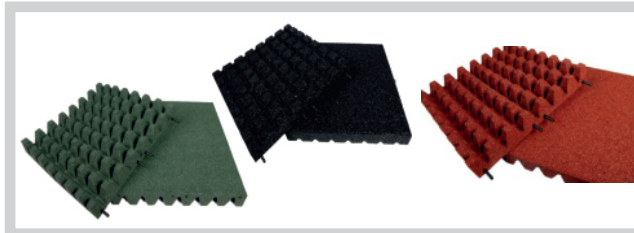

6/ Deska na dětská hřiště 80mm

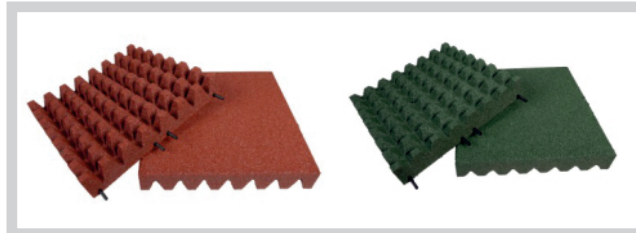

7/ Deska na dětská hřiště 90mm



8/ Deska na dětská hřiště 100mm

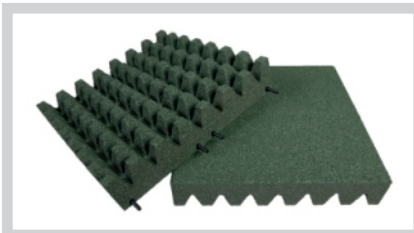

9/ Krajová, rohová a poloviční deska 30mm



10/ Krajová, rohová a poloviční deska 40mm



11/ Krajová, rohová a poloviční deska 45mm

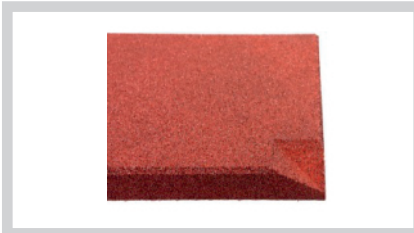

12/ Krajová, rohová a poloviční deska 50mm



13/ Krajová, rohová a poloviční deska 55mm



14/ Krajová, rohová a poloviční deska 65mm



15/ Krajová, rohová a poloviční deska 80mm



16/ Krajová, rohová a poloviční deska 90mm



17/ Krajová, rohová a poloviční deska 100mm

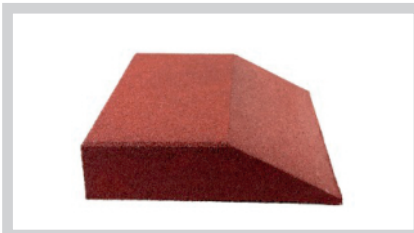

18/ Nájezd pro desku na dětská hřiště



19/ Nájezd rohový levý pro desku na dětská hřiště



20/ Nájezd rohový pravý pro desku na dětská hřiště



21/ Elastická deska hladká 500x500mm

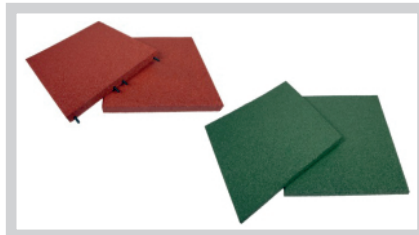

22/ Elastická deska hladká 1000x1000mm



23/ Elastická deska s rastrem 500x500mm



24/ Elastická deska s rastrem 1000x1000mm



25/ Zámková dlažba



26/ Zámková deska



27/ Deska hladká



28/ Antivibrační deska, deska Speciál, stájové desky

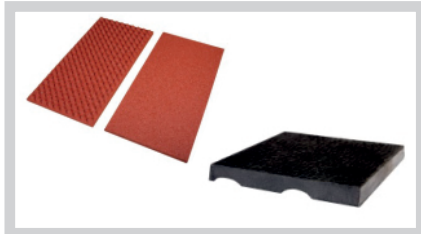

29/ Obrubník na pískoviště a chodníkový

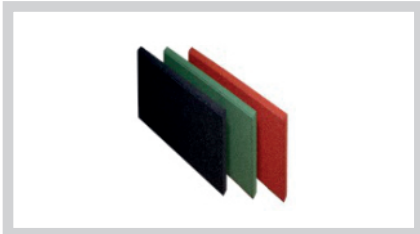

30/ Obrubník pískoviště



31/ Kryt obrubníku chodníkového



32/ Palisáda



33/ Příplatek za EPDM pro všechny desky

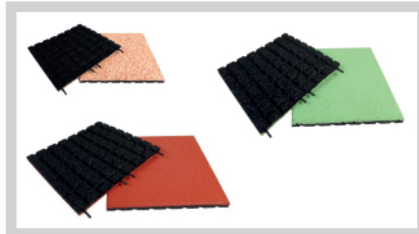

34/ Deska s trávou



35/ Deska s parketovým vzorem



36 a 37/ Vrtání, kolíky a spojovací prvky

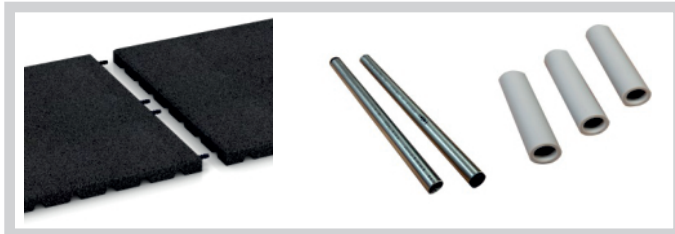

DESKY PODLAHOVÉ



...těsní hned

Podlahové desky slouží jako izolační, bezpečnostní a ochranná krytina. Druh použitého materiálu lze libovolně volit dle použití v exteriéru či interiéru, dále dle stupně hořlavosti či požadované odolnosti vůči chemikáliím, olejům, benzínu a řadě dalších látek.



DESKY PODLAHOVÉ - PRYŽOVÉ

Standardní rozměr je 1200x10000mm skladem i šířky 1400/1500/1800/2000mm, ceny a dostupnost na vyžádání.

Desky podlahové - pryžové		Cena		
č.	název	 tloušťka	1 - 11,99m ²	12 - 119,99m ²
1	Rýhovaná deska - malá	3mm	288,70	165,00
		4mm	385,30	220,20
		5mm	593,40	339,10
2	Rýhovaná deska - velká	3mm	340,10	222,20
		4mm	455,10	297,20
3	Rýhovaná deska - speciál	3mm	352,00	201,10
		4mm	474,40	271,10
4	Rýhovaná deska - smíšená	3mm	352,20	228,10
		4mm	477,90	309,40
		5mm	603,60	390,90
		6mm	729,20	472,30
5	Penízková deska	3mm	352,00	201,10
		4mm	474,60	271,20
		5mm	784,20	448,10
		6mm	945,10	541,80
		7mm	1.274,80	728,50
6	Checker deska	3mm	352,00	201,10
		4mm	474,40	271,10
		5mm	593,00	338,90
7	Kladívková deska	3mm	352,20	228,10
		4mm	477,90	309,40
		5mm	603,60	390,90
		6mm	729,20	472,30
8	Kladívková deska - speciál	8mm	1023,80	663,00
		10mm	1279,00	828,40
		12mm	1535,30	994,20
		15mm	1919,20	1.242,90
9	Kamínková deska	3mm	363,60	235,50
		4mm	484,60	313,80
		6mm	727,40	471,10
		8mm	969,20	627,70
10	Kamínková deska - speciál	12mm	2.101,50	1.360,90
		17mm	2.573,50	1.666,70
11	Kostková deska	8mm	1.049,80	599,80
12		12mm	2.248,20	1.352,30

č.	název	 tloušťka	0,01 - 11,99m ²	od 12m ²
13	Penízková barevná pvc - barevná	3mm	389,70	231,30

1/ Rýhovaná deska - malá

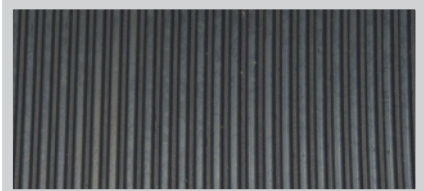

2/ Rýhovaná deska - velká

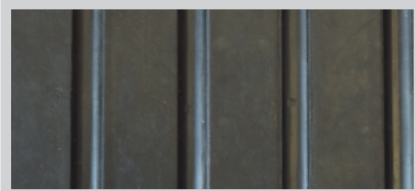

3/ Rýhovaná deska - speciál

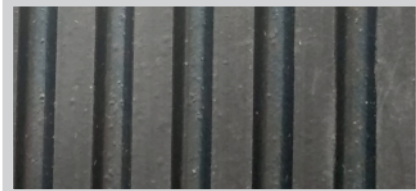

4/ Rýhovaná deska - smíšená

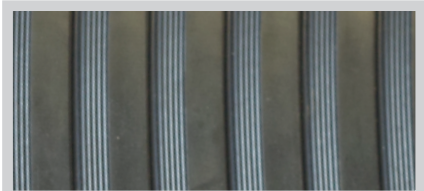

5/ Penízková deska



6/ Checker deska

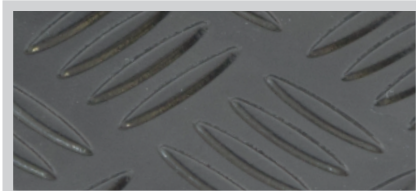

7/ Kladívková deska

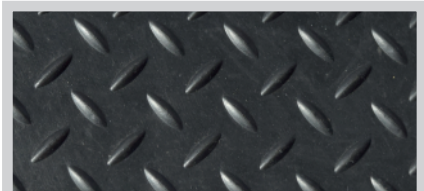

8/ Kladívková deska - speciál

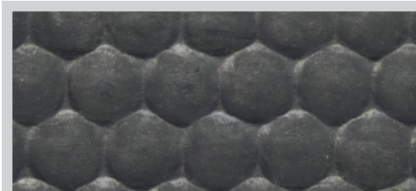

9/ Kamínková deska

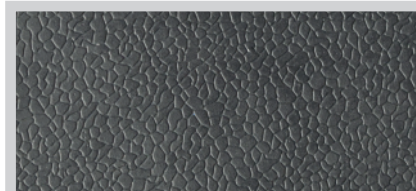

10/ Kamínková deska - speciál



11/ Kostková deska



12/ Caro deska (první strana)

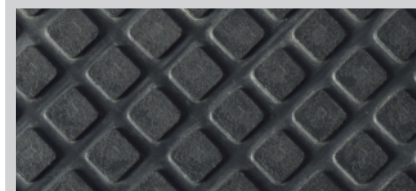

12/ Caro deska - speciál (druhá strana)

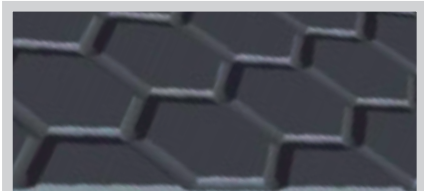

13/ Penízková deska - barevná

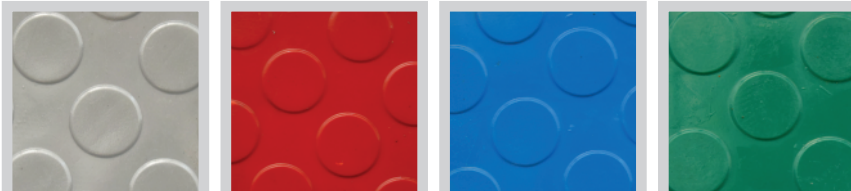

DESKY PODLAHOVÉ - PVC

Desky podlahové - PVC		Cena		
č.	název	 tloušťka	0,01 - 11,99m ²	od 12m ²
1	Rýhovaná deska - malá	2,2mm	261,00	169,00
2	Penízková deska	2,2mm	261,00	169,00
3	Kladívková deska Mřížková deska	2,2mm	261,00	169,00
4	Mřížkovaná deska	2,2mm	261,00	169,00
5	Pyramidová deska	2,2mm	261,00	169,00
6	Pyramidová deska - speciál	3,6mm	270,60	175,30
		4mm	333,90	216,20
7	Čočková deska	2,2mm	261,00	169,00
8	Penízková deska - barevná	2,2mm	261,00	169,00

1/ Rýhovaná deska - malá



2/ Penízková deska



3/ Kladívková deska

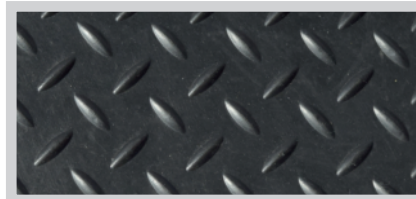

4/ Mřížková deska

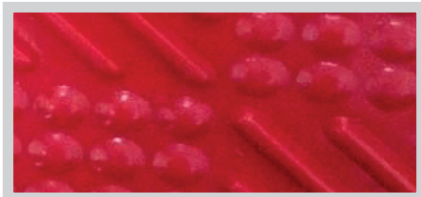

5/ Pyramidová deska

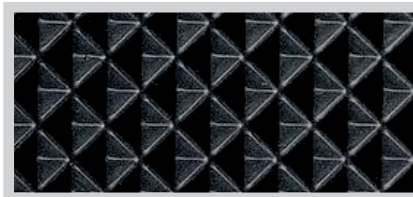

6/ Pyramidová deska - speciál



7/ Čočková deska

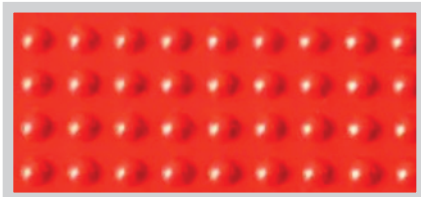

8/ Penízková deska - barevná

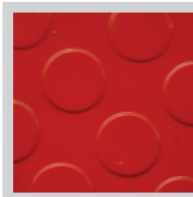
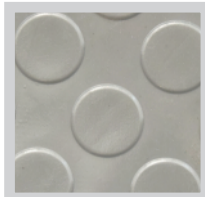

DESKY PODLAHOVÉ - PLASTOVÉ

Desky podlahové - plastové						Cena			
č.	kód ADITEG	Název	Rozměr 	kg/ks	ks/pal	1 - 9 ks	10 - 24 ks	25 - 49 ks	od 50 ks
1	ADI-1019-32	Ponton terénní deska + spoj. zámky	4000x2000x32	330	5	38.021,40	35.486,70	33.268,80	31.311,80
2	ADI-1019A-32	Ponton terénní deska + spoj. zámky	3000x2000x32	264	5	31.220,00	29.138,70	27.317,50	25.710,60
3	ADI-1019-32	Ponton terénní deska + spoj. zámky	4000x1000x32	165	10	21.532,90	20.097,30	18.841,30	17.732,90
4	ADI-1019A-33	Ponton terénní deska + spoj. zámky	3000x1000x32	120	10	18.475,70	17.244,00	16.166,30	15.215,30
5	ADI-1019-43	Zátěžová deska	1200x800x43	32	30	719,10	671,20	629,20	592,20
6	ADI-1029A-43	Zátěžová - slzičková deska	1200x800x43	34	30	761,60	710,80	666,40	627,20
7	ADI-1039-43	Zátěžová deska malá	800x600x43	18	60	361,40	337,30	316,20	297,60
8	ADI-1039R-43	Zátěžový rošt	800x600x43	11	60	284,90	265,90	249,30	234,60
9	ADI-1069-43	Universální interiérová deska	1200x800x43	28,5	30	670,50	625,80	586,70	552,20
10	ADI-1079-22	Kamínková deska malá	800x600x22	11,5	100	275,40	257,00	240,90	226,80
11	ADI-1099Z-22	Interiérová deska malá zesílená plná	80x600x22	12,5	100	275,40	257,00	240,90	226,80
12	ADI-1119-22	Stájová deska malá	800x600x22	10,2	100	255,90	238,90	223,90	210,80
13	ADI-1139-43	Paddock	1200x800x43	28	30	719,10	671,20	629,20	592,20
14	ADI-1139A-43	Paddock děrovaná (Ø25mm, 6x20mm)	1200x800x43	27	30	767,70	716,50	671,70	632,20
15	ADI-1159-22	Interiérová deska	1200x800x22	2020	50	508,20	474,30	444,70	418,50
16	ADI-1159S-22	Interiérová deska - slzičková	1200x800x22	19	50	508,20	474,30	444,70	418,50
17	ADI-1159A-22	Interiérová děrovaná deska (Ø25mm, 6x20mm)	1200x800x22	16,5	50	556,80	519,70	487,20	458,50
18	ADI-1179-12	Interiérová deska hladká	1200x800x22	13,5	60	424,50	396,20	371,50	349,60
19	ADI-1179A-12	Interiérová hladká děrovaná (Ø25mm, 6x20mm)	1200x800x22	16,5	60	470,70	439,30	411,80	387,60
20	ADI-1189-12	Stájová deska hladká	1200x800x22	24	60	424,50	396,20	371,50	349,60
21	ADI-1209-22	Oboustranná interiérová deska	1200x800x22	16,5	50	573,80	439,30	502,10	472,50
22	ADI-1219-12	Kuličková deska hladká	1200x800x22	13,5	60	424,50	396,20	371,50	349,60
23	ADI-1219A-12	Kuličková hladká děrovaná (Ø25mm, 6x20mm)	1200x800x22	13,5	60	470,70	57,00	411,50	387,60
24	ADI-1219P-12	Kuličková deska hladká - puzzle	1158x780x12	11,5	60	561,70	524,30	491,50	462,60
25	ADI-1239-22	Interiérová - kuličková deska malá - vstříkovaná	800x600x22	20	100	275,40	257,00	240,90	226,80
26	ADI-1249-22	Interiérová - kuličková deska	1200x800x22	124	50	508,20	474,30	444,70	418,50
27	ADI-2505-43	Nájezd vysoký „pod“	400x100x43	1,2		76,40	71,30	66,90	62,90
28	ADI-2515-22	Nájezd nízký „pod“	400x100x22	0,6		60,60	56,60	53,10	49,90
29	ADI-2615-22	Nájezd nízký „nad“	400x100x22	0,6		60,60	56,60	53,10	49,90
30	ADI-2625-43	Nájezd vysoký „nad“ jen pro 102	400x100x43	1,2		76,40	71,30	66,90	62,90
31	ADI-2635-43	Nájezd vysoký „nad“ 104, 105, 106, 113	400x100x43	1,2		76,40	71,30	66,90	62,90
32	ADI-2745-43	Spojka vysoká	400x100x43	2		140,80	131,40	123,20	115,90
33	ADI-2795-22	Spojka nízká	400x100x22	1,2		114,10	106,50	99,80	93,90



1-4/ Ponton terénní deska + spoj. zámky

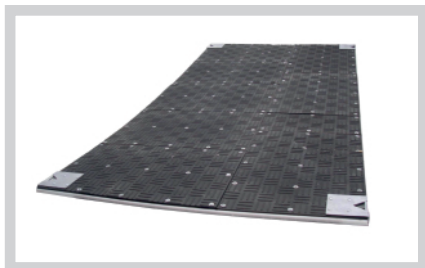

5/ Zátěžová deska

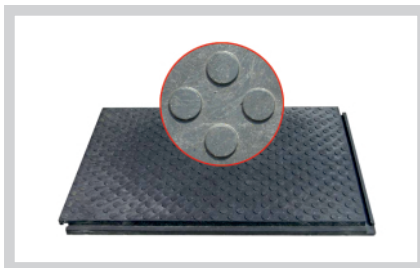

6/ Zátěžová deska - slzičková

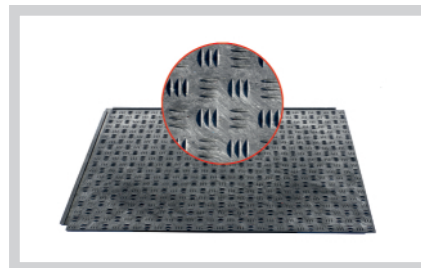

7/ Zátěžová deska - malá



8/ Zátěžový rošt

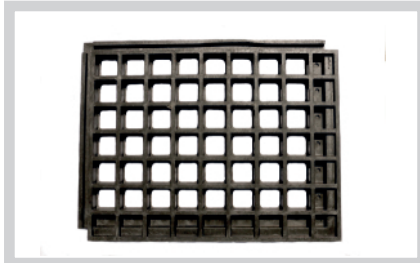

9/ Interiérová deska - univerzální

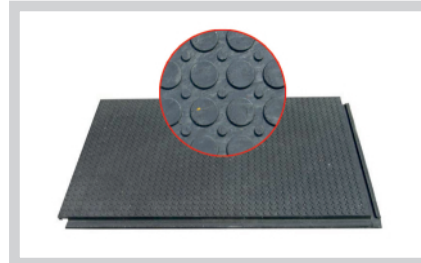

10/ Kamínková deska - malá



11/ Interiérová deska - malá, zesílená

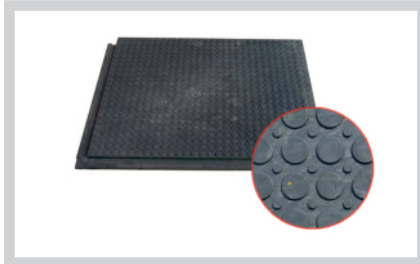

12/ Stájová deska - malá



13/ Paddock deska

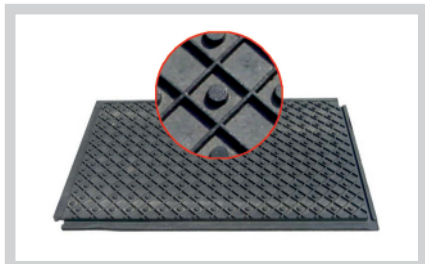

14/ Paddock deska - děrovaná

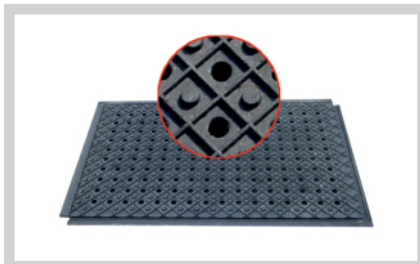

15/ Interiérová deska

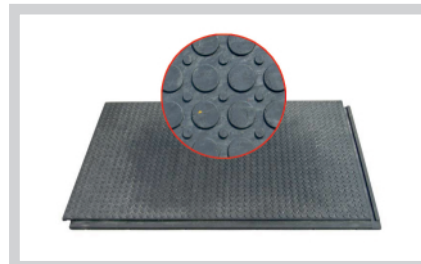

16/ Interiérová deska - slzičková

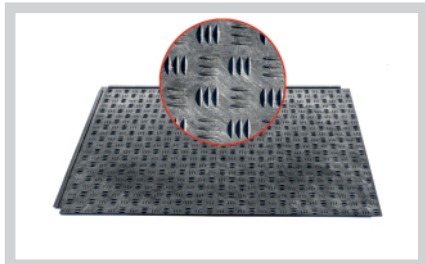

17/ Interiérová deska - děrovaná

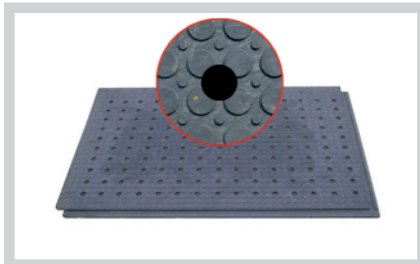

18/ Interiérová deska - hladká

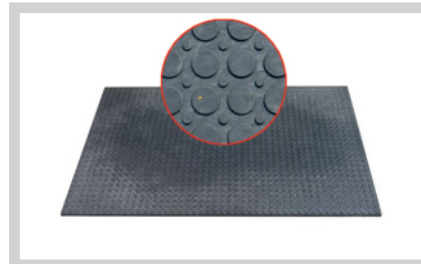

19/ Interiérová deska - hladká, děrovaná

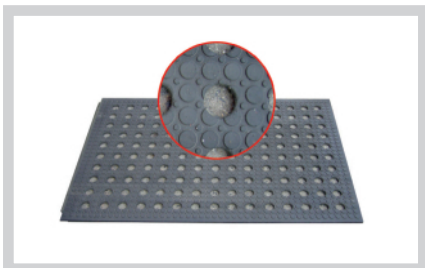

20/ Stájová deska- hladká



21/ Interiérová deska - oboustranná

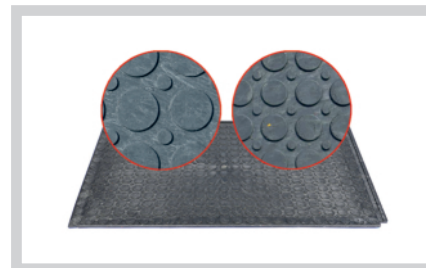

22/ Kuličková deska - hladká

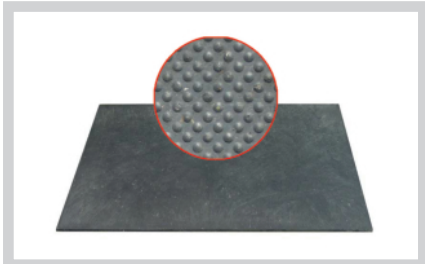

23/ Kuličková deska - hladká, děrovaná

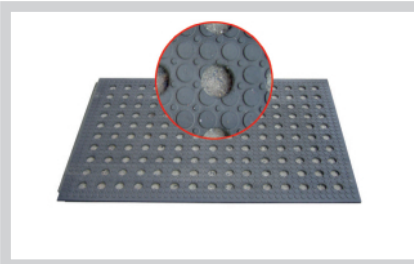

24/ Kuličková deska PUZZLE - hladká

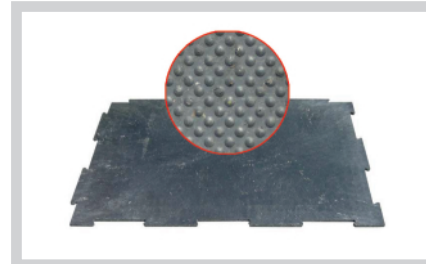

25/ Interiérová kuličková deska - malá

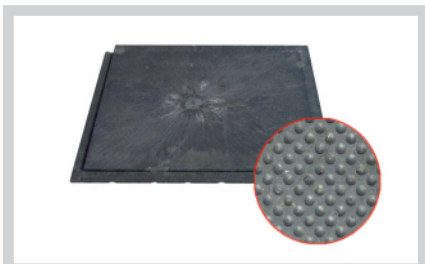

26/ Interiérová deska - kuličková

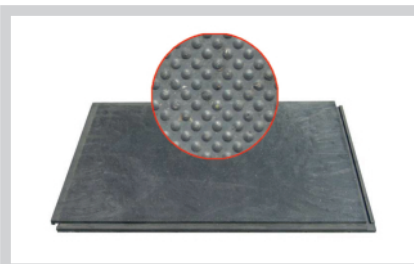

27/ Nájezd vysoký „POD“



28/ Nájezd nízký „POD“



29/ Nájezd nízký „NAD“



30/ Nájezd vysoký „NAD“ jen pro 102



31/ Nájezd vysoký „NAD“ 104, 105, 106, 113

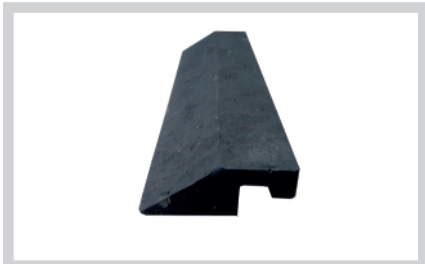

32/ Spojka vysoká

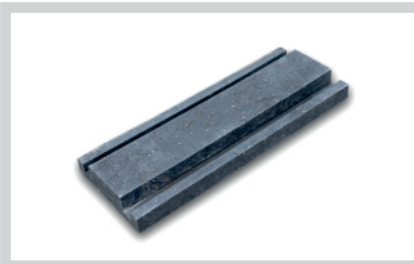

33/ Spojka nízká



GUMOVÉ ROHOŽE

V sortimentu firmy ADITEG s.r.o. naleznete NOVINKU kvalitní gumové rohože, které lze dodat v rozměrech dle dole uvedených mír.

Gumové rohože se hodí nejen do vnitřních, ale i do venkovních objektů.

Kromě čistící funkce získá vchod reprezentativní vzhled, což je důležité pro první dojem návštěvníka.

Vstupní gumové rohože, které jsou ideální nejen pro vstupní prostor, ale také například před schodiště, do dílen, na pracoviště, kde protéká voda, vhodné k pojezdu paletových vozíků s menším nákladem, na parkoviště osobních automobilů. Tyto rohože zvyšují produktivitu, odstraňují hrubé nečistoty, popřípadě sněh, tlumí hluk a působí jako izolace. Rohož představuje komplexní program pro bezpečnost, čistotu a pohodlí. Ideální pro vlhká, blátivá a zasněžená místa. Nabízíme gumové rohože různých velikostí a barev za výhodné ceny.

Výhody a zajímavosti: Rohože obecně se dobře čistí. Jsou tvarovány tak, aby se o ně nezakopávalo.

Okraj rohože často tvoří náběhová hrana, která omezuje možnost zakopnutí či pádu a umožňuje přejezd automobilů.

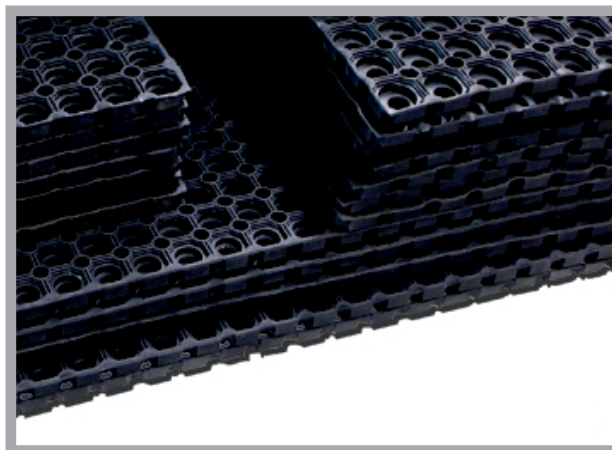
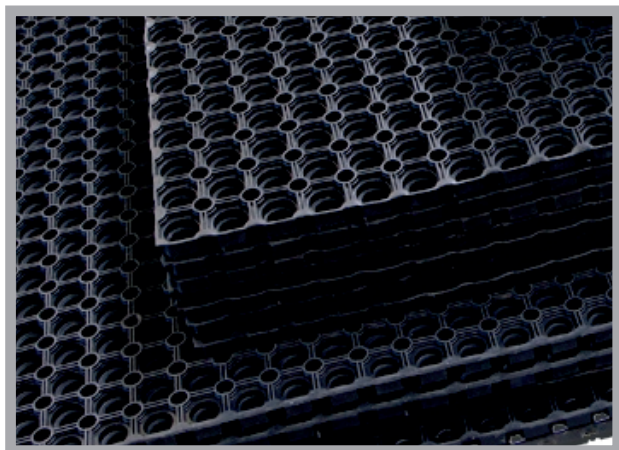
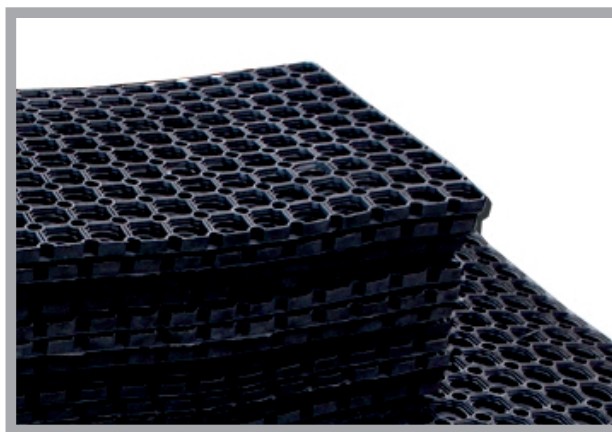
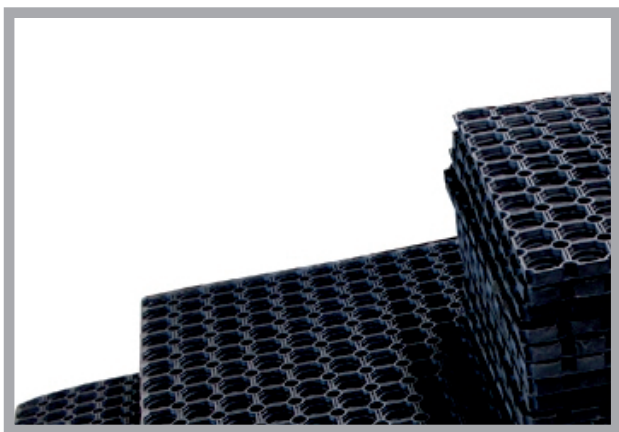

GUMOVÉ ROHOŽE

ROHOŽE PŘED VSTUPNÍ DVEŘE



Gumové rohože - rohože před vstupní dveře					Cena		
č.	kód ADITEG	Rozměr 	1 - 4 ks	5 - 9 ks	10 - 49 ks	50 - 99 ks	od 100 ks
1	101-ADI-welcome	450x750mm	94,80	75,90	63,20	54,20	50,60
2	102-ADI-dírky	400x600mm	67,30	53,80	44,90	38,50	35,90
		400x700mm	72,60	58,10	48,40	41,50	38,70
		450x750mm	127,70	102,20	85,10	73,00	68,10
3	103-ADI-stopa	400x600mm	56,60	45,30	37,70	32,30	30,20
		450x750mm	94,80	75,90	63,20	54,20	50,60
4	104-ADI-list	400x600mm	56,60	45,30	37,70	32,30	30,20
		450x750mm	94,80	75,90	63,20	54,20	50,60
5	105-ADI-kostka	400x600mm	56,60	45,30	37,70	32,30	30,20
		450x750mm	94,80	75,90	63,20	54,20	50,60
6	106-ADI-kočka	400x600mm	56,60	45,60	37,70	32,30	30,20
		450x750mm	94,80	75,90	63,20	54,20	50,60
7	107-ADI-listy	400x600mm	56,60	45,30	37,70	32,30	30,20
8	108-ADI-list/welcome	400x600mm	56,60	45,30	37,70	32,30	30,20
		450x750mm	71,10	56,90	47,40	40,60	37,90
9	109-ADI-dírky	400x600mm	87,20	49,70	58,10	49,80	46,50
		450x750mm	162,90	130,30	108,60	93,10	86,90
10	110-ADI-pes	400x600mm	61,20	48,90	40,80	35,00	32,60
		450x750mm	99,40	79,50	66,30	56,80	53,00
11	111-ADI-pás	450x750mm	196,50	157,20	131,00	112,30	104,80
12	112-ADI-stopa/lavor	400x800mm	129,20	103,40	86,20	73,80	68,90
13	113-ADI-bludiště	400x700mm	71,10	56,90	47,40	40,60	37,90
14	114-ADI-pás/lavor	400x800mm	129,20	103,40	86,20	73,80	68,90
		400x900mm	147,60	118,10	98,40	84,30	78,70
15	115-ADI-caro	400x600mm	87,20	69,70	58,10	49,80	46,50
16	116-ADI-půlkruh	450x750x16mm	119,30	95,40	49,50	68,20	63,60
		450x750x22mm	168,20	134,60	112,20	96,10	89,70
17	117-ADI-welcome/ovál	400x700mm	71,10	56,90	47,40	40,60	37,90
18	118-ADI-kostka	400x700mm	71,10	56,90	47,40	40,60	37,90
19	119-ADI-obdelník	400x700mm	94,80	75,90	63,20	54,20	50,60
20	120-ADI-bludiště/welcome	400x700mm	71,10	56,90	47,40	40,60	37,90

1/ WELCOME



2/ DÍRKY

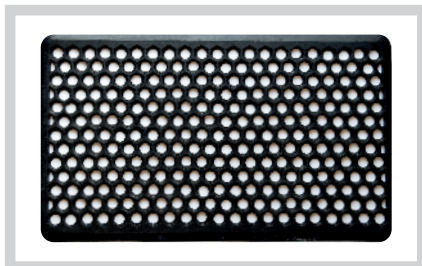

3/ STOPA



4/ LIST



5/ KOSTKA



6/ KOČKA

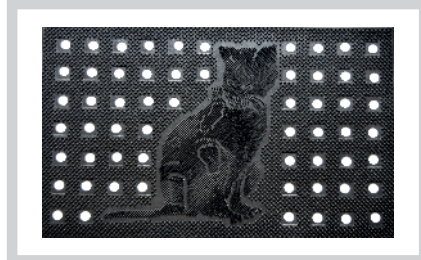

7/ LISTY



8/ LISTY - WELCOME



9/ DÍRKY

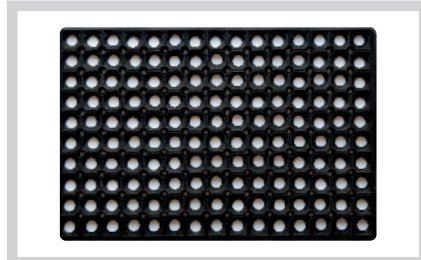

10/ PES

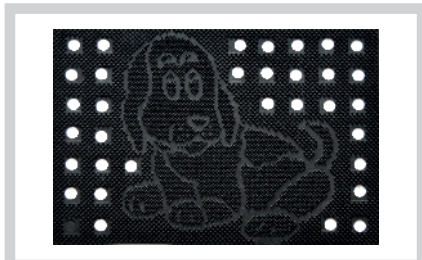

11/ PÁS

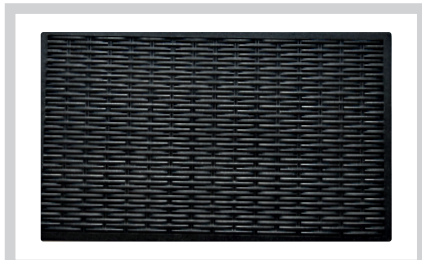

12/ STOPA - LAVOR



13/ BLUDIŠTĚ



14/ PÁS - LAVOR



15/ CARO

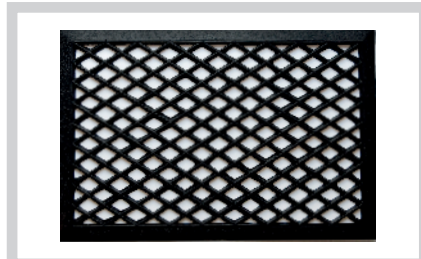

16/ PŮLKRUH

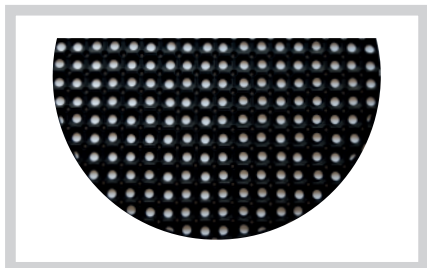

17/ WELCOME - OVÁL

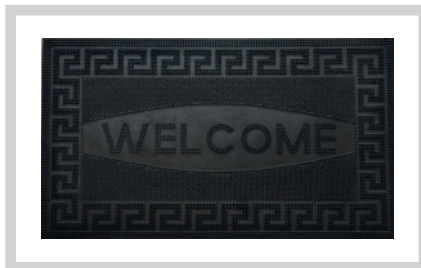

18/ KOSTKA



19/ OBDELNÍK



20/ BLUDIŠTĚ - WELCOME



Gumové rohože				Cena				
č.	kód ADITEG	rozměr 	barva	1 - 4 ks	5 - 9 ks	10 - 49 ks	50 - 99 ks	od 100 ks
1	ADITEG-402	1524x914x12mm	● černá	640,80	587,30	542,10	503,50	469,80
		1524x914x12mm	● červená	855,70	784,40	721,00	672,40	627,50
2	ADITEG-404	1000x1000x13mm	● černá	559,80	513,00	473,60	439,80	410,40
3	ADITEG-404-C	1800x1000x22mm	● černá	676,40	619,90	572,30	531,40	496,00
		1200x800x22mm	● černá	468,40	429,40	396,30	368,00	343,40
		1000x500x22mm	● černá	180,90	165,90	153,00	142,10	132,70
		800x500x22mm	● černá	158,00	144,70	133,60	124,10	115,90
		600x400x22mm	● černá	81,30	74,50	68,80	63,90	59,70
		1800x1000x16mm	● černá	595,60	546,00	504,00	468,10	436,90
		1200x800x16mm	● černá	368,20	337,60	311,60	289,30	270,0
		1000x500x16mm	● černá	157,40	144,30	133,20	123,70	115,30
4	ADITEG-406	800x500x16mm	● černá	155,50	142,60	131,70	122,30	114,00
		600x400x16mm	● černá	65,70	60,30	55,50	51,60	48,10
		1500x900x12mm	● černá	533,80	489,20	451,70	419,50	391,50
		1524x914x12mm	● červená	902,10	827,00	763,30	708,80	661,60
5	ADITEG-407	910x910x12mm	● černá	265,10	243,00	224,30	208,30	194,40
		910x910x14mm	● černá	330,50	303,00	279,60	259,70	242,50
		915x915x12mm	● červená	637,00	584,00	538,90	500,60	467,20
6	ADITEG-408	1500x900x22mm	● černá	915,40	845,00	784,60	732,20	686,60
		1500x900x22mm	● červená	1.252,20	1.155,90	1.073,30	1.001,80	939,20
7	ADITEG-409	1200x800x20mm	● černá	984,40	908,60	843,80	787,50	738,30
8	ADITEG-410	1200x800x20mm	● černá	984,40	908,60	843,80	787,50	738,30
9	ADITEG-411	500x500x8mm	● černá	180,00	166,10	154,30	144,00	135,00
10	ADITEG-412	390x390x25mm	● černá	253,20	230,40	217,00	205,00	189,90
11	ADITEG-413	1500x1000x23mm	● černá	830,50	808,90	787,30	746,60	699,80
12	ADITEG-414	1000x1000x17mm	● černá	949,50	876,50	815,90	759,60	712,10
13	ADITEG-415	910x910x14mm	● černá	379,70	350,50	325,40	303,80	284,80
14	ADITEG-416	1500x900x10,5mm	● černá	548,40	506,30	470,10	438,80	411,30
15	ADITEG-417	910x910x16mm	● černá	432,60	399,30	370,80	346,10	324,40
16	ADITEG-418	900x600x15mm	● černá	195,20	180,20	167,30	156,20	146,40
		1200x900x15mm	● černá	395,40	365,00	338,90	316,40	296,60
17	ADITEG-419	1800x900x8mm	● černá	738,60	681,80	633,10	590,90	553,90
		1500x900x8mm	● černá	685,70	632,90	587,70	548,60	514,30
		1000x600x8mm	● černá	200,30	184,80	171,60	160,20	150,20
		750x450x8mm	● černá	92,80	85,70	79,60	74,30	69,60
		600x400x8mm	● černá	48,40	44,70	41,50	38,70	36,30

1/ ADITEG-402

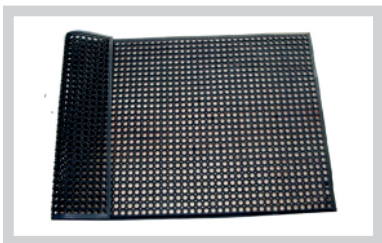

2/ ADITEG-404

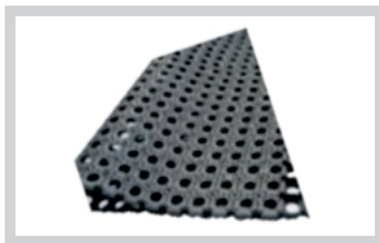

3/ ADITEG-404-C

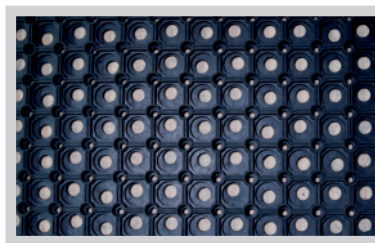

4/ ADITEG-406

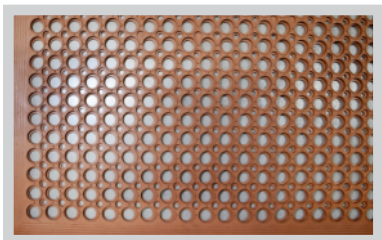

5/ ADITEG-407

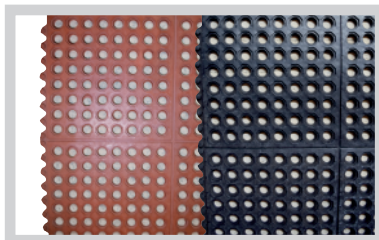

6/ ADITEG-408

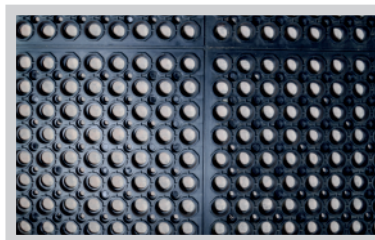

7/ ADITEG-409

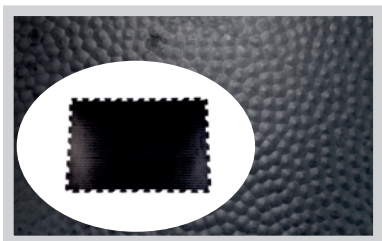

8/ ADITEG-410

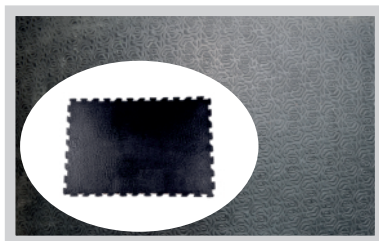

9/ ADITEG-411

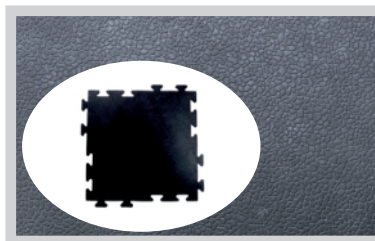

10/ ADITEG-412



11/ ADITEG-413

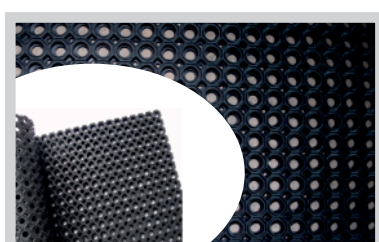

12/ ADITEG-114



13/ ADITEG-415

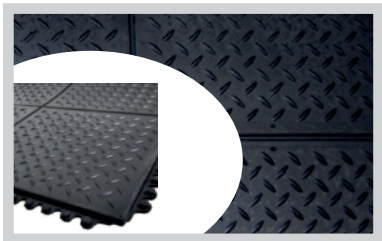

14/ ADITEG-416



15/ ADITEG-417

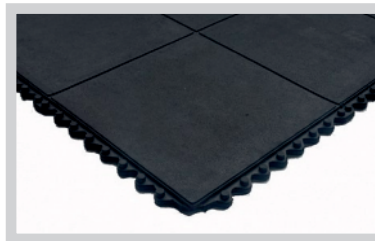

16/ ADITEG-418

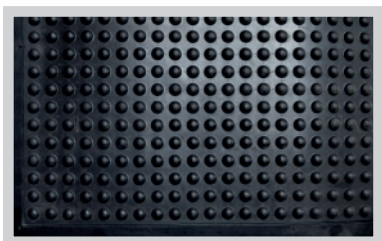

17/ ADITEG-419

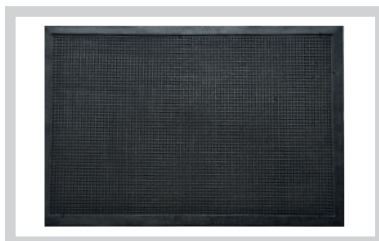



Plastová rohož s tzv. špagetovým (nudlovým) efektem, který pomocí zapletených vlasců vytvoří pevný a odolný základ zachycující špínu, nečistoty i přebytečnou vlhkost

Povrch rohože je velmi měkký a příjemný, proto lze využít i pro bosou nohu jako rohož k bazénu a do sprch.

Spodní část rohože není uzavřená, proto nahromaděná voda odtéká spodem mimo povrch rohože

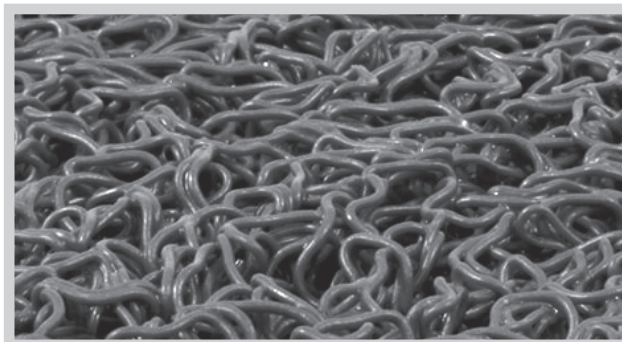
- výrazný protiskluzový účinek
- rohož tlumí a odlehčuje páteřním obratlům
- nehořlavá a odolná olejům
- možné použít jako interiérová i exteriérová rohožka
- jednoduchá údržba vyklepáním, odsátím, vymytím vodou a běžnými čistícími prostředky



Desky protiskluzové - mat. PVC		Cena	
	tloušťka	0,01 - 17,99m ²	18 - 179,99m ²
	12mm	754,20	488,50
	15mm	919,30	595,30

GUMOVÉ ROHOŽE

KOUPELNOVÉ PROTISKLUZOVÉ



Koupelnové protiskluzové rohožky PVC			Cena				
č.	název	rozměr 	1 - 5 ks	6 - 24 ks	25 - 99 ks	100 - 199 ks	od 200 ks
1	Kytka	595x595mm	123,10	114,90	107,80	101,40	95,80
2	Ovál	700x395mm	104,40	97,50	91,40	86,00	81,20
3	Obdélník	595x350mm	84,00	78,40	73,50	69,20	65,30
4	Kruh	Ø 540mm	123,00	114,80	107,70	101,30	95,70
5	Kočka	565x500mm	96,90	90,40	84,80	79,80	75,30
6	Půlkruh	595x400mm	89,00	83,10	77,90	73,30	69,20
7	WC předložka	595x595mm	130,60	121,90	114,30	107,50	101,60
8	Delfín	595x200mm	117,70	109,80	103,00	96,90	91,50
9	Mušle	555x485mm	114,40	106,80	100,10	94,20	89,00

1/ KYTKA

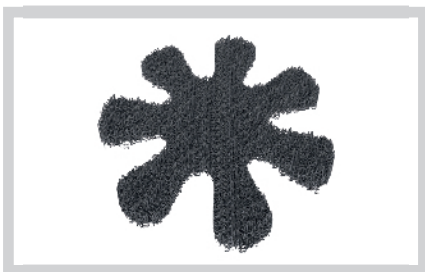

2/ OVÁL

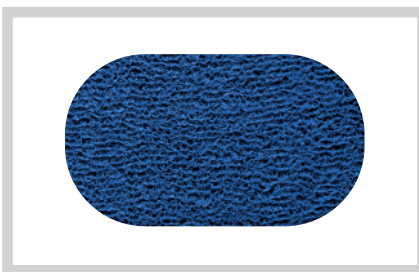

3/ OBDELNÍK

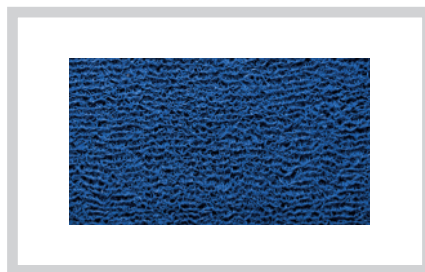

4/ KRUH



5/ KOČKA

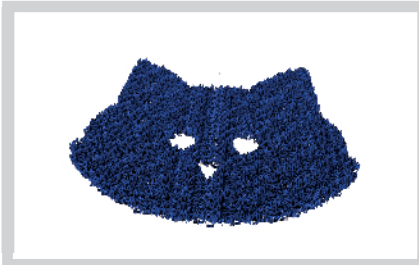

6/ PŮLKRUH

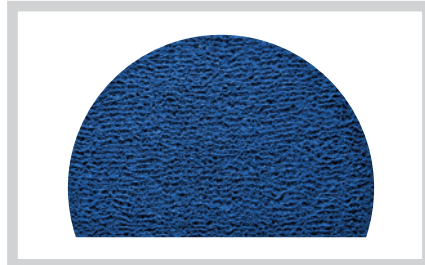

7/ WC PŘEDLOŽKA



8/ DELFÍN

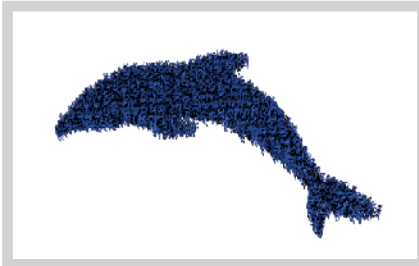

9/ MUŠLE

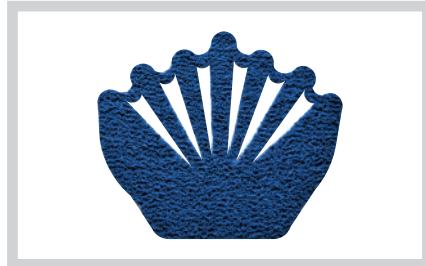





GUMOVÉ DESKY PRO KOŇSKÉ STÁJE

ADITEG, G jako guma, to je pohodlí pro Vaše koně....

Vybavte stáje skotu, koní a kotce psů kvalitními tepelně izolovanými deskami (tzv. stájovou gumou). Naše stájové podlahové gummy a podlahové desky pro zvířecí kotce jsou vyrobeny ze SBR 65 +/- 5 Sha.

- zvýšení komfortu koní ve stáji
- protiskuzové, pružné, měkké
- udržují teplo
- snižují hluk, tlumí nárazy, zamezují zranění zvířat
- menší spotřeba podestýlky, nižší finanční náklady
- k údržbě stačí pouze opláchnutí vodou

Gumové desky pro koňské stáje				Cena				
č.	ADITEG	rozměr 	barva	1 - 4 ks	5 - 9 ks	10 - 49 ks	50 - 99 ks	od 100 ks
1	ADITEG-411	500x500x8mm	● černá	180,00	166,10	154,30	144,00	135,00
2	ADITEG-412	390x390x25mm	● černá	253,20	230,40	217,00	205,00	189,90
3	ADITEG-415	910x910x14mm	● černá	379,70	350,50	325,40	303,80	284,80
4	ADITEG-417	910x910x16mm	● černá	432,60	399,30	370,80	346,10	324,40
5	ADITEG-414	1000x1000x17mm	● černá	949,50	876,50	815,90	759,60	712,10
6	ADITEG-423	1000x1000x18mm	● černá	1.149,30	1.021,60	919,40	835,80	766,20
7	ADITEG-410	1200x800x20mm	● černá	984,40	908,60	843,80	787,50	738,30
8	ADITEG-409	1200x800x20mm	● černá	984,40	908,60	843,80	787,50	738,30
č.	ADITEG	rozměr 	barva	0,01 - 11,99 m ²	12 - 99,99 m ²	od 100 m ²		
9	Reggranulát	1250x10000x8mm	● černá	200,40	167,00	154,20		
		1250x6000x10mm	● černá	240,80	200,70	185,30		
		1250x6000x12mm	● černá	291,20	242,70	224,00		
		1150x2300x15mm	● černá	342,30	285,20	263,50		
		1150x2300x20mm	● černá	494,70	412,30	380,60		
10	Deska ADITEG - kostková	1250x10000x8mm	● černá	749,80	583,20	403,80		
č.	ADITEG	rozměr 	barva	0,00 - 11,16 m ²	11,17 - 111,62 m ²	od 111,63 m ²		
11	Deska ADITEG - kamínková speciál	1220x1830x12mm	● černá	693,90	449,40	390,77		
		1220x1830x17mm	● černá	971,10	628,90	546,90		
12	Deska ADITEG - Caro / Caro speciál	1220x1830x12mm	● černá	1.405,20	1.124,20	864,80		
č.	ADITEG	rozměr 	barva	0,01 - 9,99 m ²	10 - 29,99 m ²	30 - 49,99 m ²	50 - 99,99 m ²	od 100 m ²
13	ADITEG-422	1000x2000x10mm	● černá	959,60	852,90	767,60	697,90	639,70
		1000x2000x15mm	● černá	1.404,40	1.248,40	1.123,50	1.021,40	936,30
		1000x2000x20mm	● černá	1.775,70	1.578,40	1.420,60	1.291,40	1.183,80

1/ ADITEG-411

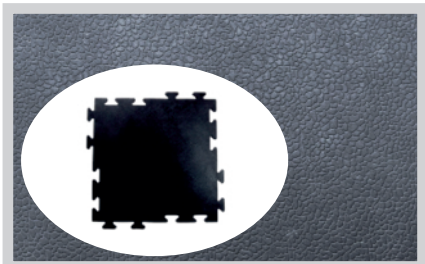

2/ ADITEG-412

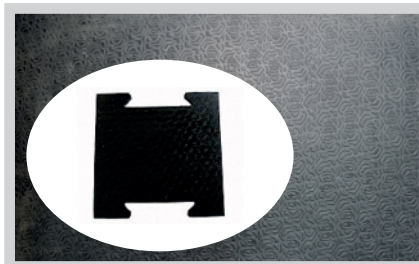

3/ ADITEG-415

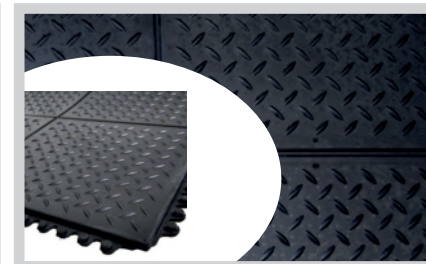

4/ ADITEG-417

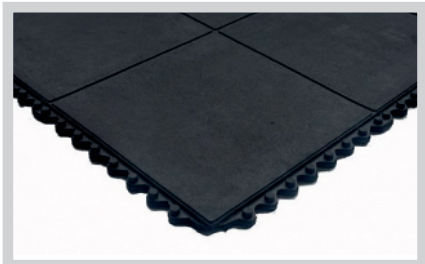

5/ ADITEG-414

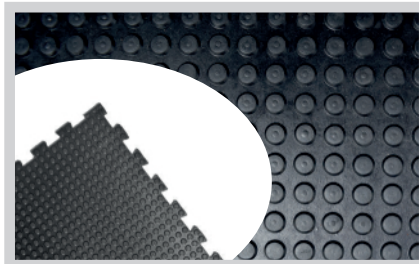

6/ ADITEG-423



7/ ADITEG-410

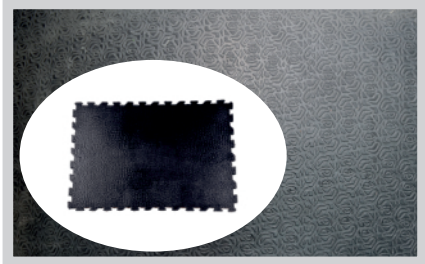

8/ ADITEG-409

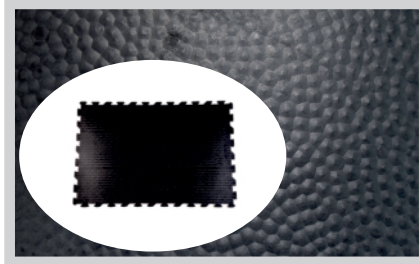

9/ REGRANULÁT



10/ ADITEG - kostková

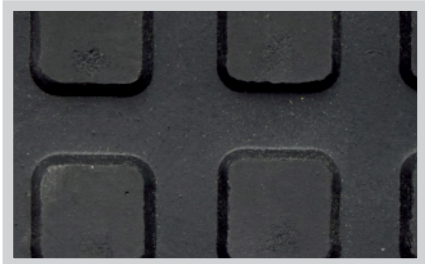

11/ ADITEG - kamínková speciál

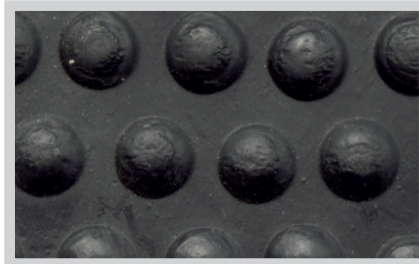

12/ ADITEG - Caro



12/ ADITEG - Caro speciál

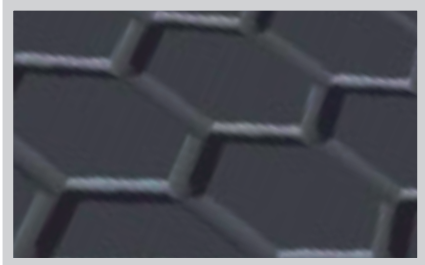

13/ ADITEG - 422

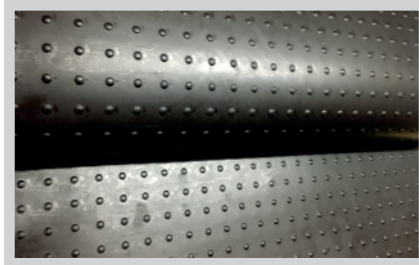

BEZAZBESTOVÉ TĚSNÍCÍ DESKY ADISEAL

ADISEAL - bezazbestové těsnící desky, deskové těsnící vláknitopolymerní CSF

Bezazbestové těsnící desky mají široké využití ve všech odvětvích průmyslu, jako například automobilový průmysl, strojírenství atd.

Použití: voda, plyny, oleje, alkoholy, základní chemikálie

Certifikace: Germanischer Lloyd, KTW

- surová váha DIN 28 090 - 2: 1,9 - 2,2g/cm²
- barva: červená, žlutá, modrá
- odolnost vůči teplotě (trvale): +140°C
- odolnost vůči teplotě (krátkodobě): +210°C
- odolnost vůči páře: +120°C
- pevnost v tahu DIN 52913: >22 Mpa
- stlačitelnost ASTM F 36 - J 5: -15%
- zotavení ASTM F 36 - J: min. 50%
- spec. množ. netěsnosti DIN 3535 - 6: 0,15 mg/(s.m)
- formát desek: 1500x1500mm

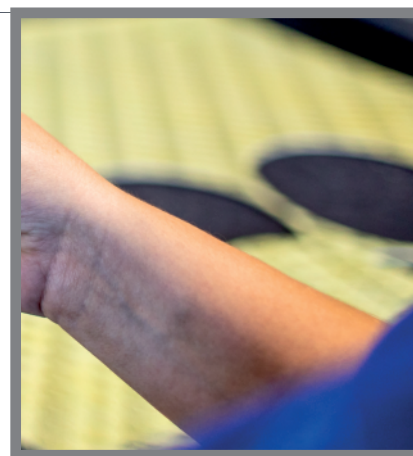
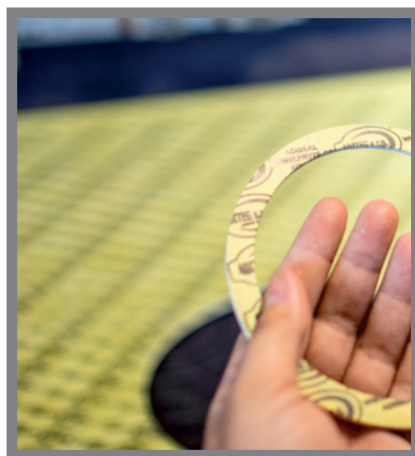

Jiné materiály dle konkrétní poptávky.

Bezazbestové desky		Cena		
	tloušťka	0,01 - 2,24 m ²	2,25 - 11,24 m ²	OD 11,25 m ²
	0,5 mm	351,90	281,50	239,30
	1,0 mm	405,90	324,70	276,10
	1,6 mm	543,20	434,50	292,10
	2,0 mm	623,60	498,80	423,90
	3,0 mm	820,90	656,60	558,20
	4,0 mm	1.115,60	892,50	758,70
	5,0 mm	1.394,60	1.109,10	948,30

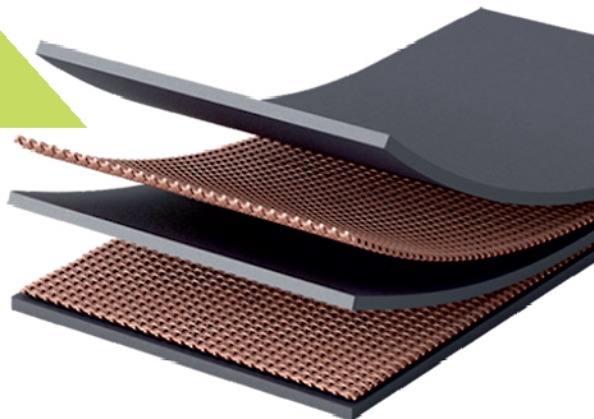

DOPRAVNÍKOVÉ PÁSY



Dopravníkové pásy				Cena				
Typ	vložky	 tloušťka	 šíře mm	0 - 9,99 bm	10 - 24,99 bm	25 - 49,99 bm	50 - 99,99 bm	od 100 bm
EP250/2Y	2	6,5 mm	400	277,30	256,00	237,70	211,80	208,00
			500	346,40	319,80	296,90	277,10	259,80
			650	450,40	415,70	386,00	360,30	337,80
			800	554,30	511,60	475,10	443,40	415,70
			1000	692,90	639,60	593,90	554,30	519,60
EP315/2AA	2	7 mm	400	307,90	284,20	263,90	246,30	230,90
			500	384,90	355,30	329,90	307,90	288,70
			650	500,30	461,90	428,90	400,30	375,30
			800	615,80	568,40	527,80	492,70	461,90
			1000	769,80	710,60	659,80	615,80	577,40
EP400/3Y	3	9 mm	400	388,00	358,10	332,60	310,40	291,00
			500	485,00	447,70	415,70	388,00	363,70
			650	630,40	581,90	540,40	504,40	472,80
			800	1.746,00	1.611,70	1.496,60	1.396,80	1.309,50
			1000	970,00	895,40	831,40	776,00	727,50
EP500/3AA	3	9 mm	400	404,90	313,70	347,00	323,90	303,60
			500	506,80	467,80	434,40	405,40	380,10
			650	657,90	607,30	563,90	526,30	493,40
			800	809,70	747,40	694,00	647,80	607,30
			1000	1.012,10	934,30	867,50	809,70	759,10
EP630/3AA	3	10 mm	400	486,20	448,80	416,80	389,00	364,70
			500	607,80	561,00	521,00	486,20	455,80
			650	790,10	729,30	677,20	632,10	592,60
			800	972,40	897,60	833,50	777,90	729,30
			1000	1.215,50	1.122,00	1.041,90	972,40	911,60
EP630/4A	4	12,2 mm	400	547,40	505,30	469,20	437,90	410,60
			500	684,30	631,70	586,50	547,40	513,20
			650	889,60	821,10	762,50	711,60	667,20
			800	1.094,80	1.010,60	938,40	875,80	821,10
			1000	1.368,50	1.263,30	1.173,00	1.094,80	1.026,40
			1200	1.642,20	1.515,90	1.407,60	1.313,80	1.231,70



PTFE - DESKY / TYČE



...těsní hned

PTFE desky

PTFE deska		Cena	
tloušťka	rozměr	0,01 - 7,19 m2	od 7,20 m2
0,3mm	1200x1200mm	441,96	331,47
0,5mm	1200x1200mm	563,73	422,79
0,7mm	1200x1200mm	789,22	591,91
1mm	1200x1200mm	1.127,45	845,59
1,5mm	1200x1200mm	1.691,18	1.268,38
2mm	1200x1200mm	2.254,90	1.691,18
2,5mm	1200x1200mm	2.818,63	2.113,97
3mm	1200x1200mm	3.382,35	2.536,76
4mm	1200x1200mm	4.509,80	3.382,35
5mm	1200x1200mm	5.637,25	4.227,94
6mm	1200x1200mm	6.764,71	5.073,53
8mm	1200x1200mm	7.816,99	5.862,75
9mm	1200x1200mm	8.794,12	6.595,59
10mm	1200x1200mm	9.771,24	7.328,43



PTFE tyče

PTFE tyč	Cena	
průměr	0,01 - 9,99 m	od 10,00 m
10mm	88,80	64,60
20mm	355,47	258,52
30mm	799,77	581,65
40mm	1.421,80	1.034,03
50mm	2.221,64	1.615,74
60mm	3.199,06	2.326,59
70mm	4.354,38	3.166,82
80mm	5.687,34	4.136,25
90mm	7.197,97	5.234,89
100mm	8.886,41	6.462,84
110mm	10.752,73	7.820,17
120mm	12.796,09	9.306,25
130mm	15.017,97	10.922,16
140mm	17.417,00	12.667,05
150mm	19.994,53	14.541,48



PTFE pásky

Funkce: Vyrobená ze 100% čistého, expandovaného PTFE, jednostranně samolepící páska pro snadnou instalaci. Vysoká chemická odolnost, vynikající proti tečení, proti stárnutí, povětrnostním vlivům a UV stabilní. Efektivní utěsnění nerovných povrchů. Vhodná při instalaci, vysokotlaká, stabilní a má vynikající přizpůsobivost.

Rychlá a snadná instalace.

Univerzální použití jako statická těsnění téměř ve všech průmyslových odvětvích, ale především jako těsnění pro trvalé příruby v podobných aplikacích.

Fyziologicky nezávadná, bez chuti, bez zápachu, nemůže být napadena nebo rozkládána mikroorganismy.

Požadavky FDA 21CFR regulace 177,1550 a nařízení EU č. 1935/2004 jsou splněny.

Certifikát dle DVGW, BAM a FDA.

Teplotní odolnost materiálu: -240 stupňů Celsia, +270 stupňů Celsia, +315 stupňů Celsia krátkodobě

PTFE pásky		Cena		
rozměr	0,01 - 99,99 bm	100 - 199,99 bm	od 200 bm	
3 x 1,5mm	22,60	21,10	19,80	
5 x 2mm	28,20	26,30	24,70	
6 x 4mm	43,70	40,70	38,20	
7 x 2,5mm	31,60	29,50	27,70	
10 x 3mm	49,70	46,40	43,50	
12 x 4mm	66,20	61,80	57,90	
14 x 5mm	96,30	89,90	84,30	
20 x 5mm	136,90	127,80	119,80	
17 x 6mm	143,90	133,40	124,90	
20 x 7mm	159,40	148,80	139,50	



Pryžkovové antivibrační prvky (silentbloky) jsou součástky určené k pružnému uložení, tlumení nárazů, aktivní i pasivní izolaci svyslých i příčných kmitů, hlukové izolaci, přenosu sil, ochrannému uložení a podobně. Pro montáž jsou opatřeny šroubem, čili závitem venkovním nebo závitem vnitřním či kombinací jednotlivých možností pro uchycení.

Pro snadné rozlišení rozdělujeme silentbloky podle způsobu uchycení na pět základních typů:

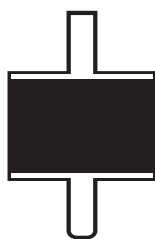

Typ A
oboustranný závit
venkovní



Typ B
oboustranný závit
venkovní / vnitřní



Typ C
oboustranný závit
vnitřní

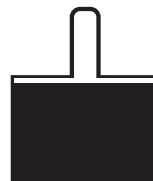

Typ D
jednostranný závit
venkovní



Typ E
jednostranný závit
vnitřní

Silentbloky se vyrábí z elastomeru v široké škále tvarů, průměrů a délek. Nejčastěji se však využívají silentbloky válcové.



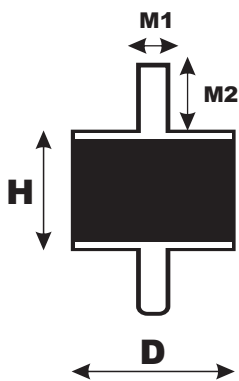

SILENTBLOKY - TYP A

OBOUSTRANNÝ ZÁVIT VENKOVNÍ

D	H	M1xM2	1 - 9 ks	10 - 24 ks	25 - 49 ks	50 - 99 ks	100 - 199 ks
15	8	M4x10	11,10	8,90	8,10	7,40	6,90
	10	M4x10	12,00	9,60	8,80	8,00	7,40
	15	M4x10	12,00	9,60	8,80	8,00	7,40
	20	M4x10	12,20	9,70	8,80	8,10	7,50
	30	M4x10	12,30	9,80	9,00	8,20	7,60
20	8	M6x18	15,30	12,30	11,20	10,20	9,40
	10	M6x18	15,70	12,50	11,40	10,50	9,70
	13,5	M6x18	15,90	12,70	11,60	10,60	9,80
	15	M6x18	16,30	13,00	11,80	10,80	10,00
	20	M6x18	17,20	13,70	12,50	11,40	10,60
	25	M6x18	17,70	14,20	12,90	11,80	10,90
	30	M6x18	18,30	14,60	13,30	12,20	11,30
25	10	M6x18	22,30	17,80	16,20	14,80	13,70
	15	M6x18	24,10	19,30	17,50	16,10	14,80
	20	M6x18	24,50	19,60	17,90	16,40	15,10
	25	M6x18	24,90	19,90	18,10	16,60	15,30
	30	M6x18	25,80	20,60	18,80	17,20	15,90
30	15	M6x18	26,40	23,10	20,90	19,40	18,20
	20	M6x18	33,20	26,50	24,10	22,10	20,40
	25	M6x18	34,70	27,70	25,20	23,10	21,30
	30	M6x18	36,10	28,90	26,30	24,10	22,20
40	40	M6x18	39,10	31,30	28,40	26,10	24,10
	20	M8x23	37,60	30,10	27,40	25,10	23,10
	30	M8x23	42,50	34,00	30,90	28,30	26,20
50	40	M8x23	50,50	40,40	36,70	33,60	31,00
	20	M10x28	61,30	49,00	44,50	40,80	37,70
	25	M10x28	64,10	51,30	46,60	42,70	39,40
	30	M10x28	68,50	54,80	49,80	45,70	42,20
	35	M10x28	72,00	57,60	52,40	48,00	44,30
	40	M10x28	75,80	60,60	55,10	50,50	46,60
60	45	M10x28	78,80	63,00	57,30	52,50	48,50
	50	M10x28	83,20	66,50	60,50	55,50	51,20
	30	M12x37	101,00	80,80	73,50	67,30	62,20
70	40	M12x37	103,40	82,70	75,20	68,90	63,60
	35	M12x32	123,20	98,50	89,60	82,10	75,80
75	45	M12x32	130,60	104,50	95,00	87,00	80,30
	25	M12x37	158,00	126,40	114,90	105,30	97,20
	40	M12x37	181,80	145,50	132,20	121,20	111,90
	50	M12x37	200,80	160,60	146,00	133,90	123,60
100	55	M12x37	214,80	171,80	156,20	143,20	132,20
	30	M16x42	326,60	261,30	237,50	217,70	201,00
	40	M16x42	337,00	269,60	245,10	224,70	207,40
	50	M16x42	369,20	295,40	268,50	246,10	227,20
	55	M16x42	380,90	304,70	277,00	253,90	234,40
	60	M16x42	395,50	316,40	287,60	263,60	243,40
150	75	M16x42	439,30	351,50	319,50	292,90	270,30
	45	M16x42	936,90	749,50	681,40	624,60	576,60
	50	M16x42	975,00	780,00	709,10	650,00	600,00
	55	M16x42	1004,20	803,40	730,30	669,50	618,00
	60	M16x42	1039,20	831,40	755,80	692,80	639,50
75	M16x42	1138,50	910,80	828,00	759,00	700,60	

SILENTBLOKY - TYP B

OBOUSTRANNÝ ZÁVIT VENKOVNÍ / VNITŘNÍ

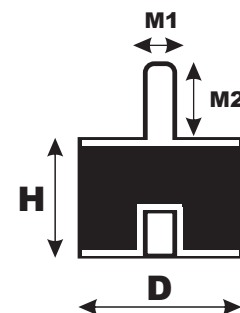

D	H	M1xM2	1 - 9 ks	10 - 24 ks	25 - 49 ks	50 - 99 ks	100 - 199 ks
15	8	M4x10	18,30	14,60	13,30	12,20	11,30
	10	M4x10	24,30	15,30	13,90	12,70	11,70
	15	M4x10	19,10	15,30	13,90	12,70	11,70
	20	M4x10	19,30	15,50	14,00	12,90	11,90
	30	M4x10	19,40	15,50	14,10	13,00	12,00
20	8	M6x18	25,10	20,10	18,30	16,70	15,50
	10	M6x18	25,50	20,40	18,50	17,00	15,70
	13,5	M6x18	25,70	20,50	18,70	17,10	15,80
	15	M6x18	26,00	20,80	18,90	17,30	16,00
	20	M6x18	26,90	21,50	19,60	18,00	16,60
	25	M6x18	27,50	22,00	20,00	18,30	16,90
	30	M6x18	28,10	22,50	20,40	18,70	17,30
25	10	M6x18	31,50	25,20	22,90	21,00	19,40
	15	M6x18	33,20	26,50	24,10	22,10	20,40
	20	M6x18	33,60	26,90	24,50	22,40	20,80
	25	M6x18	34,10	27,30	24,80	22,70	21,00
	30	M6x18	34,60	28,00	25,50	23,30	21,50
30	15	M6x18	37,10	31,50	29,50	25,50	22,50
	20	M6x18	40,50	32,40	29,40	27,00	24,90
	25	M6x18	41,80	33,50	30,40	27,90	25,70
	30	M6x18	43,30	34,60	31,50	28,90	26,60
	40	M6x18	46,30	37,00	33,60	30,80	28,50
40	20	M8x23	44,30	35,50	32,20	29,50	27,30
	30	M8x23	49,50	39,60	36,00	33,00	30,50
	40	M8x23	58,40	46,70	42,50	38,90	35,90
50	20	M10x28	68,30	54,60	49,70	45,50	42,00
	25	M10x28	71,30	57,00	51,80	47,50	43,80
	30	M10x28	75,60	60,50	55,00	50,40	46,50
	35	M10x28	79,10	63,30	57,50	52,70	48,70
	40	M10x28	83,00	66,40	60,30	55,30	51,00
	45	M10x28	85,80	68,60	62,40	57,20	52,80
	50	M10x28	90,20	72,20	65,60	60,20	55,50
60	30	M12x37	105,60	84,50	76,80	70,40	65,00
	40	M12x37	108,00	86,40	78,50	72,00	66,40
70	35	M12x32	127,80	102,30	93,00	85,20	78,70
	45	M12x32	135,10	108,10	98,30	90,10	83,10
75	25	M12x37	162,50	130,00	118,20	108,30	100,00
	40	M12x37	186,50	149,20	135,60	124,30	114,80
	50	M12x37	205,50	164,40	149,40	137,00	126,40
	55	M12x37	217,70	174,20	158,30	145,20	134,00
100	30	M16x42	328,80	263,00	239,10	219,20	202,30
	40	M16x42	339,20	271,40	246,70	226,10	208,70
	50	M16x42	371,30	297,00	270,00	247,50	228,50
	55	M16x42	383,00	306,40	278,50	255,30	235,70
	60	M16x42	397,60	318,10	289,20	265,10	244,70
	75	M16x42	441,40	353,10	321,00	294,20	271,60
150	45	M16x42	939,10	751,30	683,00	626,10	577,90
	50	M16x42	977,00	781,60	710,60	651,40	601,30
	55	M16x42	1006,30	805,00	731,80	670,80	619,20
	60	M16x42	1041,30	833,00	757,30	694,20	640,80
	75	M16x42	1140,60	912,50	829,50	760,40	701,90

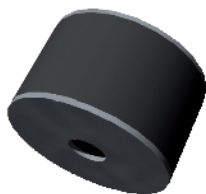
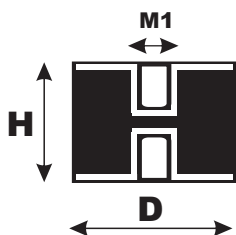

SILENTBLOKY - TYP C

OBOUSTRANNÝ ZÁVIT VNITŘNÍ

D	H	M1	1 - 9 ks	10 - 24 ks	25 - 49 ks	50 - 99 ks	100 - 199 ks
15	8	M4	25,30	20,30	18,40	16,90	15,60
	10	M4	26,30	21,00	19,10	17,50	16,20
	15	M4	26,30	21,00	19,10	17,50	16,20
	20	M4	26,40	21,10	19,20	17,60	16,20
	30	M4	26,50	21,20	19,30	17,70	16,30
20	8	M6	34,90	27,90	25,40	23,30	21,50
	10	M6	35,20	28,20	25,60	23,50	21,70
	13,5	M6	35,50	28,40	25,80	23,60	21,80
	15	M6	35,80	28,60	26,00	23,90	22,00
	20	M6	36,70	29,40	26,70	24,50	22,60
	25	M6	37,30	29,80	23,80	24,80	22,90
	30	M6	37,80	30,30	27,50	25,20	23,30
25	10	M6	40,70	32,50	29,60	27,10	25,10
	15	M6	42,40	33,90	30,80	28,30	26,10
	20	M6	42,80	34,30	31,20	28,60	26,40
	25	M6	43,30	34,60	31,50	28,90	26,60
	30	M6	44,20	35,40	32,10	29,50	27,20
30	15	M6	45,30	36,30	32,90	29,81	27,40
	20	M6	47,60	38,10	34,60	31,70	29,30
	25	M6	49,10	39,30	35,70	32,70	30,20
	30	M6	50,60	40,50	36,80	33,70	31,10
	40	M6	53,40	42,70	38,80	35,60	32,90
40	20	M8	51,10	40,90	37,20	34,10	31,50
	30	M8	56,70	45,40	41,20	37,80	34,90
	40	M8	66,40	53,10	48,30	44,20	40,80
50	20	M10	75,50	60,40	54,90	50,30	46,40
	25	M10	78,30	62,60	56,90	52,20	48,20
	30	M10	82,70	66,20	60,20	55,20	50,90
	35	M10	86,30	69,00	62,70	57,50	53,10
	40	M10	90,00	72,00	65,50	60,00	55,40
	45	M10	93,00	74,40	67,60	62,00	57,20
	50	M10	97,30	77,80	70,70	64,80	59,90
60	30	M12	110,20	88,20	80,20	73,50	67,80
	40	M12	112,60	90,10	81,90	75,10	69,30
70	35	M12	130,40	105,90	96,30	88,30	81,50
	45	M12	139,70	111,70	101,60	93,10	86,00
75	25	M12	167,00	133,60	121,50	111,40	102,80
	40	M12	191,00	152,80	138,90	127,30	117,60
	50	M12	210,00	168,00	152,70	140,00	129,20
	55	M12	220,70	176,50	160,50	158,00	135,80
100	30	M16	330,80	264,60	240,60	220,50	203,60
	40	M16	341,30	273,00	248,20	227,50	210,00
	50	M16	373,40	298,70	271,60	248,90	229,80
	55	M16	385,10	308,10	280,10	256,70	237,00
	60	M16	399,70	319,70	290,70	266,40	245,90
	75	M16	443,50	354,80	322,60	295,70	272,90
150	45	M16	941,10	752,90	684,50	627,40	579,20
	50	M16	979,10	783,30	721,10	652,70	602,50
	55	M16	1008,30	806,60	733,30	672,20	620,50
	60	M16	1043,40	834,70	758,80	695,60	642,10
	75	M16	1142,70	914,20	831,10	761,80	703,20

SILENTBLOKY - TYP D

JEDNOSTRANNÝ ZÁVIT VENKOVNÍ

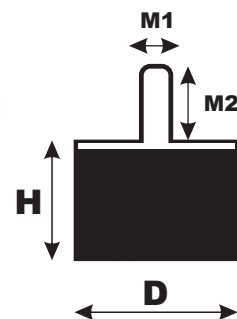

D	H	M1xM2	1 - 9 ks	10 - 24 ks	25 - 49 ks	50 - 99 ks	100 - 199 ks
15	8	M4x10	11,30	9,00	8,20	7,50	6,90
	10	M4x10	12,20	9,70	8,80	8,10	7,50
	15	M4x10	12,20	9,70	8,80	8,10	7,50
	20	M4x10	12,30	9,80	8,90	8,20	7,60
	30	M4x10	12,40	9,90	9,00	8,30	7,60
20	8	M6x18	14,90	11,90	10,80	9,90	9,20
	10	M6x18	15,10	12,10	11,00	10,10	9,30
	13,5	M6x18	15,50	12,40	11,20	10,70	9,50
	15	M6x18	15,70	12,50	11,40	10,50	9,70
	20	M6x18	16,60	13,30	12,10	11,10	10,20
	25	M6x18	17,20	13,70	12,50	11,40	10,60
	30	M6x18	17,70	14,20	12,90	11,30	10,90
25	10	M6x18	19,20	15,40	14,00	12,80	11,80
	15	M6x18	20,70	16,50	15,00	13,80	12,70
	20	M6x18	20,90	16,70	15,20	13,90	12,90
	25	M6x18	21,80	17,50	15,90	14,50	13,40
30	30	M6x18	22,70	18,20	16,50	15,20	14,00
	15	M6x18	23,60	19,90	18,40	17,30	14,50
	20	M6x18	26,40	21,10	19,20	17,60	16,20
	25	M6x18	27,80	22,30	20,20	18,60	17,10
	30	M6x18	29,30	23,50	21,30	19,50	18,70
40	40	M6x18	32,30	25,80	23,50	21,50	19,90
	20	M8x23	28,00	22,40	20,30	18,60	17,20
	30	M8x23	32,60	26,10	23,70	21,70	20,10
	40	M8x23	44,10	35,30	32,10	29,40	27,10
50	20	M10x28	52,40	41,90	38,10	34,90	32,20
	25	M10x28	55,20	44,20	40,20	36,80	34,00
	30	M10x28	59,70	47,70	43,40	39,80	36,70
	35	M10x28	63,20	50,50	46,00	42,10	38,90
	40	M10x28	66,90	53,50	48,70	44,60	41,20
	45	M10x28	69,90	55,90	50,80	46,60	43,00
	50	M10x28	74,20	59,40	54,00	49,50	45,70
60	30	M12x37	77,20	61,70	56,10	51,40	47,50
	40	M12x37	78,00	62,40	56,70	52,00	48,00
70	35	M12x32	98,90	79,10	71,90	65,90	60,80
	45	M12x32	106,10	84,90	77,20	70,80	65,30
75	25	M12x37	134,80	107,80	98,00	89,80	82,90
	40	M12x37	158,80	123,70	115,50	105,80	97,70
	50	M12x37	177,70	142,20	129,30	118,50	109,40
	55	M12x37	188,40	150,70	137,00	125,60	115,90
100	30	M16x42	268,50	214,80	195,30	179,00	165,20
	40	M16x42	289,90	231,90	210,80	193,30	178,40
	50	M16x42	321,90	257,50	234,10	214,60	198,10
	55	M16x42	333,60	266,90	242,60	222,40	205,30
	60	M16x42	348,30	278,60	253,30	232,20	214,30
	75	M16x42	392,00	313,60	285,10	261,40	241,30
150	45	M16x42	717,20	573,70	521,60	478,10	441,30
	50	M16x42	755,10	604,10	549,20	503,40	464,70
	55	M16x42	784,30	627,50	570,40	522,90	482,70
	60	M16x42	846,40	655,50	596,00	546,30	504,30
75	M16x42	918,80	735,00	668,20	612,50	565,40	

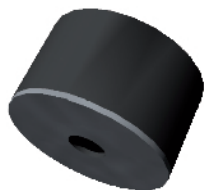
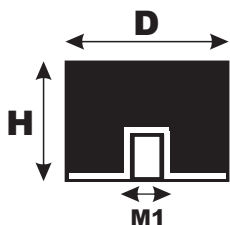

SILENTBLOKY - TYP E

JEDNOSTRANNÝ ZÁVIT VNITŘNÍ

D	H	M1	1 - 9 ks	10 - 24 ks	25 - 49 ks	50 - 99 ks	100 - 199 ks
15	8	M4	18,40	14,70	13,40	12,30	11,60
	10	M4	19,20	15,40	14,00	12,80	11,80
	15	M4	19,20	15,40	14,00	12,80	11,80
	20	M4	19,30	15,50	14,00	12,90	11,90
	30	M4	19,50	15,60	14,20	13,00	12,00
20	8	M6	24,70	19,70	17,90	16,40	15,20
	10	M6	24,90	19,90	18,10	16,60	15,30
	13,5	M6	25,20	20,20	18,30	16,80	15,50
	15	M6	25,50	20,40	18,50	17,00	15,70
	20	M6	26,40	21,10	19,20	17,60	16,20
	25	M6	26,90	21,50	19,60	18,00	16,60
	30	M6	27,50	22,00	20,00	18,30	16,90
25	10	M6	28,30	22,60	20,60	18,90	17,40
	15	M6	29,90	23,90	21,70	19,90	18,40
	20	M6	30,10	24,10	21,90	20,10	18,50
	25	M6	31,00	24,80	22,60	20,70	19,10
	30	M6	31,80	25,50	23,10	21,20	19,60
30	15	M6	31,20	25,20	23,50	22,10	19,80
	20	M6	33,50	26,80	24,40	22,30	20,60
	25	M6	35,00	28,00	25,50	23,30	21,50
	30	M6	36,50	29,20	26,50	24,30	22,40
	40	M6	39,40	31,50	28,70	26,30	24,30
40	20	M8	34,80	27,80	25,30	23,20	21,40
	30	M8	39,70	31,70	28,80	26,40	24,40
	40	M8	52,00	41,60	37,90	34,70	32,00
50	20	M10	59,40	47,50	43,20	39,60	35,70
	25	M10	62,40	49,90	45,40	41,60	38,40
	30	M10	66,70	53,40	48,50	44,50	41,00
	35	M10	70,20	56,20	51,10	46,80	43,20
	40	M10	74,10	59,30	53,90	49,40	46,00
	45	M10	76,90	61,50	56,00	51,30	47,30
	50	M10	81,40	65,10	59,20	54,20	50,10
60	30	M12	81,70	65,40	59,40	54,50	50,30
	40	M12	82,60	66,10	60,10	55,10	50,80
70	35	M12	103,40	81,50	75,20	68,90	63,60
	45	M12	110,80	88,60	80,60	73,90	68,20
75	25	M12	139,40	111,50	101,40	93,00	85,80
	40	M12	163,40	130,70	118,80	108,90	100,60
	50	M12	182,40	145,90	132,60	121,60	112,20
	55	M12	191,40	153,10	139,20	127,60	117,80
100	30	M16	270,70	216,50	196,90	180,50	166,60
	40	M16	291,90	233,50	212,30	194,60	179,70
	50	M16	324,10	259,30	235,70	216,10	199,40
	55	M16	335,80	268,60	244,20	223,90	206,60
	60	M16	350,60	280,30	254,80	233,60	215,60
	75	M16	394,20	315,40	286,70	262,80	242,60
150	45	M16	719,20	575,40	523,10	479,50	442,60
	50	M16	757,30	605,80	550,70	504,80	466,00
	55	M16	786,50	629,20	572,00	524,30	484,00
	60	M16	821,50	657,20	597,40	547,70	505,50
	75	M16	920,80	736,60	669,70	613,90	566,60

Šňůry jsou svými mechanickými, fyzikálními, chemickými vlastnostmi a trvalou deformací předurčené jako těsnění konstrukčních a stavebních částí v různých odvětvích průmyslu.

Nepropouští vzduch a nemají prakticky žádnou nasákavost. V rozmezí teplot dle použitého materiálu odolávají povětrnostním vlivům beze změny fyzikálních, mechanických a chemických vlastností.

Těsnící šňůry vyrábíme z následujících materiálů:

- pryže (EPDM, NBR, VITON, CR, SILIKON)
- mikroporézní pryže (CR, EPDM, NBR, SILIKON)
- další materiály dle poptávky

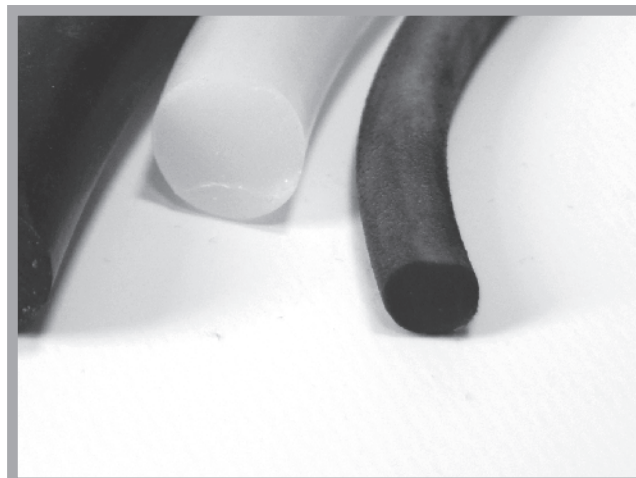
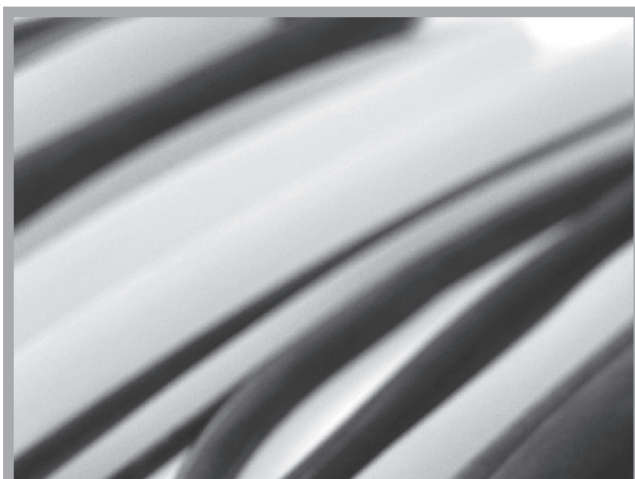

Silikon šňůry		Cena				
⊗ průměr	0,01 - 49,99 bm	50,00 - 99,99 bm	100,00 - 249,99 bm	250,00 - 499,99 bm	od 500,00 bm	
3 mm	7,08	5,31	3,54	3,54	3,04	
4 mm	9,96	7,97	7,24	6,64	5,69	
5 mm	15,27	12,22	11,11	10,18	8,73	
6 mm	17,53	15,94	14,61	13,49	12,52	
7 mm	18,59	16,90	15,49	14,30	13,28	
8 mm	20,19	18,35	16,82	15,53	14,42	
9 mm	25,50	23,18	21,25	19,62	18,21	
10 mm	28,49	26,12	24,11	22,39	20,90	
11 mm	34,29	31,43	29,01	26,94	25,15	
12 mm	37,63	34,74	32,25	30,10	28,22	
13 mm	43,83	40,46	37,57	35,06	32,87	
14 mm	50,91	47,00	43,64	40,73	38,18	
15 mm	58,44	53,94	50,09	46,75	43,83	
16 mm	66,85	61,71	57,30	53,48	50,14	

FPM šňůry		Cena			
⊗ průměr	0,01 - 24,99 bm	25,00 - 99,99 bm	100,00 - 199,99 bm	od 200,00 bm	
2 mm	19,81	18,28	16,98	15,85	
3 mm	35,53	32,79	30,46	28,42	
4 mm	59,14	54,60	50,70	47,32	
5 mm	89,23	82,36	76,48	71,39	
6 mm	120,67	111,39	103,43	96,55	
7 mm	160,08	147,77	137,21	128,07	
8 mm	207,25	191,31	177,64	165,81	
10 mm	321,33	296,61	275,42	257,06	
12 mm	397,49	366,91	340,70	317,99	
15 mm	620,73	572,98	532,05	496,58	

EPDM šňůry		Cena			
⊗ průměr	0,01 - 49,99 bm	50,00 - 99,99 bm	100,00 - 499,99 bm	od 500,00 bm	
2 mm	7,41	5,19	4,32	3,80	
3 mm	9,29	6,51	5,42	4,77	
4 mm	10,00	7,00	5,83	5,13	
5 mm	16,24	11,36	9,47	8,33	
6 mm	21,88	15,32	12,76	11,23	
7 mm	27,53	19,27	16,06	14,13	
8 mm	32,82	22,98	19,15	16,85	
9 mm	37,65	26,35	21,96	19,33	
10 mm	42,12	29,48	24,57	21,65	
12 mm	72,35	50,65	42,21	37,14	

ŠŇŮRY

SILIKON / FPM / EPDM / NBR / MIKROPORÉZNÍ



NBR šňůry		Cena			
⊗ průměr	0,01 - 49,99 bm	50,00 - 99,99 bm	100,00 - 499,99 bm	od 500,00 bm	
2 mm	7,41	5,19	4,32	3,80	
3 mm	9,29	6,51	5,42	4,77	
4 mm	10,00	7,00	5,83	5,13	
5 mm	16,24	11,36	9,47	8,33	
6 mm	21,88	15,32	12,76	11,23	
7 mm	27,53	19,27	16,06	14,13	
8 mm	32,82	22,98	19,15	16,85	
9 mm	37,65	26,35	21,96	19,33	
10 mm	42,12	29,48	24,57	21,65	
12 mm	72,35	50,65	42,21	37,14	

mikroporézní EPDM		Cena			
⊗ průměr	0,01 - 49,99 bm	50,00 - 99,99 bm	100,00 - 249,99 bm	od 250,00 bm	
2 mm	3,47	3,18	2,93	2,72	
3 mm	3,81	3,47	3,18	2,93	
4 mm	5,08	4,62	4,24	3,91	
5 mm	6,35	5,78	5,29	4,89	
6 mm	7,06	6,35	5,78	5,29	
7 mm	8,05	7,32	6,71	6,19	
8 mm	10,59	9,63	8,82	8,14	
9mm	13,13	11,94	10,94	10,10	
10 mm	16,52	15,05	13,76	12,71	
12 mm	21,18	19,25	17,65	16,29	
13mm	24,99	22,72	20,82	19,22	
14mm	28,80	26,18	24,00	22,15	
15 mm	33,04	30,03	27,53	25,41	
16mm	37,69	34,27	31,41	29,00	
17mm	42,78	38,89	35,65	32,90	
18mm	47,86	43,51	39,88	36,81	
20mm	58,87	53,52	49,06	45,29	
25mm	76,66	69,69	63,88	58,97	
30mm	110,54	100,49	92,12	85,03	
35mm	150,35	136,68	125,29	115,66	
40mm	196,52	178,65	163,76	151,17	
45mm	248,61	226,01	207,18	191,21	
50mm	307,06	279,14	255,88	236,20	

Hadice vyrábíme z různých materiálů i pro různá použití. Hydraulické hadice vyrábíme ze syntetické pryže, která je odolná vůči olejům a povětrnostním podmínkám.

Silikonové hadice se používají zejména v potravinářském a farmaceutickém průmyslu, např. pro dopravu mléka a alkoholu.

Zabýváme se i výrobou PVC hadic:

- zahradních zavlažovacích hadic v různém provedení
- jednoplášťových hadic pro nenáročné použití v průmyslu, zemědělství a domácnosti pro transport vzduchu a vody
- sacích hadic využívaných například v zemědělství, průmyslu apod.

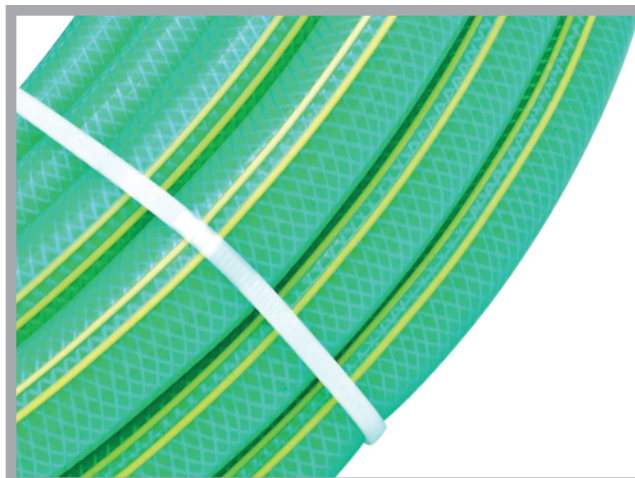
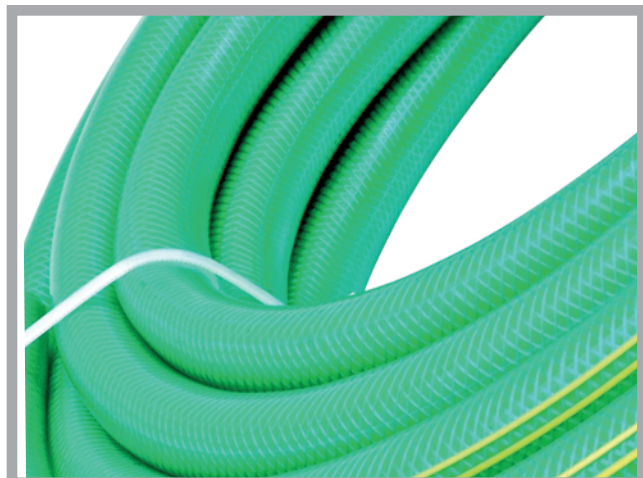
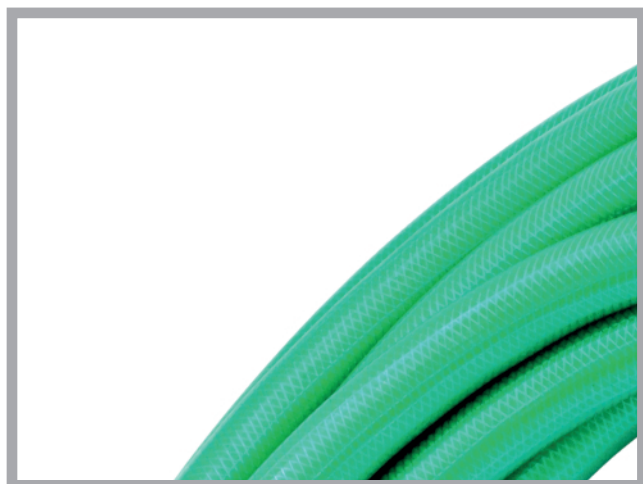

HADICE - ZAHRADNÍ



...těsně hned

PVC - ZAHRADNÍ HADICE

Materiál: Měkčené PVC, černá vnitřní vrstva, tmavě zelený obal se žlutým páskem.

Použití: Široce používaná hadice pro zavlažování, v průmyslu a v domácnostech pro vodu a vzduch. Lehká, pružná, elastická, přenosná a má výbornou přizpůsobivost.

Provozní teplota: -5 °C až +65 °C

Rozměr	⊘ vnitřní průměr	⊘ vnější průměr	balení	⌚ pracovní tlak	⌚ poruchový tlak	cena/bm
1/2"	12,7	17,1	25/50bm	10	32	10,90
5/8"	15,9	20,9	25/50bm	10	28	15,80
3/4"	19,0	25,6	25/50bm	10	25	22,00
1"	25,4	34,4	25/50bm	10	18	36,40



PVC - HADICE S TEXTILNÍM OPLETEM

Materiál: Měkčené PVC, čirá vnitřní vrstva, světlezelená nebo světlá venkovní vrstva (dle nabídky)

Použití: Tlaková hadice pro kapaliny a vzduch, používá se pro zavlažování, v zahradnictví, dopravu vody v průmyslu a zemědělství, domácnostech. Je flexibilní, odolná, netoxická, bez zápachu.

Provozní teplota: -5 °C až +65 °C

Rozměr	⊘ vnitřní průměr	⊘ vnější průměr	balení	⌚ pracovní tlak	⌚ poruchový tlak	cena/bm
5/16"	7,9	12,3	25/50bm	10	35	10,50
3/8"	9,5	13,9	25/50bm	10	32	10,60
1/2"	12,7	17,1	25/50bm	10	32	12,00
5/8"	15,9	20,9	25/50bm	10	28	21,30
3/4"	19,0	24,0	25/50bm	10	25	26,40
1"	25,4	32,0	25/50bm	10	18	37,50
5/4"	31,8	39,0	25/50bm	10	15	59,30

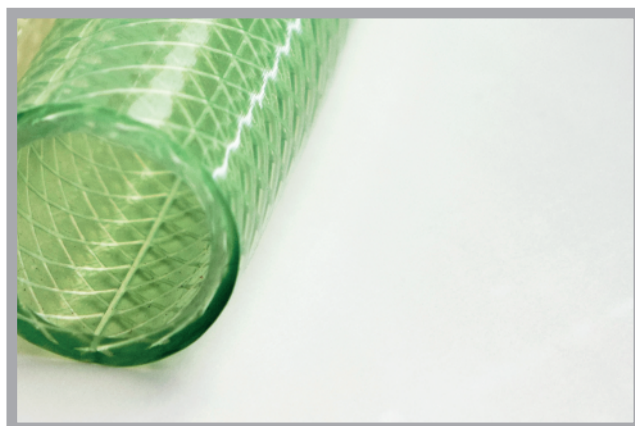
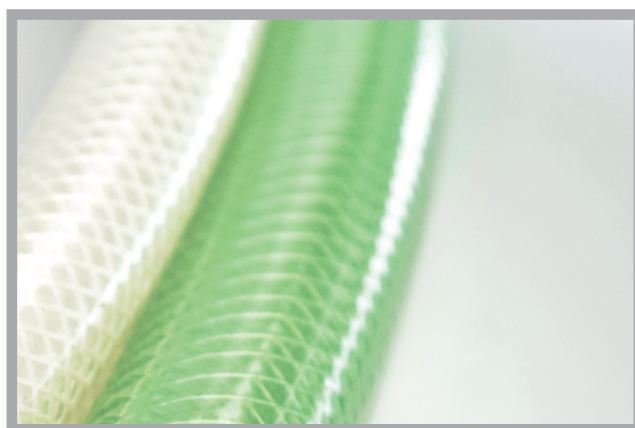

PVC - SACÍ HADICE S PLASTOVOU SPIRÁLOU

Materiál: Měkčené PVC, transparentně zelená

Použití: Určená pro sání a výtlač vody a jiných neagresivních kapalin. Používá se v průmyslu, zemědělství, zavlažování a stavebnictví. Je ideální alternativou pro gumové hadice a kovové trubky.

Provozní teplota: -5 °C až +65 °C

Rozměr	☉ vnitřní průměr	☉ vnější průměr	balení	🕒 pracovní tlak	🕒 poruchový tlak		cena/bm
3/4"	20	23,8	30bm	6	20	AV	19,80
1"	25	29,2	30bm	6	20	AV	23,90
1 1/4"	32	36,4	30bm	6	20	AV	28,80
1 1/2"	38	43,2	30bm	6	20	AV	43,10
2"	50	56	30bm	6	20	AV	64,40
3"	76	80,8	30bm	6	20	AV	128,90
4"	102	118	20bm	3	11	A	188,70
5"	125	140	20bm	3	11	A	290,60
6"	152	170	10bm	2	8	A	425,40
8"	203	225	10bm	2	8	A	590,80

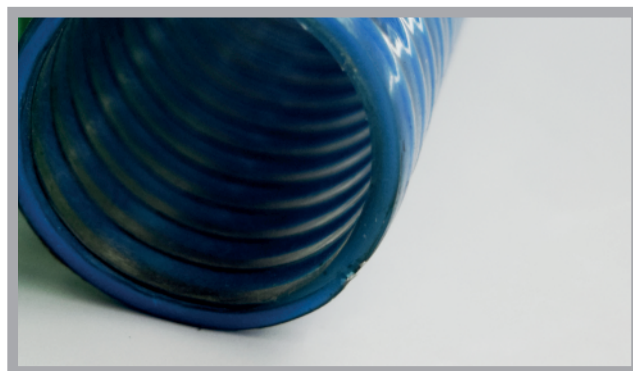
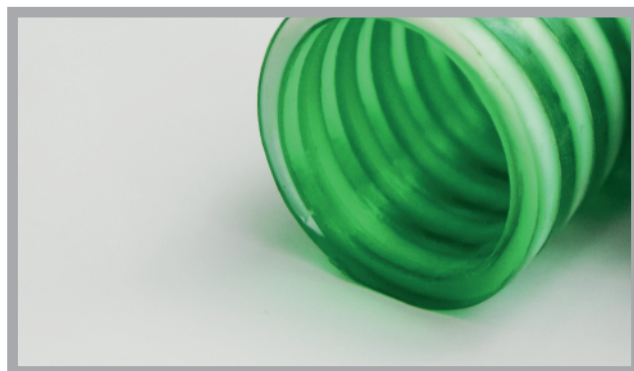
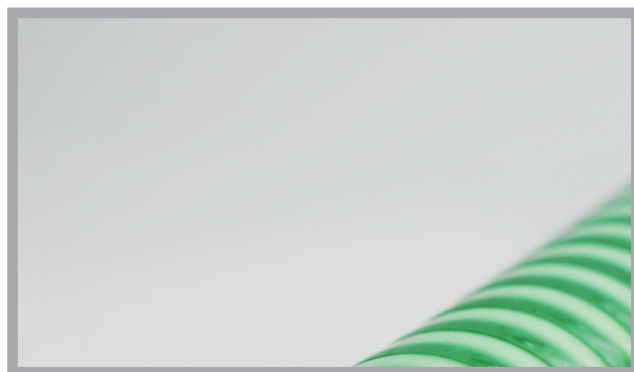

HADICE - S KOVOVOU SPIRÁLOU

PVC - HADICE S KOVOVOU SPIRÁLOU

Materiál: Měkčené PVC

Použití: Hadice je používána pro čerpání a dopravu vody, oleje a prachu v závodech, v zemědělství, strojírenství, potravinářství a kanalizačních potrubích. Hadice používaná pro potraviny je vyrobena ze speciálních materiálů. Je netoxická, lehká, bez zápachu a transparentní. Hadice může být používána pro přepravu mléka, nápojů, destilovaného alkoholu, piva, džemu a dalších materiálů. Můžeme také do hadice vložit měděný drát. Tato hadice může zabránit proudění statické elektriny a chrání uživatele před zasažením elektrickým proudem. Výrobek se používá pro dopravu kapalin, vody a vzduchu.

Provozní teplota: -5 °C až +65 °C

Rozměr	⊘ vnitřní průměr	⊘ vnější průměr	balení	⌚ pracovní tlak	⌚ poruchový tlak		cena/bm
3/8"	9	14	50bm	4	12	A	15,40
1/2"	12	17	50bm	4	12	A	17,40
5/8"	16	20	50bm	4	12	A	24,40
3/4"	19	25,6	50bm	4	9	A	26,20
1"	25	33	30bm	5	15	AV	26,40
1 1/4"	32	40,2	30bm	5	15	AV	37,50
1 1/2"	38	46,8	30bm	4	12	AV	59,30
2"	51	61,4	30bm	3	9	AV	98,90
3"	63	75	30bm	2	6	AV	197,10
4"	102	110	30bm	1,5	4,5	A	326,20
5"	125	141	20bm	1,5	4,5	A	477,30
6"	152	166	10bm	1,5	4,5	A	715,90
7"	180	196	10bm	1,5	4,5	A	805,70
8"	200	224	10bm	1,5	4,5	A	1.055,30



HADICE - JEDNOPLÁŠŤOVÁ



...těsní hned

PVC - HADICE JEDNOPLÁŠŤOVÁ

Materiál: Měkčené PVC, transparentní / čirá

Použití: Výrobek se používá pro dopravu kapalin, vody a vzduchu. Určená pro nenáročné použití v průmyslu, zemědělství a domácnosti. Je flexibilní, odolná, netoxická, bez zápachu.

Provozní teplota: -5 °C až +65 °C

⊘ vnitřní průměr	⊘ vnější průměr	balení	🕒 pracovní tlak	🕒 poruchový tlak		cena/bm
3	5	100bm	4	12	A	2,80
4	7	100bm	4	12	AV	6,20
5	8	100bm	4	12	AV	6,30
6	9	100bm	4	9	AV	6,40
7,9	10,9	100bm	5	15	AV	6,70
9,5	12,5	100bm	5	15	AV	8,20
12,5	15,9	50bm	4	12	AV	12,20
15,9	19,7	50bm	2	6	AV	15,95
19	23	50bm	1,5	4,5	AV	20,50
25,4	30,8	25bm	1,5	4,5	AV	34,50
34	36	40bm	1,5	4,5	A	36,20
38	43	40bm	1,5	4,5	A	39,20
51	57	40bm	1,5	4,5	A	68,80

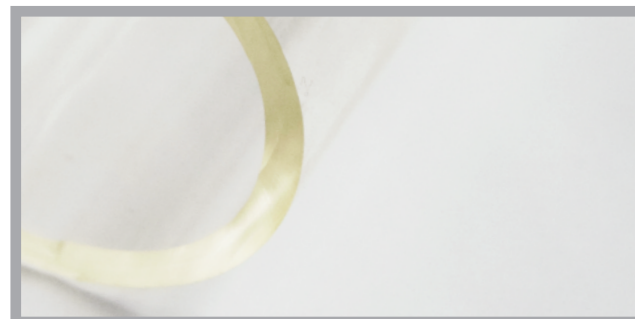
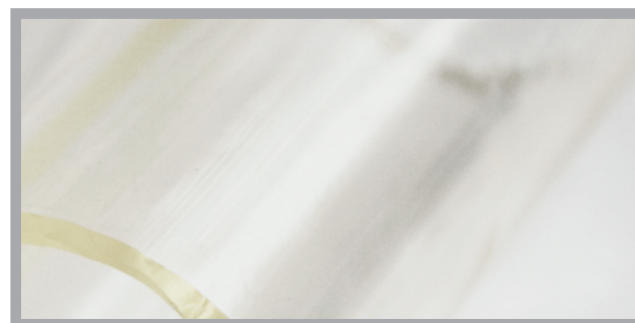



HADICE - SILIKON





Hadice - materiál silikon 60 +/- 5Sh., transp.

Rozměr	Cena				
	0,01 - 49,99 bm	50,00 - 99,99 bm	100,00 - 249,99 bm	250,00 - 499,99 bm	od 500,00 bm
1 x 1mm	4,60	3,70	3,10	2,70	2,50
2 x 1mm	7,30	5,80	4,90	4,20	3,90
3 x 1mm	10,00	8,00	6,60	5,70	5,30
4 x 1mm	12,00	9,60	8,00	6,80	6,40
5 x 1mm	16,60	11,70	9,70	8,30	7,80
6 x 1mm	17,30	13,80	11,50	9,90	9,20
7 x 1mm	19,30	15,40	12,80	11,00	10,30
8 x 1mm	21,90	17,50	14,60	12,50	11,70
9 x 1mm	24,60	19,70	16,40	14,00	13,10
10 x 1mm	17,30	13,80	11,50	9,90	9,20
11 x 1mm	19,30	15,40	12,80	11,00	10,30
12 x 1mm	20,60	16,50	13,70	11,80	11,00
Rozměr	0,01 - 49,99 bm	50,00 - 99,99 bm	100,00 - 249,99 bm	250,00 - 499,99 bm	od 500,00 bm
2 x 1,5mm	12,60	10,10	8,40	7,20	6,70
3 x 1,5mm	16,60	13,30	11,10	9,50	8,90
4 x 1,5mm	19,90	15,90	13,30	11,40	10,60
5 x 1,5mm	23,90	19,10	15,90	13,70	12,80
6 x 1,5mm	17,30	13,80	11,50	9,90	9,20
7 x 1,5mm	19,90	15,90	13,30	11,40	10,60
8 x 1,5mm	22,60	18,10	15,10	12,90	12,00
9 x 1,5mm	24,60	19,70	16,40	14,00	13,10
10 x 1,5mm	27,20	21,80	18,20	15,60	14,50
11 x 1,5mm	29,20	23,40	19,50	16,70	15,60
12 x 1,5mm	31,90	25,50	21,30	18,20	17,00
Rozměr	0,01 - 49,99 bm	50,00 - 99,99 bm	100,00 - 249,99 bm	250,00 - 499,99 bm	od 500,00 bm
2 x 2mm	12,60	10,10	8,40	7,20	6,70
3 x 2mm	15,90	12,80	10,60	9,10	8,50
4 x 2mm	18,60	14,90	12,40	10,60	9,90
5 x 2mm	21,90	17,50	14,60	12,50	11,70
6 x 2mm	25,20	20,20	16,80	14,40	13,50
7 x 2mm	27,90	22,30	18,60	15,90	14,90
8 x 2mm	31,20	25,00	20,80	17,80	16,60
9 x 2mm	34,50	27,60	23,00	19,70	18,40
10 x 2mm	37,90	30,30	25,20	21,60	20,20
11 x 2mm	40,50	32,40	27,00	23,10	21,60

HADICE



BŘÍTY NA RADLICE

Břity na radlice		Cena				
 Rozměr	 délka max. mm	0,1 - 39 bm	40 - 99 bm	100 - 199 bm	200 - 499 bm	od 500 bm
70x40 mm	10.000 mm	340,10	315,80	294,80	276,40	260,10
80x20 mm	10.000 mm	202,10	187,70	175,20	164,20	154,60
100x20 mm	10.000 mm	251,20	233,30	217,70	204,10	192,10
120x30 mm	10.000 mm	439,70	408,30	381,00	357,20	336,20
120x40 mm	10.000 mm	579,40	538,00	502,20	470,80	443,10
130x30 mm	10.000 mm	475,90	441,90	412,50	386,70	363,90
140x50 mm	10.000 mm	836,80	777,10	725,30	679,90	639,90
180x50 mm	10.000 mm	1.067,30	991,10	925,00	869,20	816,20
200x20 mm	10.000 mm	493,20	457,90	427,40	400,70	377,10
200x40 mm	10.000 mm	980,60	910,60	849,90	796,70	749,90
200x50 mm	10.000 mm	1.233,20	1.145,10	1.068,70	1.001,90	94,00
230x50 mm	10.000 mm	1.606,50	1.491,70	1.392,30	1.305,30	1.228,50
230x40 mm	10.000 mm	1.195,60	1.110,20	1.036,20	971,40	914,30
250x50 mm	10.000 mm	1.482,20	1.376,30	1.284,60	1.204,30	1.133,40
250x60 mm	10.000 mm	1.786,60	1.659,00	1.548,40	1.451,60	1.366,20

Materiál: SBR, 4x textilní vložka

Tvrдость: 70 +/-5 Sh.

Barva: černá

Tažnost: >400-500 %

Pevnost: 9-11 Mpa

Poznámka:

- oděruvzdorná pryž
- délka až 10.000 mm
- dle požadavků Vám dodáme břity s otvory
- řežeme délky na přání zákazníka

Jiné materiály dle konkrétní poptávky (PU, EPDM atd)

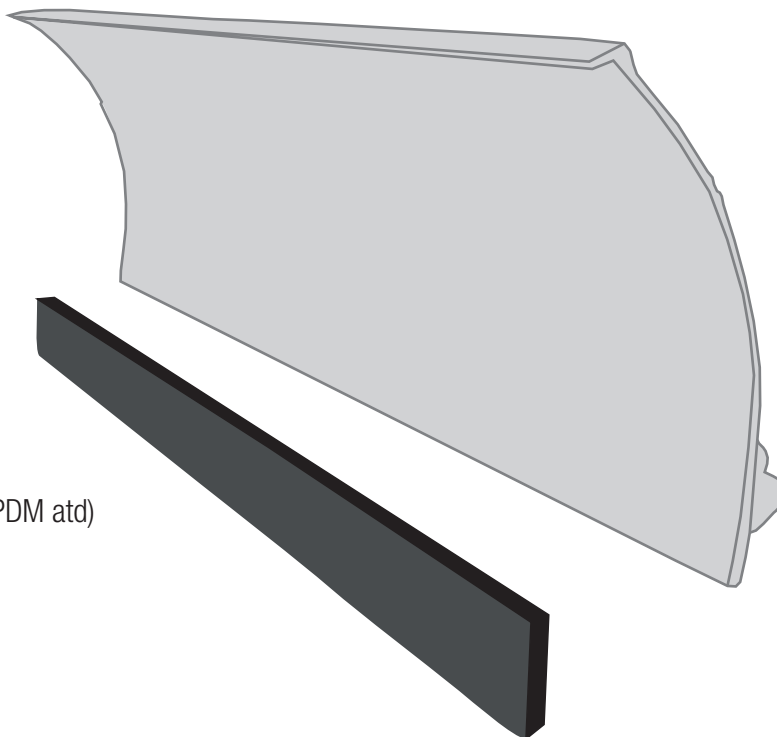

ZÁVĚSNÉ PVC PÁSY



Slouží jako průhledná clona pro oddělení skladových a výrobních prostor, garáží apod. Vhodné jsou zejména z důvodu bezpečnosti, hlukové nebo tepelné izolace a hygieny.

Pásky se musí vzájemně překrývat, aby zamezily průvanu nebo úniku tepla. Mají vysokou odolnost proti oděru.

Průhlednost plastových závěsů zlepšuje světelné poměry a snižuje náklady na osvětlení.

Materiál: měkčené transparentní PVC

Pracovní teplota: -20 °C / +60 °C

Závěsné PVC pásky	Cena			
	0,01 - 9,99 bm	10 - 29,99 bm	25 - 99,99 bm	nad 100 bm
100 x 2 mm	34,60	29,90	28,10	26,40
200 x 2 mm	66,80	57,90	54,30	51,10
300 x 2 mm	99,10	85,90	80,50	75,80
100 x 3 mm	55,40	48,00	45,00	42,40
200 x 3 mm	103,40	89,60	84,00	79,10
300 x 3 mm	154,00	133,50	125,10	117,80
400 x 3 mm	204,50	177,30	166,20	156,40

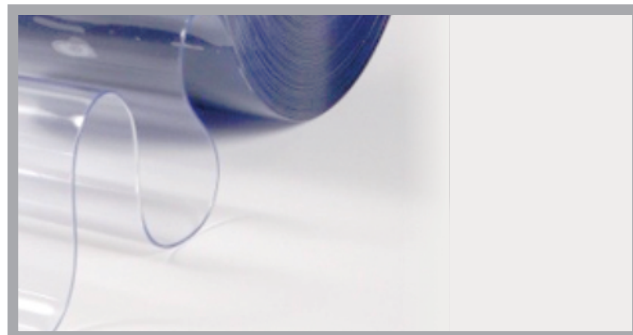
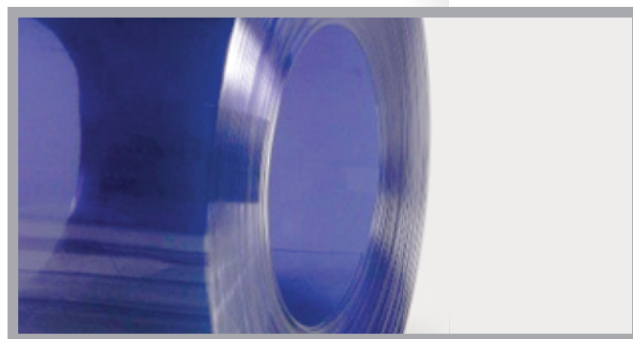

PODLOŽKY PRO ZVEDÁKY

Vyrábíme různé druhy podložek pro autoservisní a ruční zvedáky z kvalitní pryže, které minimalizují riziko poškození prahu vozidla.

Předností je vysoká životnost a pružnost.

Najdete u nás jak navlékáací podložky různých tvarů, tak i podložky se šrouby nebo gumovými trny.

navlékáací - Ø 115 mm



navlékáací čtvercová - 118 mm

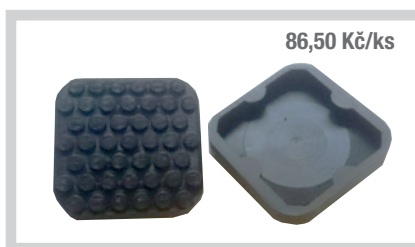

s otvory pro šroub M6 - Ø 125 mm



2x šroub M6 - Ø 110 mm



2x šroub M6 s prohloubením - Ø 110 mm



s gumovými trny a dírou - Ø 140 mm



se třemi gumovými trny - Ø 146 mm

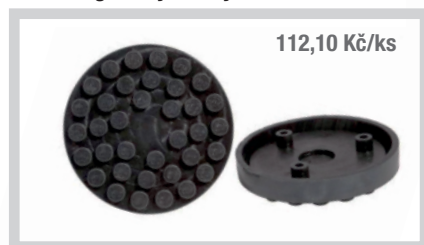

díra pro šroub 13mm - Ø 140 mm



malý zasazovací U profil - 120 mm



velký zasazovací U profil - 120 mm



HYDRAULICKÁ TĚSNĚNÍ



...těsní hned

Nabízíme na míru zhotovená těsnění pro hydraulické stroje.

Hydraulická těsnění vyrábíme na zakázku a jsme schopni poskytnout odborné poradenství a servis dle přání zákazníka.

- na míru zhotovená těsnění
- vlastní výroba
- rozsáhlé osobní poradenství a servis
- výroba na zakázku a speciální technická řešení

...těsní hned

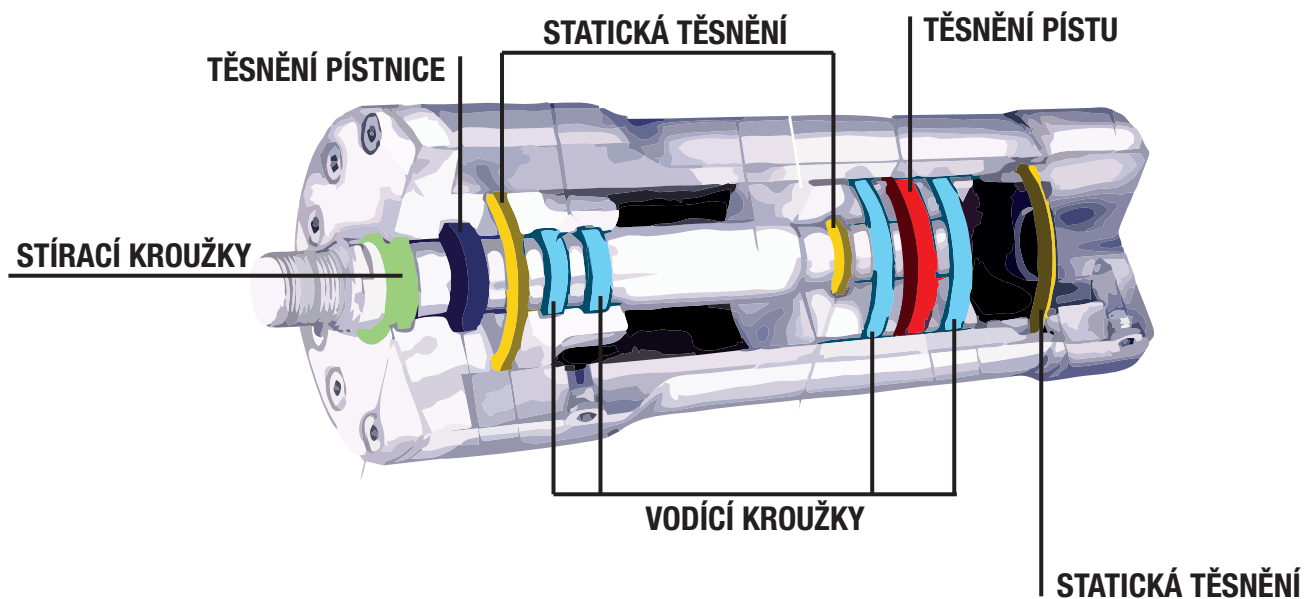

HYDRAULICKÁ TĚSNĚNÍ

STÍRACÍ KROUŽKY

Stírací kroužky jsou zabudovány v těsnících systémech válců, aby stíraly nečistotu, cizí částice, hobliny a vlhkost z pístní tyče, než zajede zpět do válce. To zabraňuje znečištění hydraulického média, které by mohlo poškodit vedení, těsnění a jiné komponenty.

FAKTORY PRO VÝBĚR GEOMETRIE STÍRACÍHO KROUŽKU

- pouze funkce stírání nebo stírání-těsnění
- druh znečištění z venkovní oblasti
- maximální rychlost pohybu (přímočarého nebo rotace)
- potřeba místa v konstrukčním prostoru
- otevřený nebo uzavřený prostor montáže
- min./max. teplotní rozsah
- přesné údaje o médiu (důležité pro výběr materiálu)

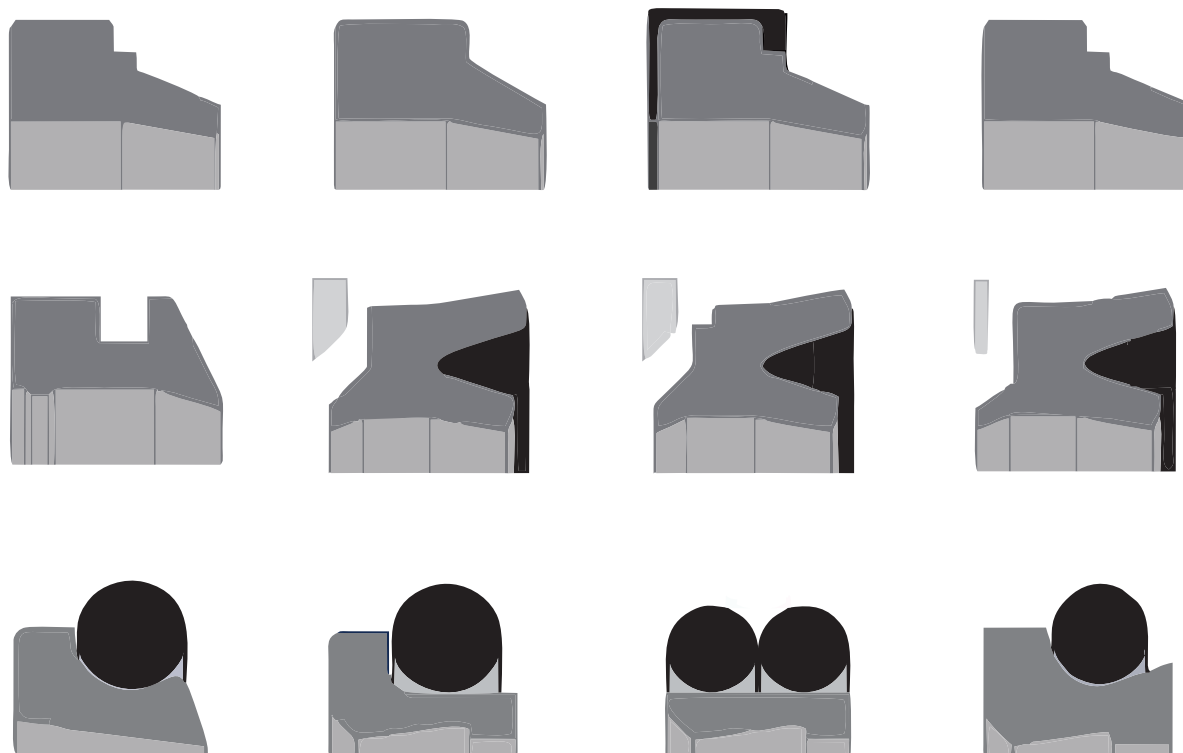

STÍRACÍ KROUŽKY VYRÁBÍME NA ZAKÁZKU. PRO VÍCE INFORMACÍ NÁS KONTAKTUJTE.

HYDRAULICKÁ TĚSNĚNÍ

TĚSNĚNÍ PÍSTNICE



Těsnění pístní tyče zaručuje těsnost systému směrem ven. Hlavní účinek těsnění se nachází na dynamické vnitřní straně těsnění. To udržuje prostor pístní tyče utěsněný a umožňuje natlakování při zajištění hydraulického nebo pneumatického válce. Bez těsnění pístní tyče by nefungoval žádný dvojitý hydraulický nebo pneumatický systém (výjimka: systémy s těsníci stahovači).

FAKTORY PRO VÝBĚR TĚSNĚNÍ PÍSTNÍ TYČE

- potřeba místa v konstrukčním prostoru
- rozsah použití systému
- maximální rychlost posuvu
- přesné údaje o rozměrech extruzní spáry
- maximální tlakové zatížení
- otevřený nebo uzavřený prostor montáže
- min./max. teplota
- přesné údaje o médiu (důležité pro výběr materiálu)

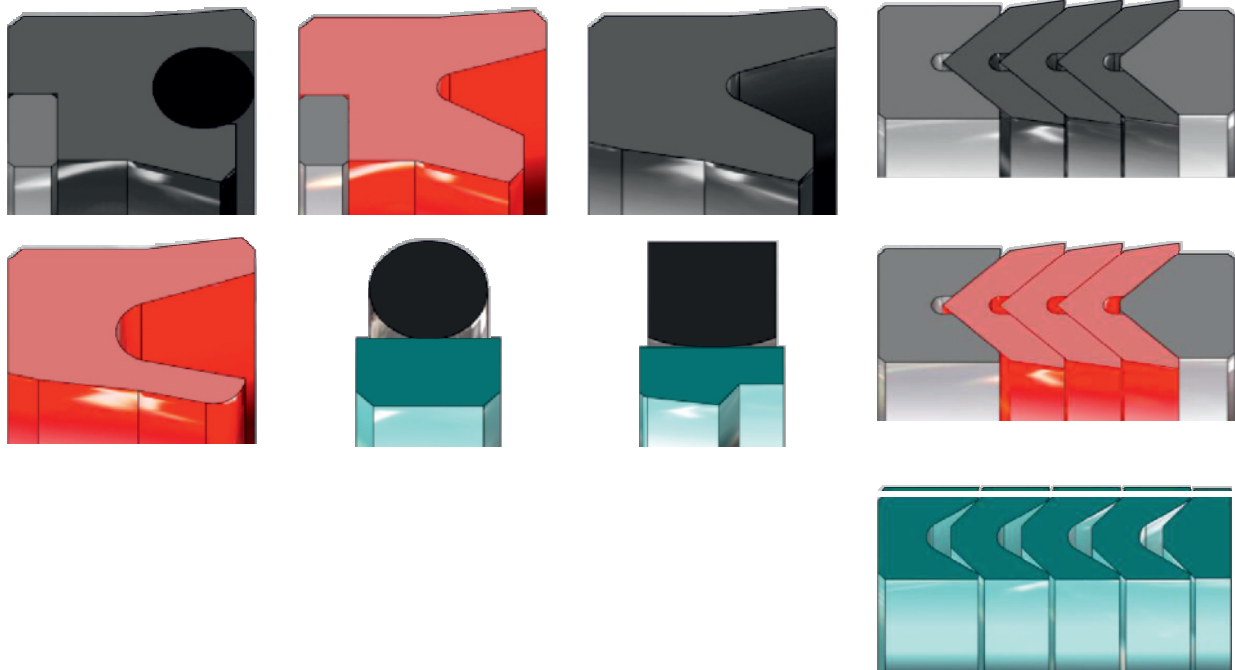

TĚSNĚNÍ PÍSTNICE VYRÁBÍME NA ZAKÁZKU. PRO VÍCE INFORMACÍ NÁS KONTAKTUJTE.

HYDRAULICKÁ TĚSNĚNÍ

VODÍCÍ KROUŽKY

Vodící kroužky mají funkci zabezpečení přesné souososti tyče pístu ve válci.
Jako vodící prvky jsou velmi důležitými konstrukčními částmi v kompletním těsnícím systému.

Bez přesného vedení by byla velmi zkrácena životnost těsnění tyče, popř. pístu.

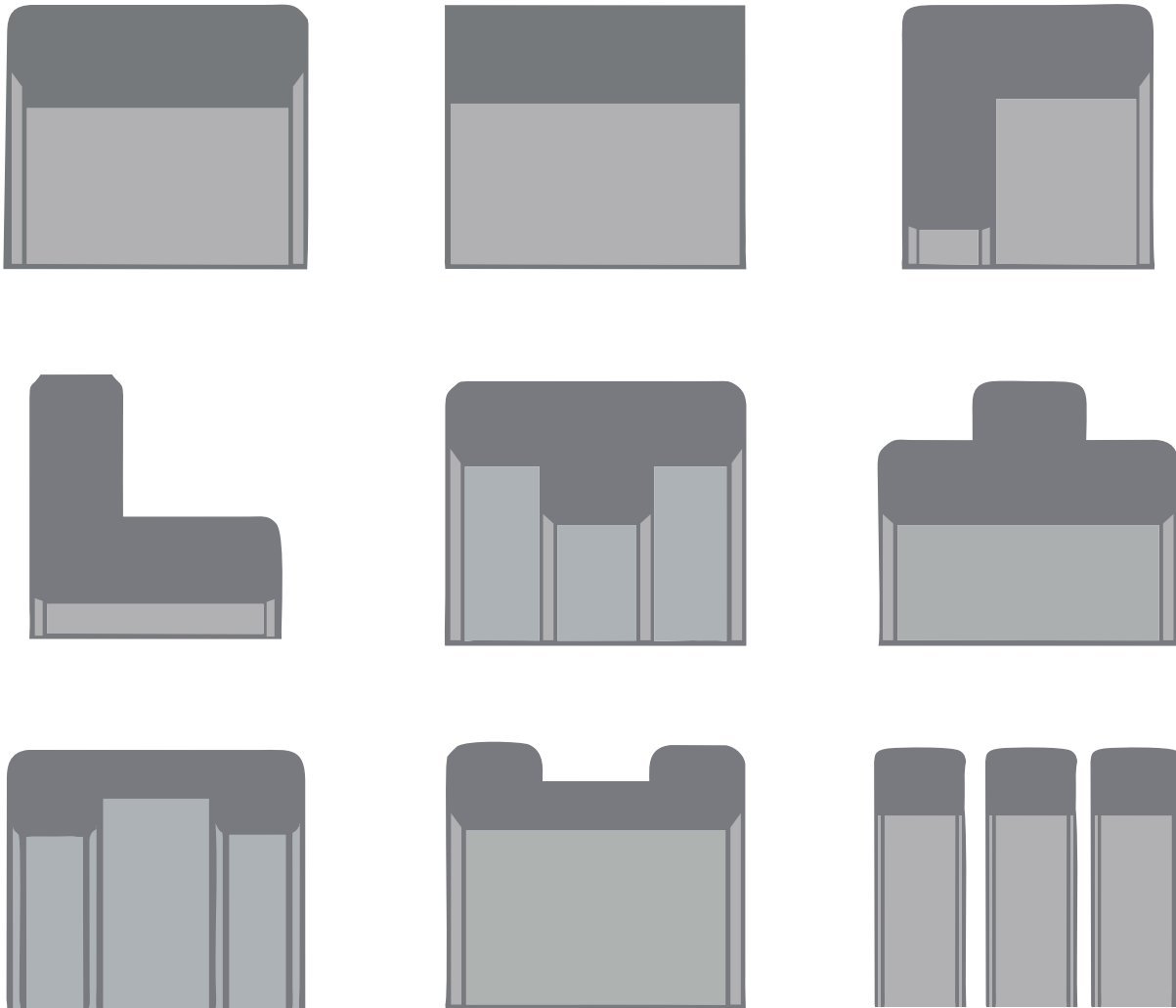

VODÍCÍ KROUŽKY VYRÁBÍME NA ZAKÁZKU. PRO VÍCE INFORMACÍ NÁS KONTAKTUJTE.

HYDRAULICKÁ TĚSNĚNÍ

TĚSNĚNÍ PÍSTU



Těsnění pístu zabezpečuje dynamické a statické utěsnění mezi pístem (vnějším průměrem) a trubicou válce.

FAKTORY PRO VÝBĚR TĚSNĚNÍ PÍSTU

- jednočinný nebo dvojitý těsnicí systém
- potřeba místa v konstrukčním prostoru
- rozsah použití systému
- maximální tlakové zatížení
- přesné údaje o rozměrech extruzní spáry
- maximální rychlost posuvu
- otevřený nebo uzavřený prostor montáže
- min./max. teplota
- přesné údaje o médiu (důležité pro výběr materiálu)

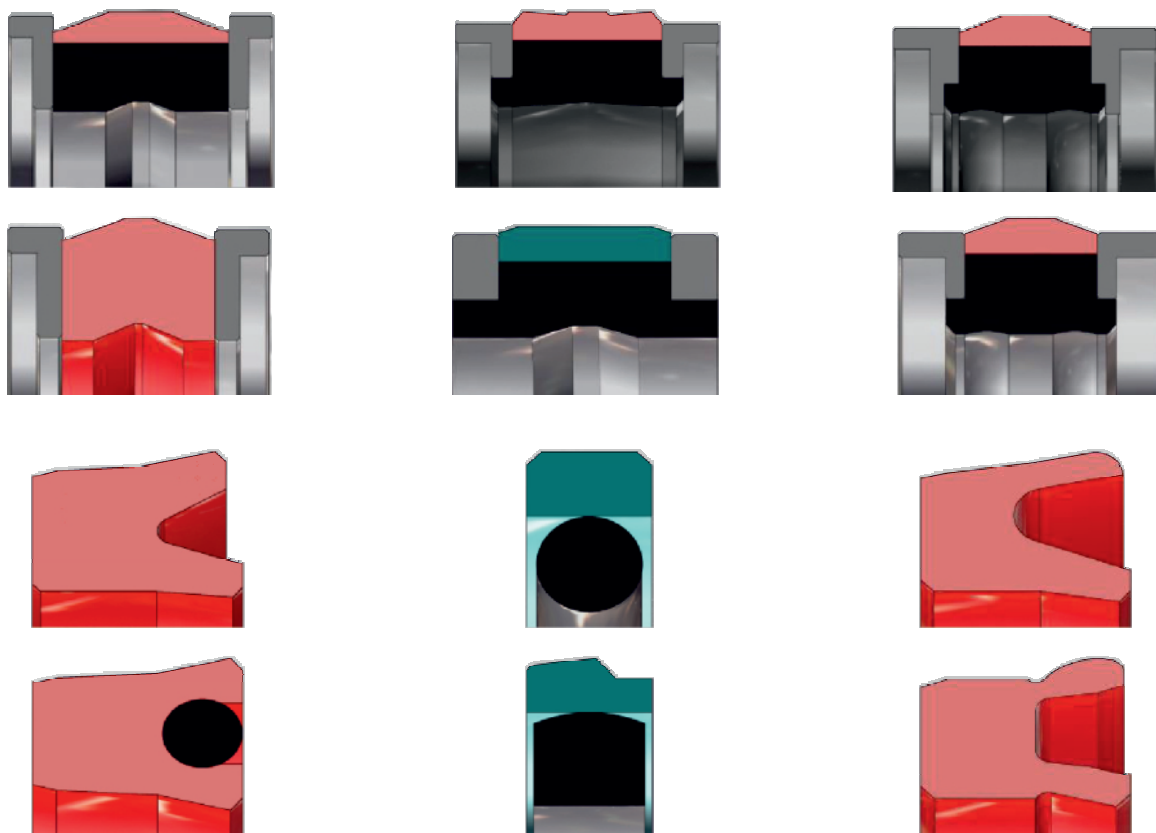

TĚSNĚNÍ PÍSTU VYRÁBÍME NA ZAKÁZKU. PRO VÍCE INFORMACÍ NÁS KONTAKTUJTE.

HYDRAULICKÁ TĚSNĚNÍ

STATICKÁ TĚSNĚNÍ

Statická těsnění se zpravidla používají pro statická utěsnění, například na vnitřní straně pístu nebo u šroubových spojů částí hlavy na trubku.

Prostřednictvím nabídky nejrůznějších geometrií mají konstruktéři v této oblasti širokou volbu dle potřeb dané aplikace.

Výběr geometrie statického těsnění vyplývá převážně z konstrukce systému.

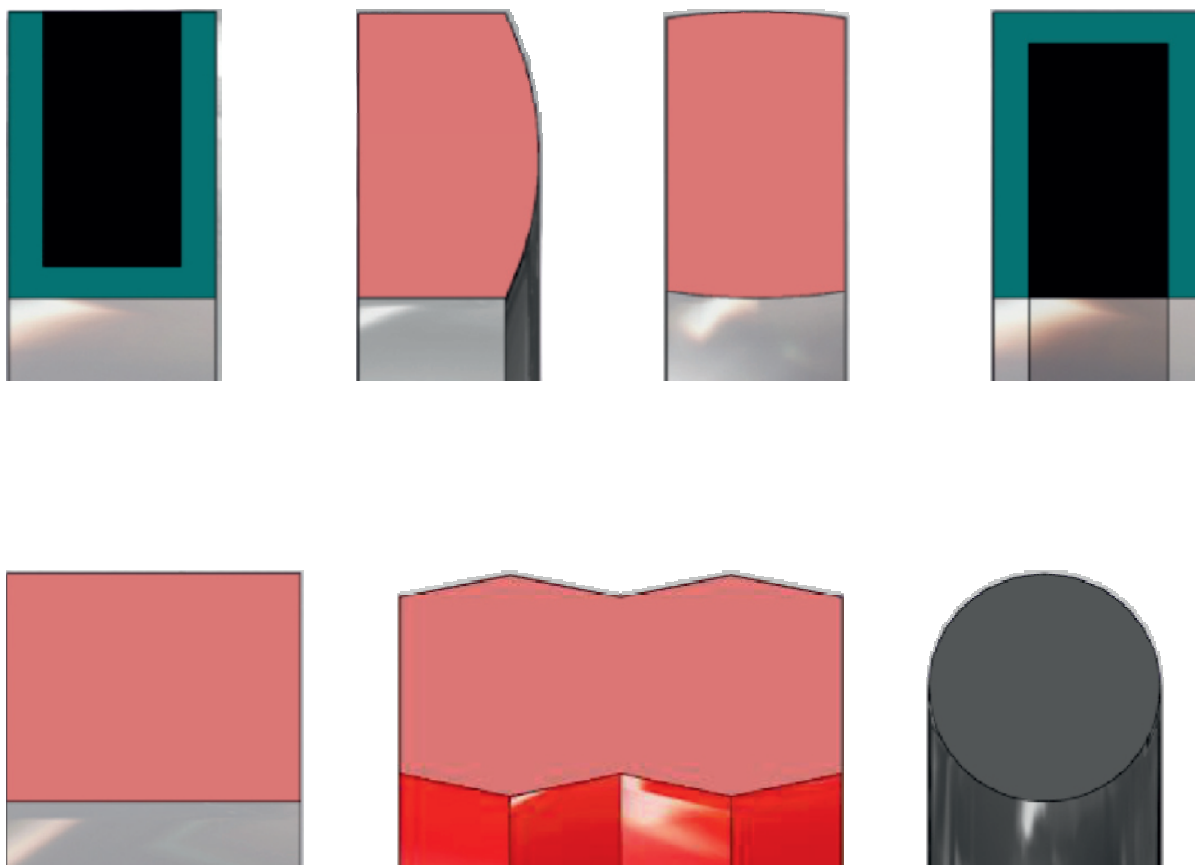

STATICKÁ TĚSNĚNÍ VYRÁBÍME NA ZAKÁZKU. PRO VÍCE INFORMACÍ NÁS KONTAKTUJTE.

HYDRAULICKÁ TĚSNĚNÍ

HŘÍDELOVÁ TĚSNĚNÍ



Těsnění hřídele zaručuje, aby rotující hřídel, která je z vnitřní strany zatěžována olejovou lázní, byla směrem ven utěsněna. To se zdá být na první pohled snadné, avšak po zvážení všech provozních podmínek zjistíme, že je to nejkomplicovanější.

FAKTORY PRO VÝBĚR TĚSNĚNÍ HŘÍDELE

- zatížení znečištěním v okolním prostoru
- potřeba místa
- otevřený nebo uzavřený prostor montáže
- maximální otáčky za minutu pro výpočet obvodové rychlosti
- provozní tlak nebo použití bez tlaku
- materiál, drsnost a tvrdost povrchu hřídele
- min./max. teplotní zatížení
- přesné údaje o médiu (důležité pro výběr materiálu)

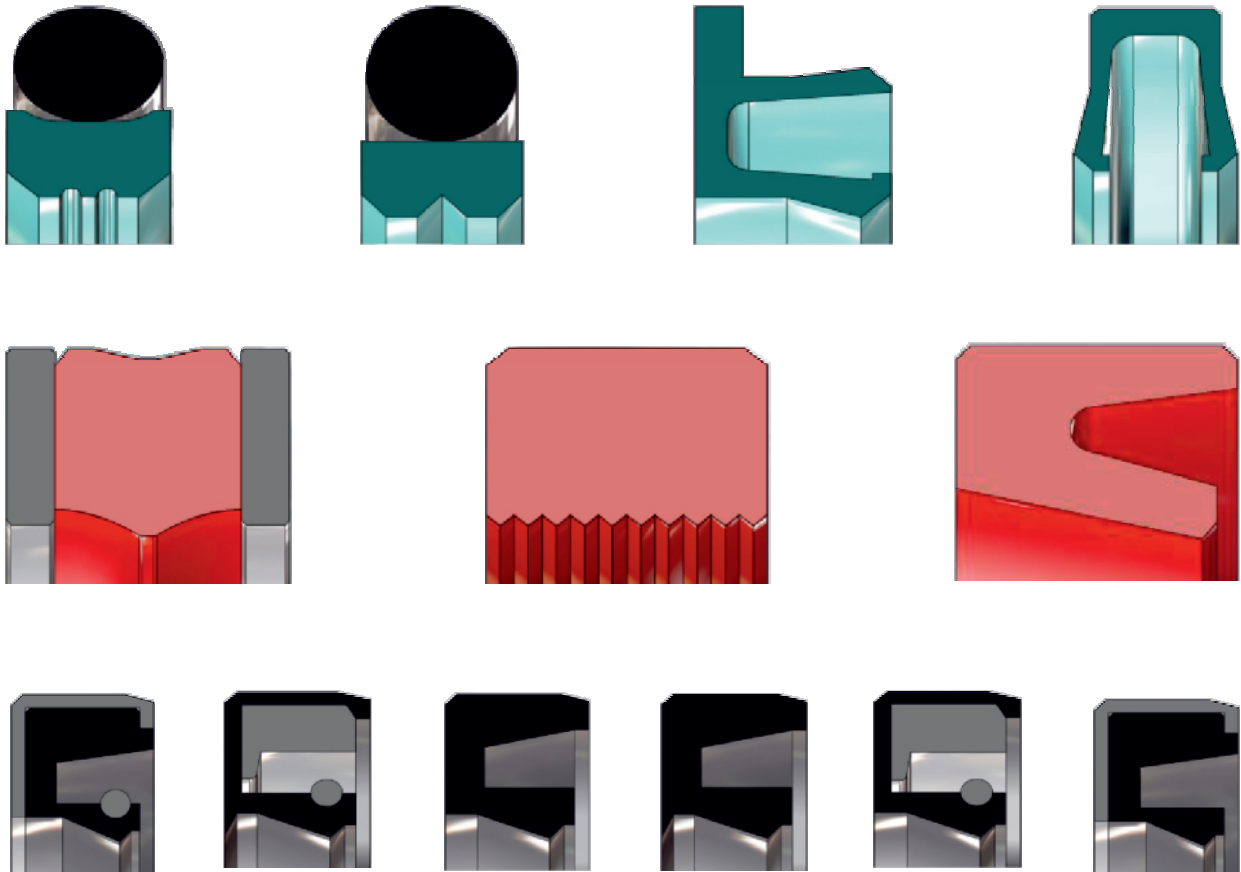

HYDRAULICKÁ TĚSNĚNÍ

OPĚRNÉ KROUŽKY

Opěrné kroužky se převážně používají k minimalizaci extruzní spáry, která vzniká na základě výroby nebo opotřebení kovových částí.

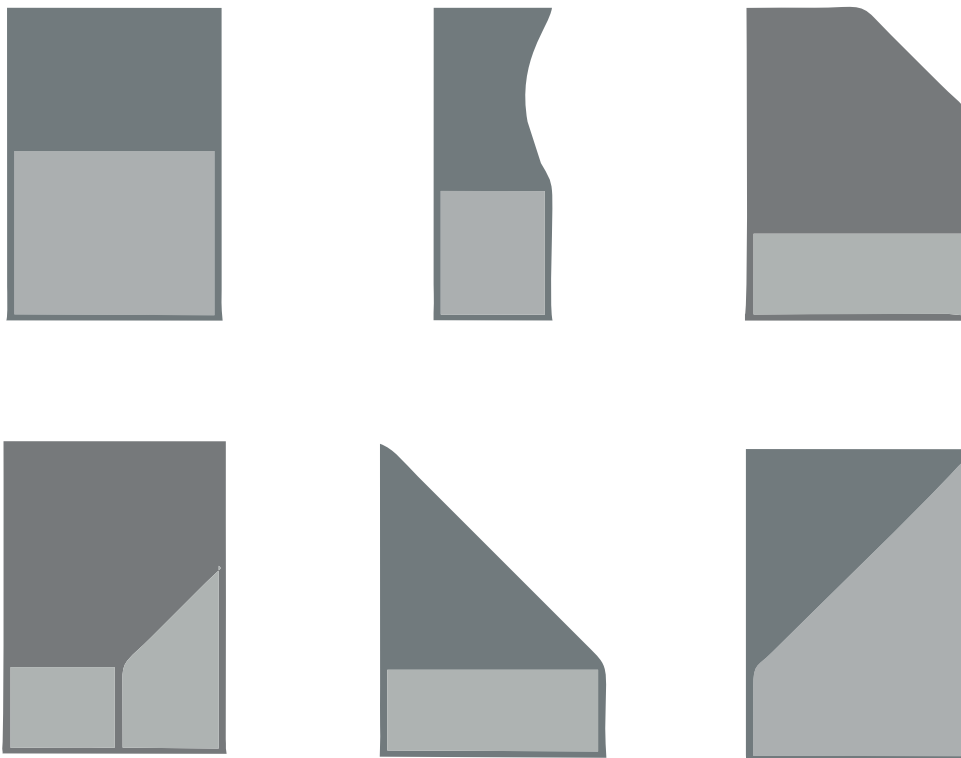

VODOVODNÍ TĚSNĚNÍ



...těsní hned

VODAŘSKÉ TĚSNÍCÍ KROUŽKY

MATERIÁL: **ADISEAL** (bezazbestové těsnící kroužky)

POUŽITÍ: voda, plyn, oleje, alkoholy, základní chemikálie

CERTIFIKACE: Germanischer Lloyd, KTW, tepl. 140 - 330°C

Vodárenské těsnící kroužky		Cena		
Rozměr	Rozměr vnější X vnitřní	ADISEAL BEZAZBEST tl. 1,6 mm / 140 °C	ADISEAL BEZAZBEST tl. 2,0 mm / 140 °C	ADISEAL BEZAZBEST tl. 2,0 mm / 330 °C
1/4"	24 x 17 mm	0,83	0,89	2,20
3/8"	27 x 19 mm	0,96	1,04	2,40
1/2"	34 x 24 mm	1,25	1,42	2,99
3/4"	38 x 27 mm	1,45	1,62	3,70
1"	44 x 34 mm	1,90	1,90	4,95
5/4"	56 x 44 mm	2,69	2,65	6,30
6/4"	62 x 47 mm	3,15	3,30	6,95
2"	78 x 60 mm	4,05	4,40	10,10
2 1/2"	96 x 75 mm	6,20	6,80	14,85
3"	110 x 85 mm	7,80	8,50	16,95

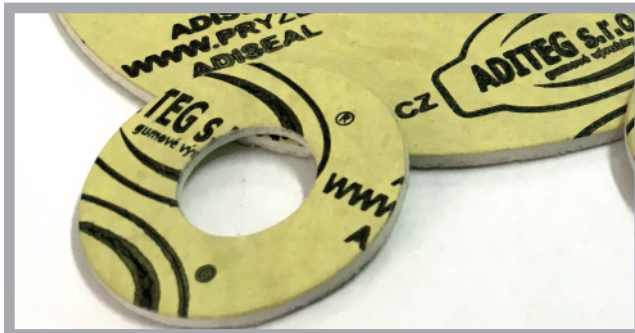
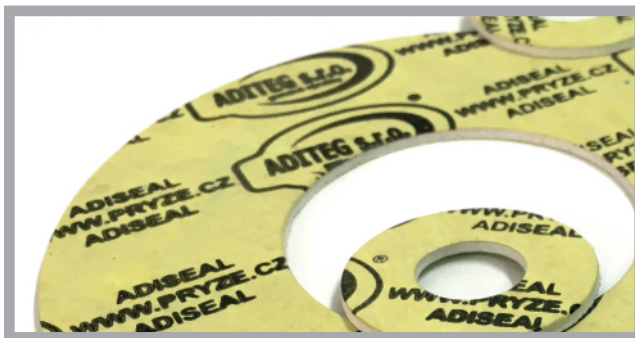

VODAŘSKÉ TĚSNÍCÍ KROUŽKY

MATERIÁL:

SBR - 65 +/-5 Sh, černá, 2-3 Mpa

- teplota -30°C až +80°C

SBR - FDA - teplota 65 +/- Sh. A, světlá, 5 Mpa

- teplota -30°C až +80°C

- potravinářská deska - FDA

Potravinářské desky se skládají ze surovin, které jsou schváleny FDA normou, listina 21, část 170-199, revidovanou od 1. dubna 1998.

Vodárenské těsnící kroužky		Cena		
Rozměr	Rozměr vnější X vnitřní	PRYŽ / SBR tl. 2 mm 2 - 3 MPa - do 80 °C	PRYŽ / SBR tl. 3 mm 2 - 3 MPa - do 80 °C	PRYŽ - potravinářská tl. 2 mm 5 MPa - do 80 °C
1/4"	24 x 17 mm	0,61	0,65	0,87
3/8"	27 x 19 mm	0,69	0,74	0,98
1/2"	34 x 24 mm	0,89	0,96	1,32
3/4"	38 x 27 mm	0,97	1,06	1,52
1"	44 x 34 mm	1,10	1,20	1,95
5/4"	56 x 44 mm	1,35	1,50	2,78
6/4"	62 x 47 mm	1,65	1,70	3,21
2"	78 x 60 mm	1,99	2,40	4,59
2 1/2"	96 x 75 mm	2,40	3,20	6,40
3"	110 x 85 mm	2,85	4,35	7,99

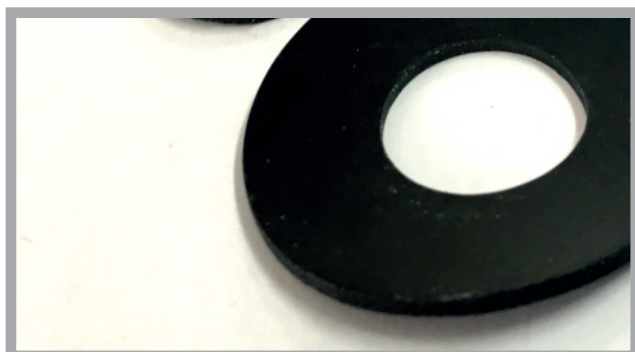
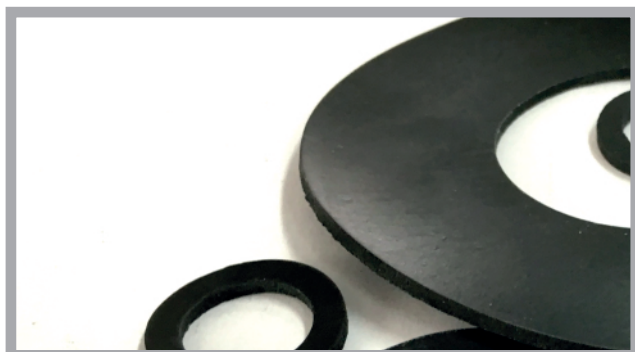

VYSEKÁVANÉ VÝROBKY



...těsní hned

Požadovaná těsnění a výseky vyrábíme z nejrůznějších materiálů:

- běžné pryže
- samolepící pryže
- plastických a izolačních hmot
- materiálů pro vysokotlaké použití
- fólií

Podle požadavků zákazníka dodáváme těsnění i z jiných materiálů.

Nabízíme vysekávané kroužky s dírami i bez, těsnění dle výkresů nebo vzorů, pásy, podložky, přířezy a ostatní těsnění. Maximální rozměr a tloušťka těsnění je dána dostupností používaných materiálů.



LISOVANÉ VÝROBKY

Největším podílem výrobků je použití v automobilovém a strojírenském odvětví.

Do této skupiny patří převážně:

O-kroužky, membrány, ucpávky, manžety, dorazy, gumové výrobky, kombinované s kovem (silentbloky) nebo jen pogumované.

Používané materiály jsou od nejběžnějších jako je NR či SBR před EPDM, NBR, CR až po silikon a fluorohochčík, v tvrdostech 30-90°C.

Toto široké spektrum kaučukových směsí nám umožňuje uspokojit veškeré nároky kladené na pryžové výrobky jako je odolávání oleji, ozonu, teplotě, tlaku, otěru, chemickému působení apod.

Výběr materiálu je možný dle mechanických a chemických podmínek pracovního prostředí.



O - KROUŽKY



...těsní hned

O-kroužky jsou těsnicí prvky kruhového průřezu, které svými těsníci vlastnostmi zabraňují nežádoucí ztrátě kapalin nebo plynů. Těsnícího účinku se dosahuje stlačením kruhového profilu kroužku, opřenému v drážce.

O-kroužky se používají v rozebíratelných spojích k těsnění jak nepohyblivých dílů (víka, příruby, šroubení), tak pohyblivých dílů v hydraulice a pneumatice (písty, pístnice).

O-kroužky mají všestranné využití, protože jsou jednoduché, těsní oboustranně, nevyžadují velký zástavbový prostor a snadno se montují. Pro danou výrobu používáme jak běžné materiály, tak i materiály na přání zákazníka. Existují stovky rozměrů z různých materiálů, jejich použití konzultujte přímo s našimi pracovníky.

Profily jsou svými mechanickými, fyzikálními, chemickými vlastnosti a trvalou deformací předurčené jako těsnění konstrukčních a stavebních částí v různých odvětvích průmyslu.

Nepropouští vzduch a nemají prakticky žádnou nasákavost.

V rozmezí teplot dle použitého materiálu odolávají povětrnostním vlivům beze změny fyzikálních, mechanických a chemických vlastností. Profily se vyrábějí jak v základních tvarech, tak i ve tvarech speciálních.

V závislosti na požadavku zákazníka zhotovíme profily dle předložených výkresů.

Základními materiály profilů jsou pryže (EPDM, NBR, VITON, CR, SILIKON) a mikroporézní pryže (CR, EPDM, SILIKON).

Další materiály dle poptávky.



PROFILY SILIKONOVÉ - ČTVERCOVÉ / OBDÉLNÍKOVÉ

Surová váha:	1,1 - 1,24g/cm ³
Ozon-UV / stárnutí	výborná
Shore A:	60 +/- 5
Barva:	bílá
Teplota	-60 stupňů Celsia, +200 stupňů Celsia
Krátkodobá teplota:	+230 stupňů Celsia
Tažnost při přetržení	> 350%
Pevnost v tahu DIN 53504	> 7 MPa

Profily čtvercové / obdélníkové - silikon 60 +/- 5Sh., bílá

Rozměr		Cena				
mm	mm	1,0 - 9,9 bm	10,0 - 24,9 bm	25,0 - 49,9 bm	50,0 - 99,9 bm	od 100,0 bm
3	6	13,80	11,80	10,30	8,30	6,90
3	10	22,90	19,70	17,20	13,80	11,50
3	20	45,90	39,30	34,40	27,50	22,90
3	25	57,40	49,20	43,00	34,40	28,70
4	6	18,40	15,70	13,80	11,00	9,20
4	8	24,50	21,00	18,40	14,70	12,20
5	5	19,10	16,40	14,30	11,50	9,60
5	10	38,20	32,80	28,70	22,90	19,10
5	15	57,40	49,20	43,00	34,40	28,70
5	20	76,50	65,50	57,40	45,90	38,20
5	25	95,60	81,90	71,70	57,40	47,80
6	6	27,20	23,60	20,60	16,50	13,80
6	8	36,70	31,50	27,50	22,00	18,40
6	10	45,0	39,30	34,40	27,50	22,90
6	15	68,80	59,00	51,60	41,30	34,40
8	8	48,90	41,90	36,70	29,40	24,50
8	11	67,30	57,70	50,50	40,40	33,60
8	15	91,80	78,70	68,80	55,10	45,90
8	20	122,40	104,90	91,80	73,40	61,20
10	10	76,50	65,50	57,40	45,90	38,20
10	12	91,80	78,70	68,80	55,10	45,90
10	15	114,70	98,30	86,00	68,80	57,40
10	20	152,90	131,10	114,70	91,80	76,50
10	30	229,40	196,60	172,10	137,60	114,70
12	12	11,10	94,40	82,60	66,10	55,10
12	20	183,50	157,30	137,60	110,10	91,80
14	14	149,90	128,50	112,40	89,90	74,90
15	15	172,10	147,50	129,00	103,20	86,00
15	20	229,40	196,60	172,10	137,60	114,70
15	25	286,80	245,80	215,10	172,10	143,40
15	30	344,10	295,00	258,10	206,50	172,10
20	20	305,90	262,20	229,40	183,50	152,90
20	30	458,80	393,30	344,10	275,30	229,40
25	25	477,90	409,70	358,50	286,80	239,00
30	30	688,20	589,90	516,20	412,90	344,10

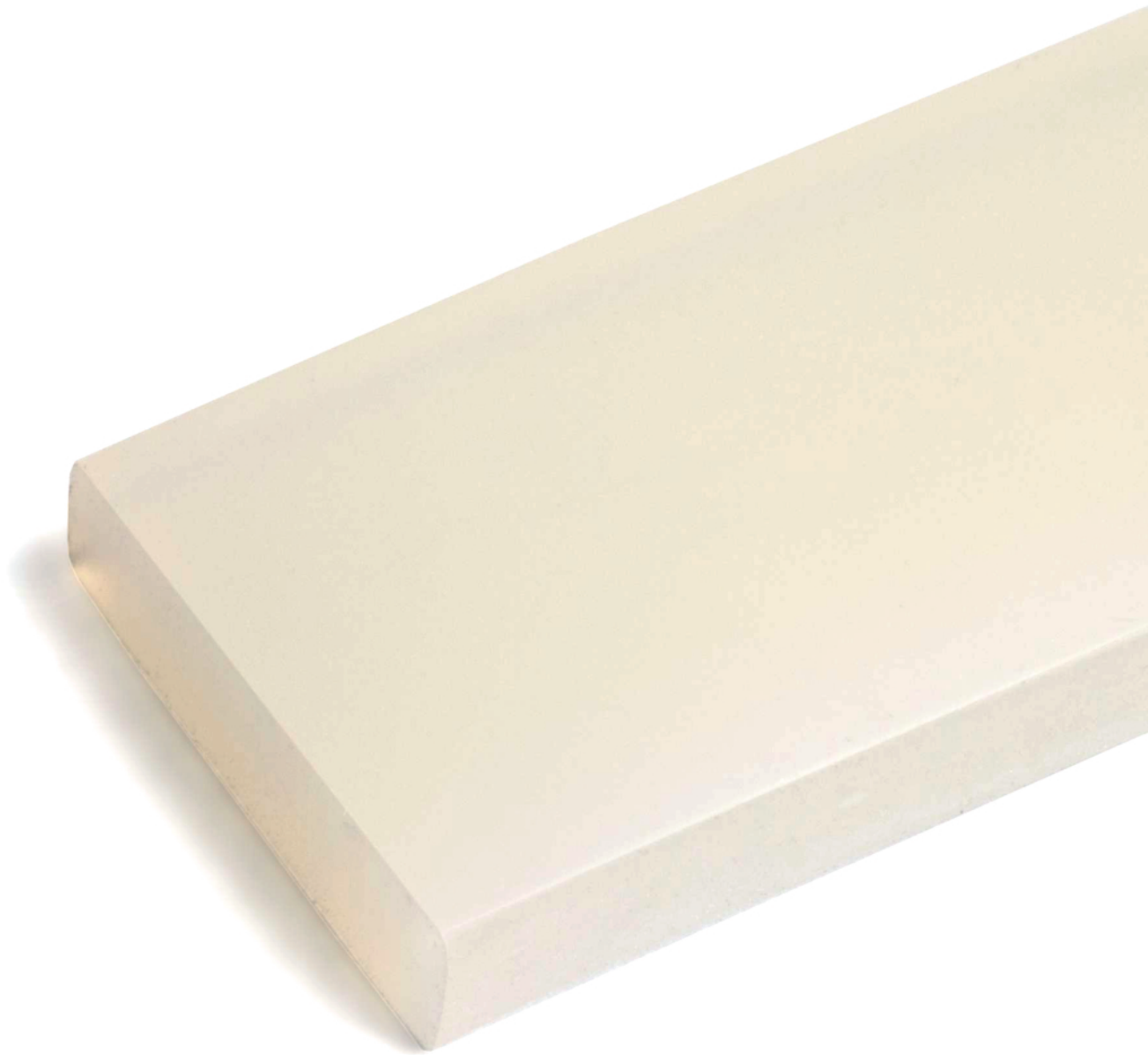

PROFILY

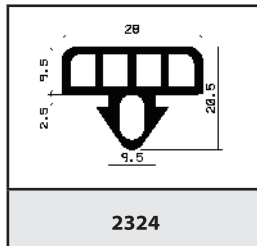
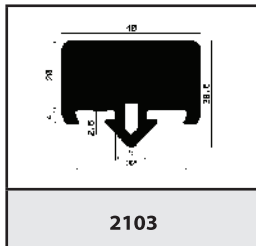
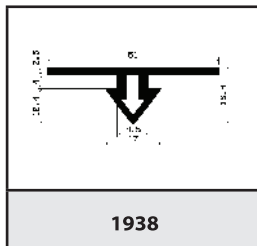
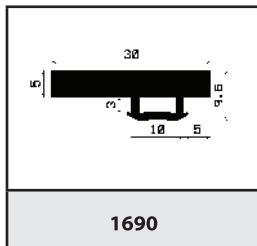
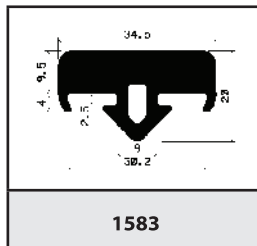
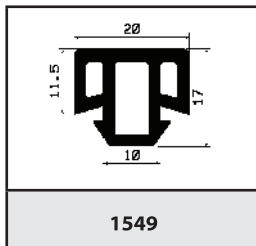
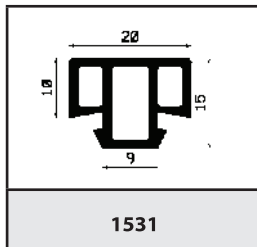
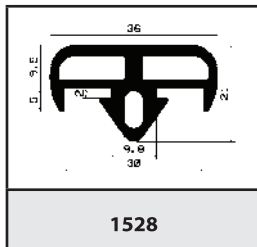
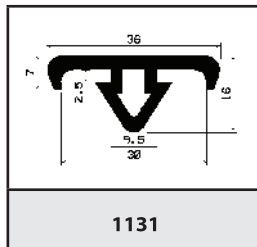
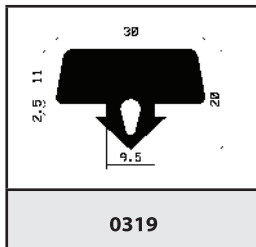
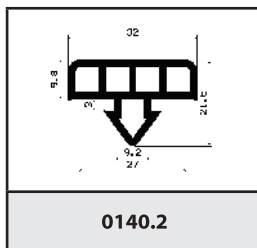
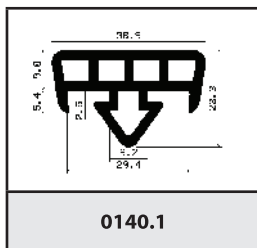
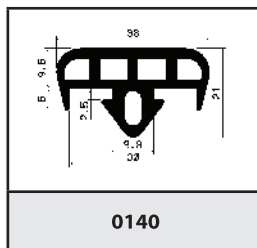
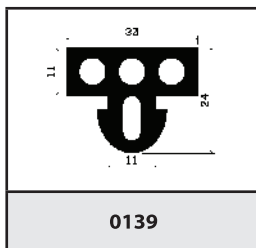

○ mikroporézní, mikroporézní/silikonové ● gumové, silikonové

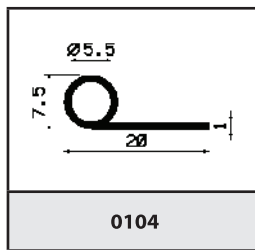

0104

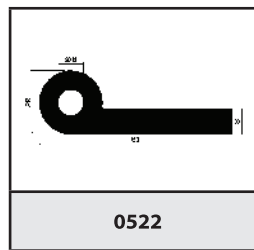

0522

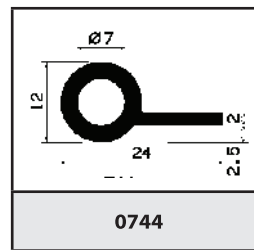

0744

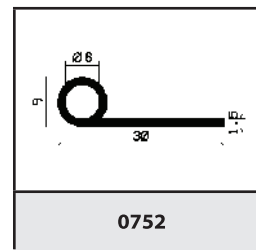

0752

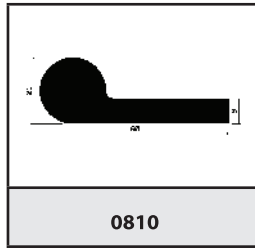

0810

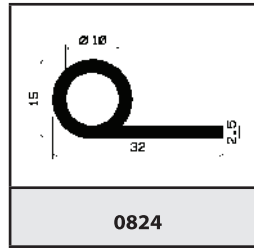

0824

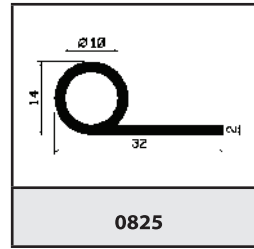

0825

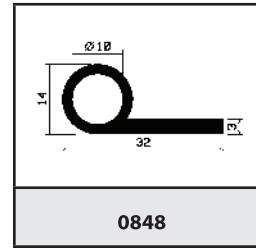

0848

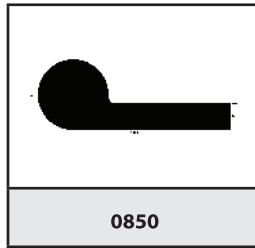

0850

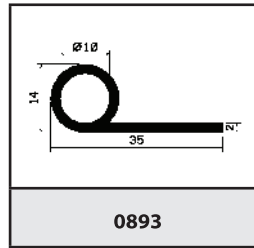

0893

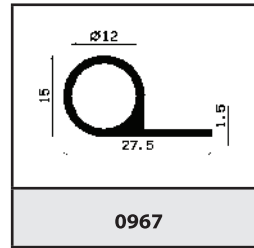

0967

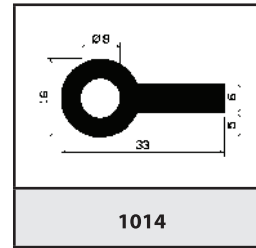

1014

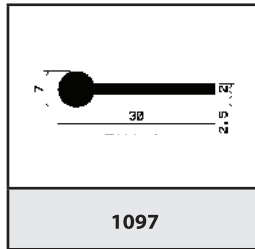

1097

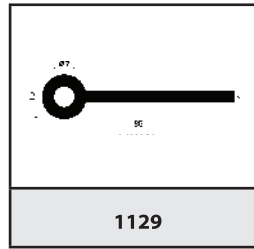

1129

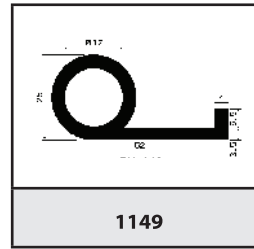

1149

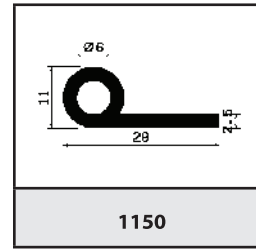

1150

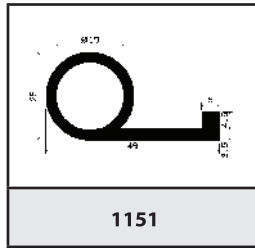

1151

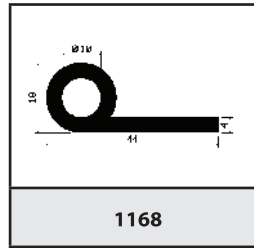

1168

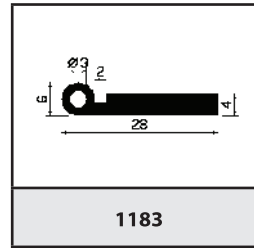

1183

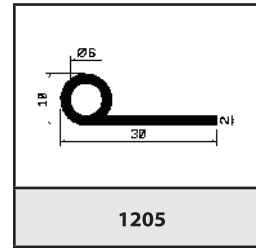

1205

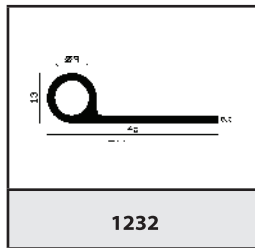

1232

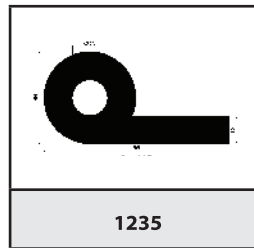

1235

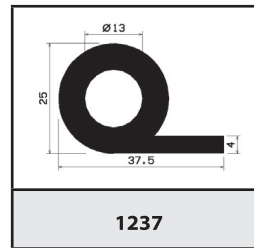

1237

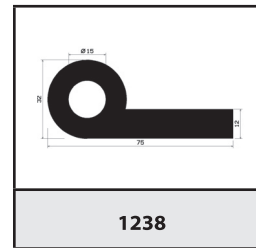

1238

○ mikroporézní, mikroporézní/silikonové ● gumové, silikonové

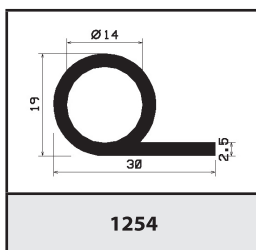

1254

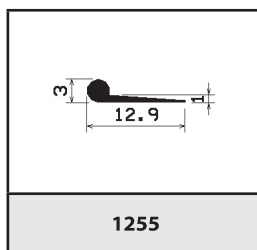

1255

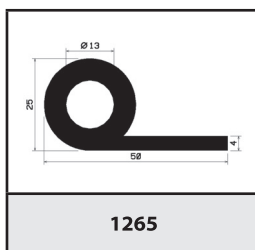

1265

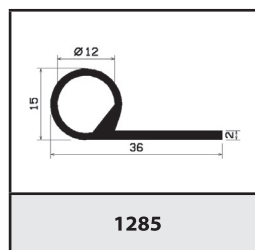

1285

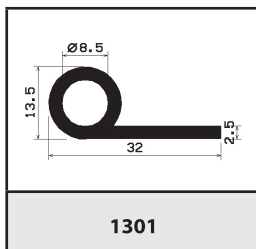

1301

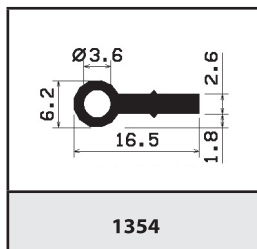

1354

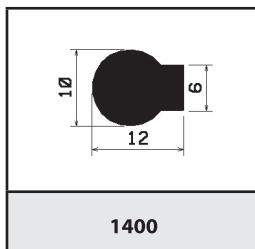

1400

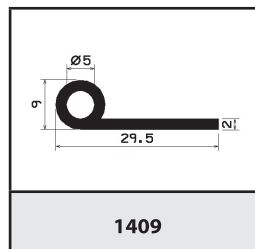

1409

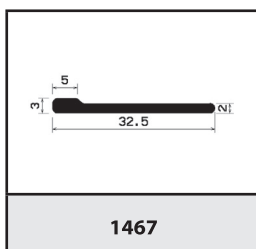

1467

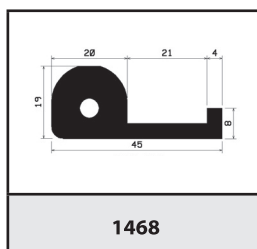

1468

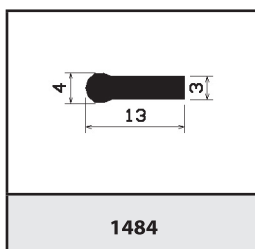

1484

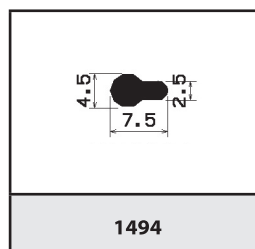

1494

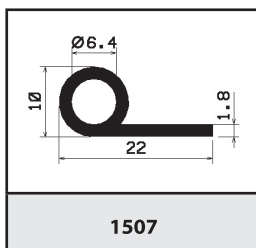

1507

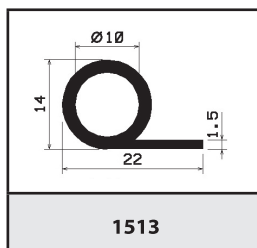

1513

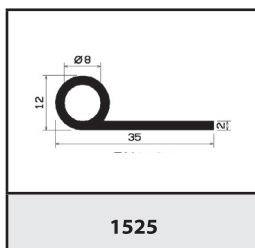

1525

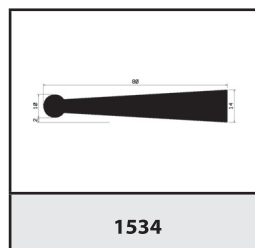

1534

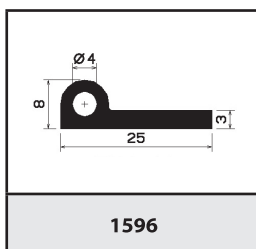

1596

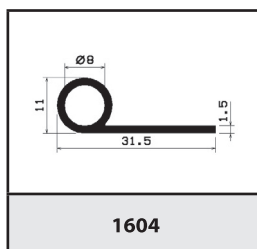

1604

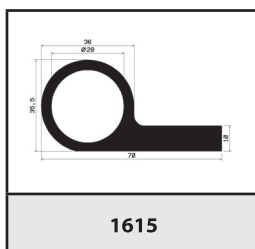

1615

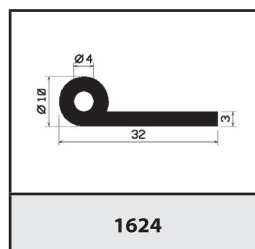

1624

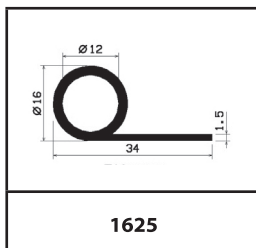

1625

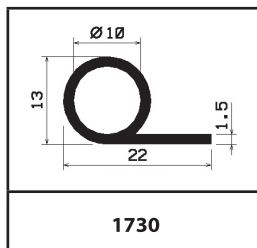

1730

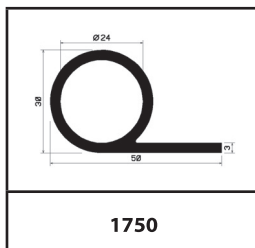

1750

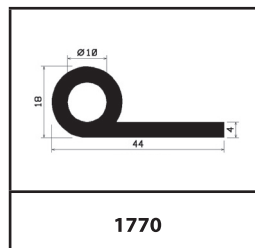

1770

○ mikroporézni, mikroporézni/silikonové ● gumové, silikonové

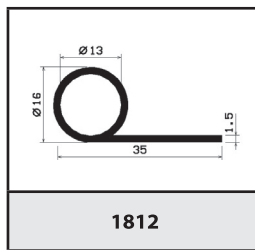

1812

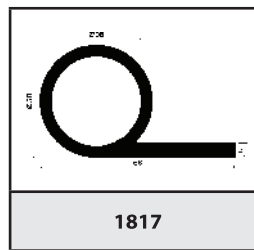

1817

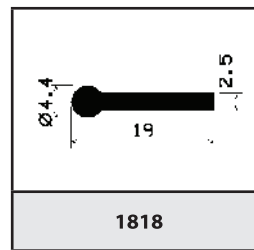

1818

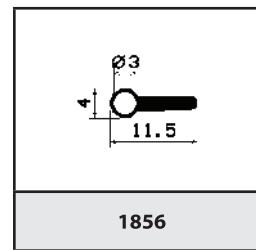

1856

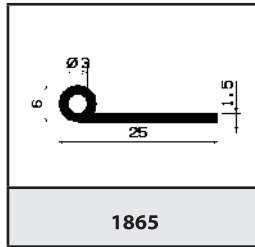

1865

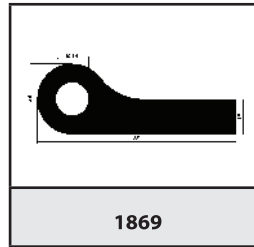

1869

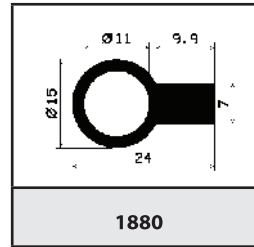

1880

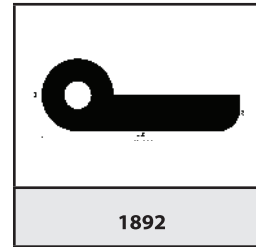

1892

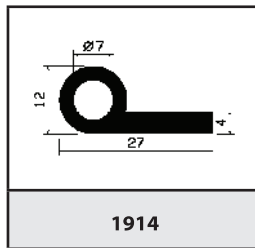

1914

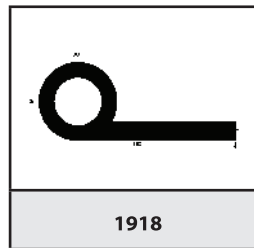

1918

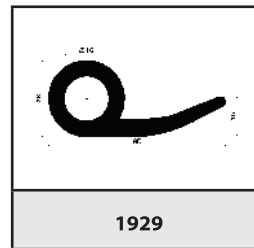

1929

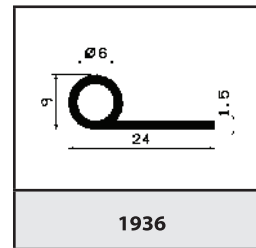

1936

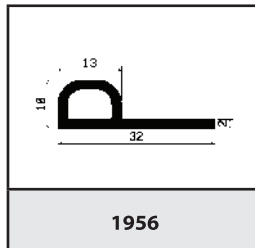

1956

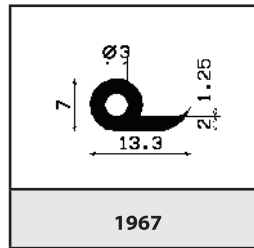

1967

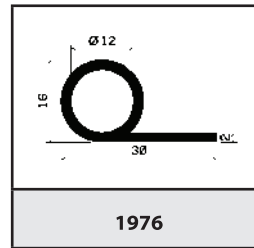

1976

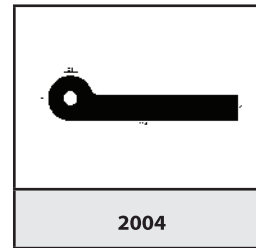

2004

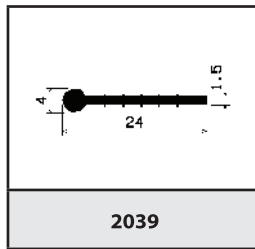

2039

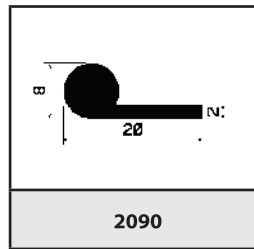

2090

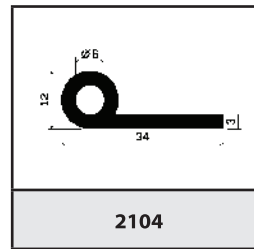

2104

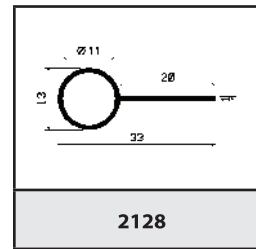

2128

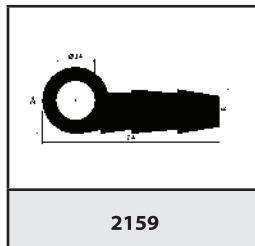

2159

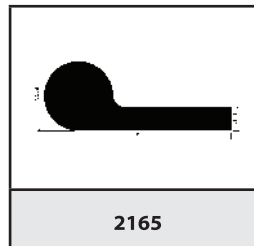

2165

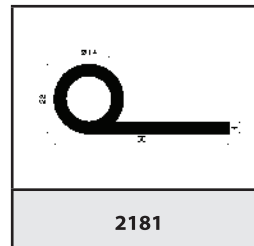

2181

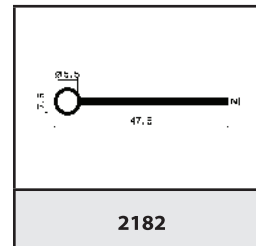

2182

○ mikroporézní, mikroporézní/silikonové ● gumové, silikonové

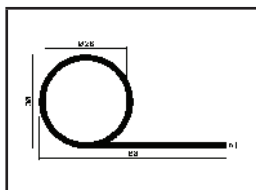

2186

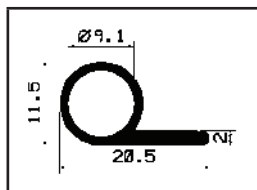

2203

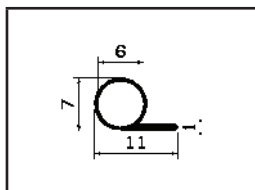

2206

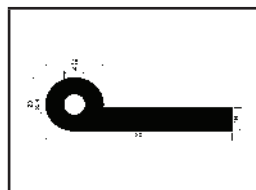

2209

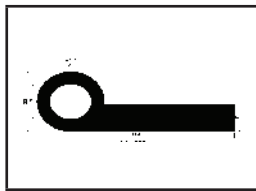

2229

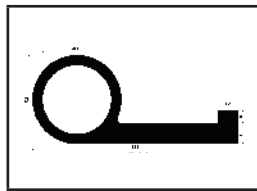

2251

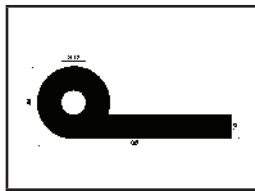

2253

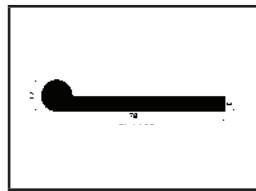

2255

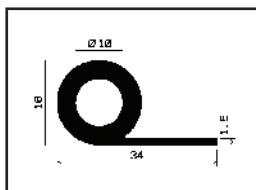

2256

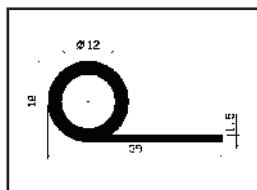

2268

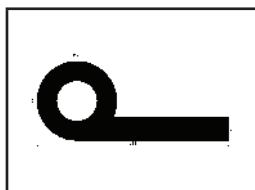

2295

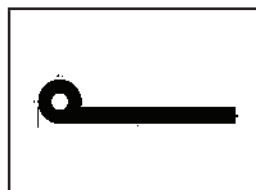

2296

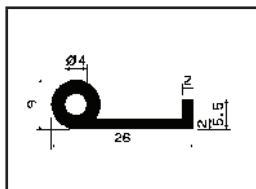

2307

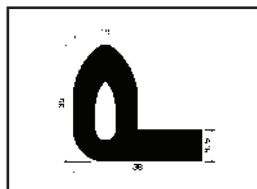

2321

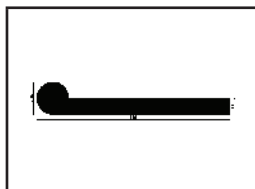

2334

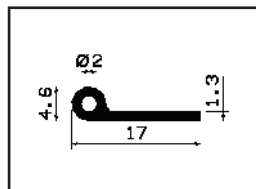

2340

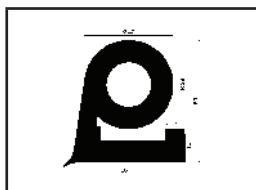

2346

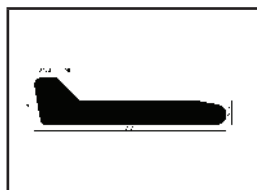

2364



2368

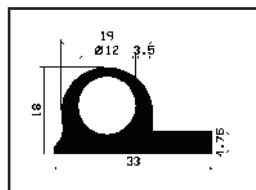

2377

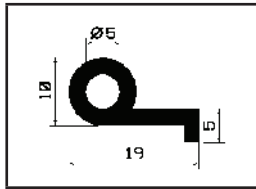

2395

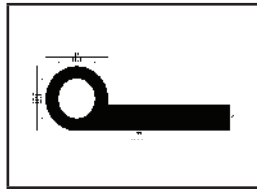

2399

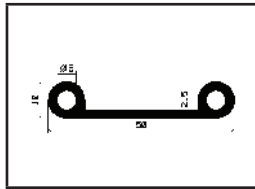

2401

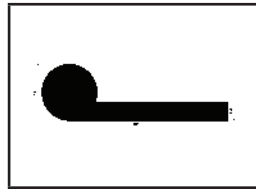

2439

○ mikroporézni, mikroporézni/silikonové ● gumové, silikonové

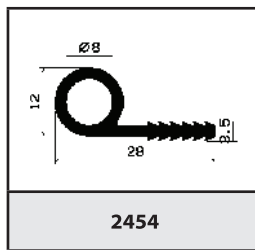

2454

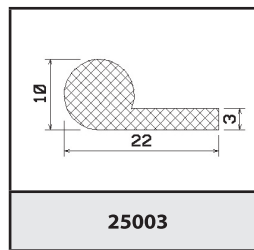

25003

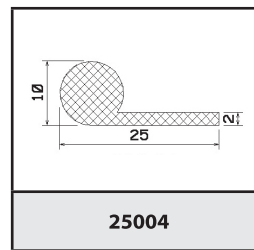

25004

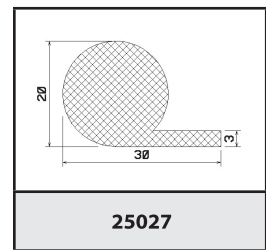

25027

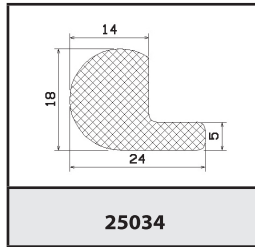

25034

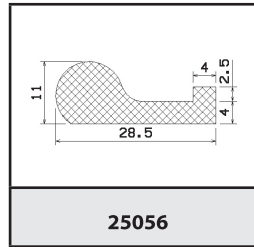

25056

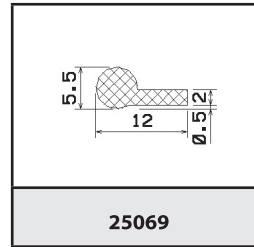

25069

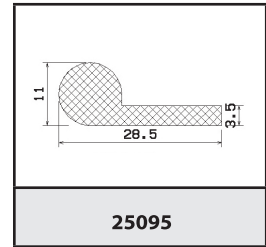

25095

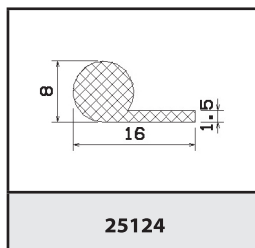

25124

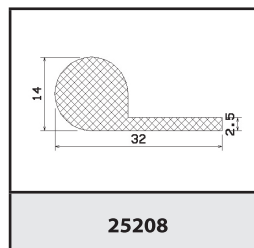

25208

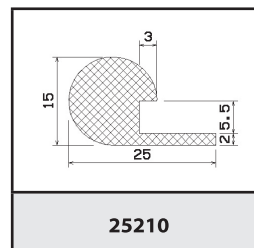

25210

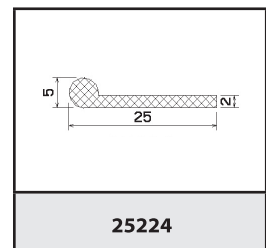

25224

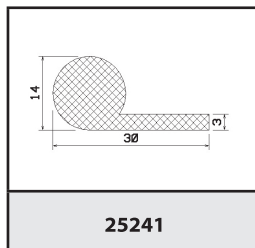

25241

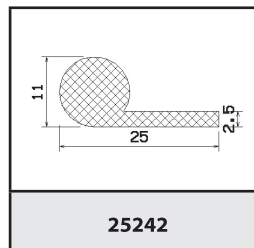

25242

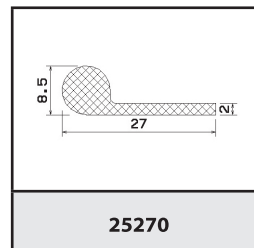

25270

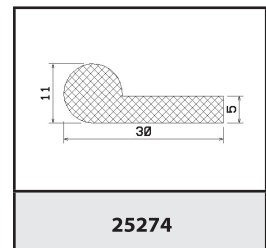

25274

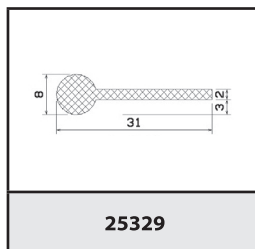

25329

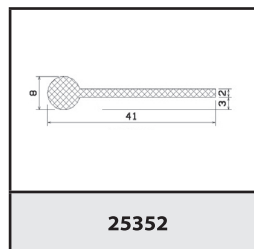

25352

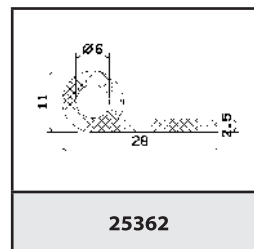

25362

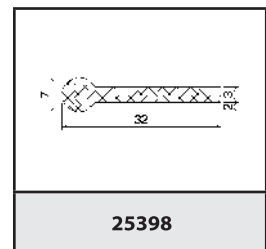

25398

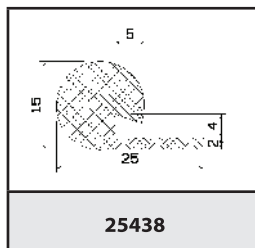

25438

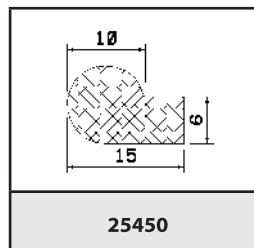

25450

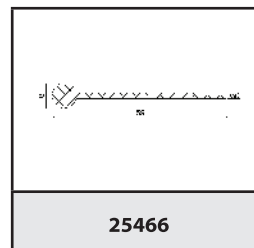

25466

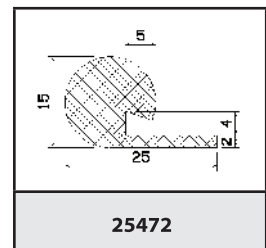

25472

○ mikroporézní, mikroporézní/silikonové ● gumové, silikonové

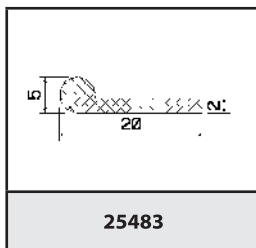

25483

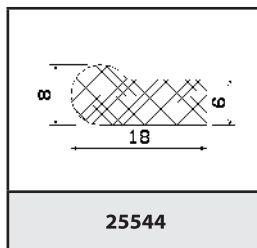

25544

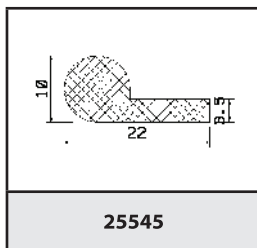

25545

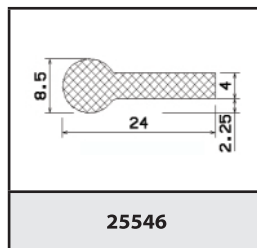

25546

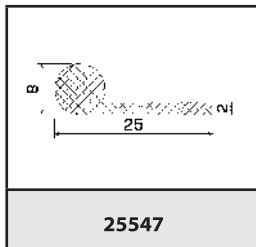

25547

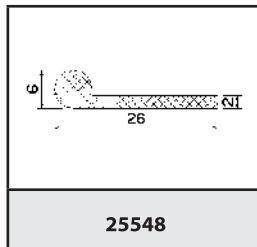

25548

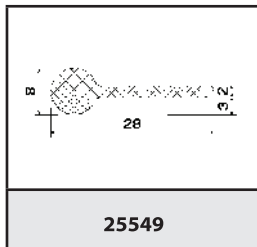

25549

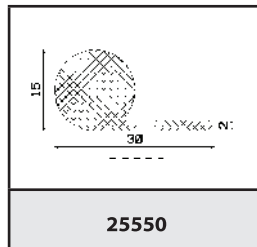

25550

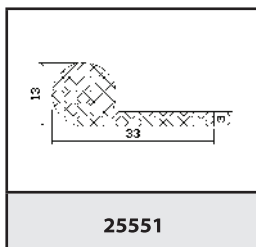

25551

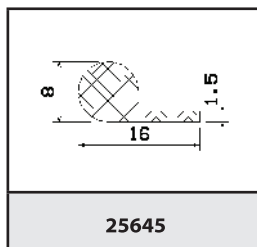

25645

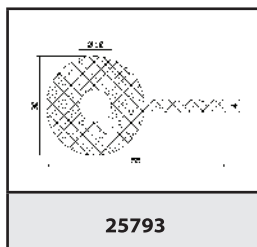

25793

○ mikroperézni, mikroperézni/silikonové ● gumové, silikonové

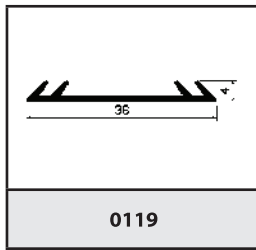

0119

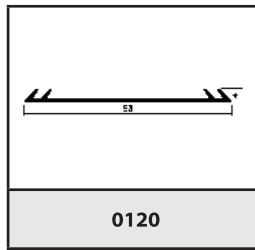

0120

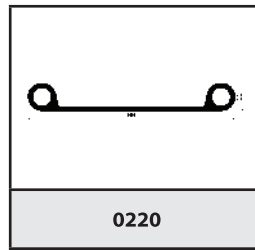

0220

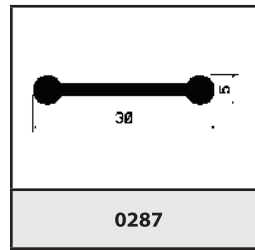

0287

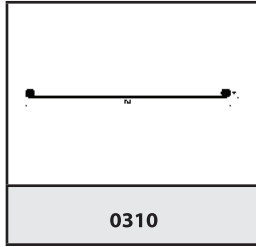

0310

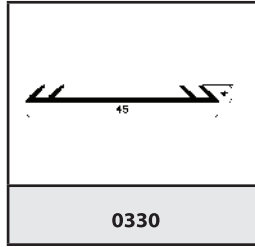

0330

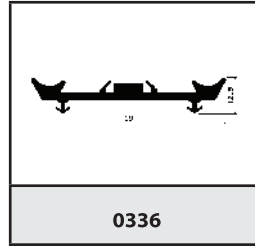

0336

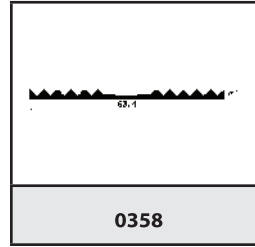

0358

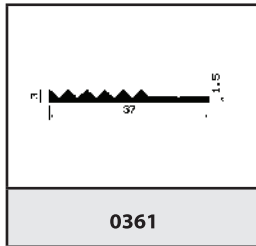

0361

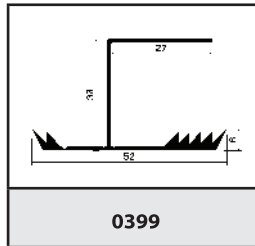

0399

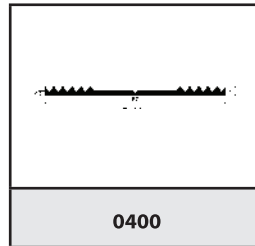

0400

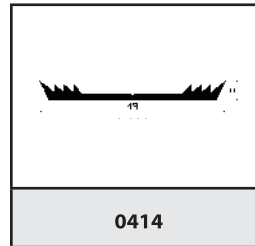

0414

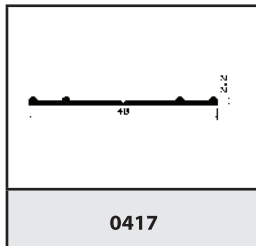

0417

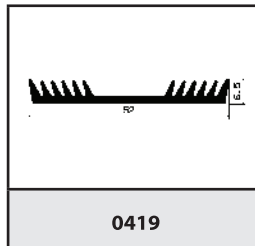

0419

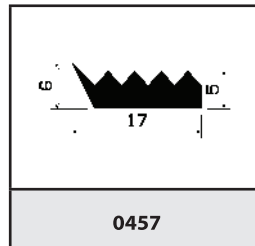

0457

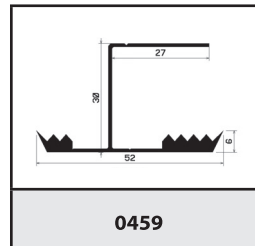

0459

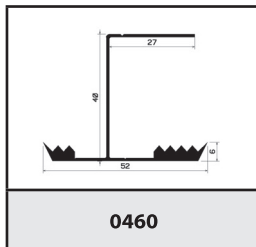

0460

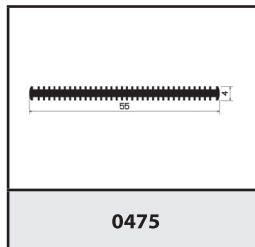

0475

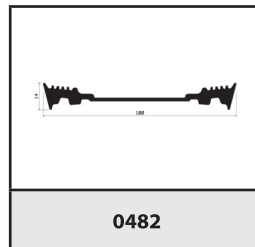

0482

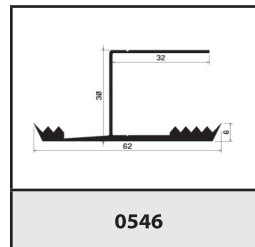

0546

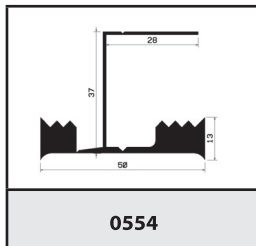

0554

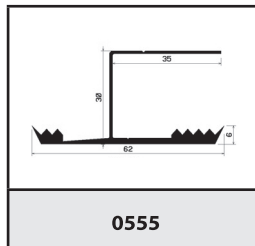

0555

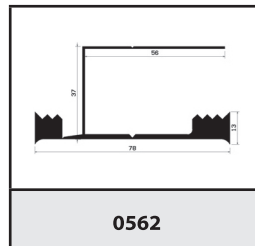

0562

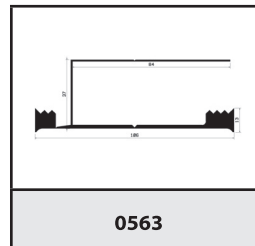

0563

○ mikroporézní, mikroporézní/silikonové ● gumové, silikonové

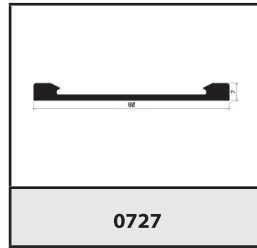
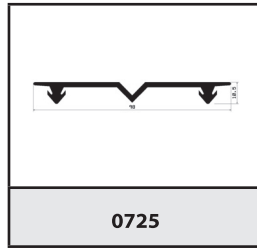
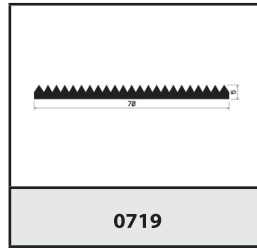
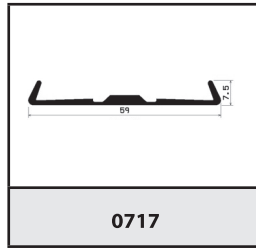
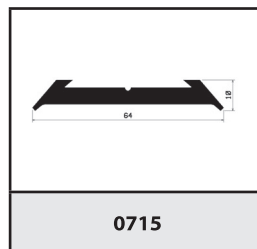
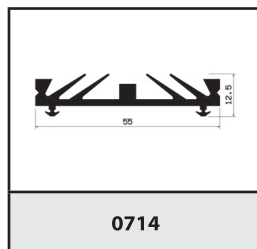
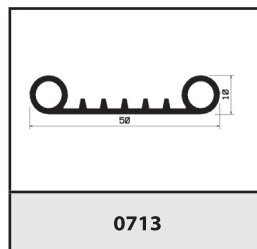
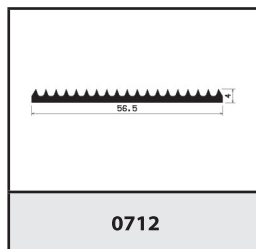
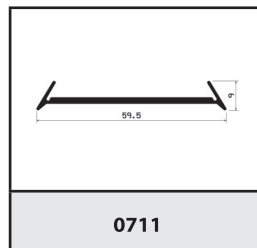
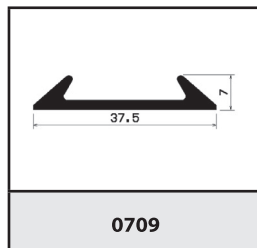
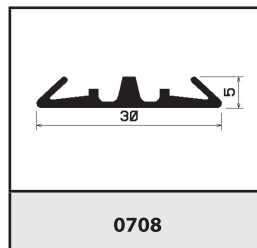
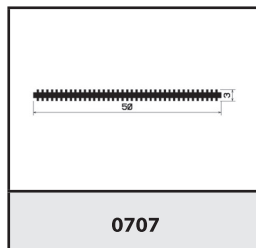
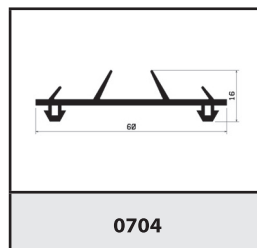
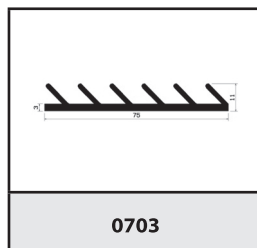
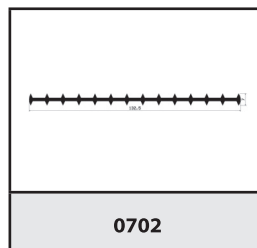
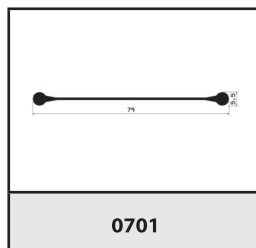
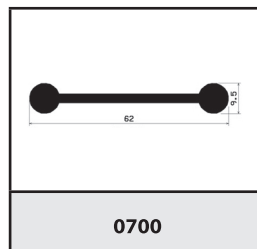
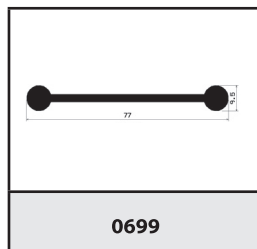
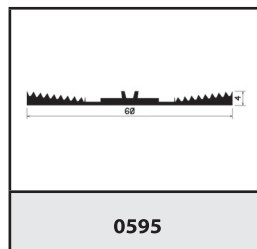
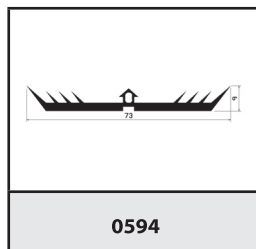
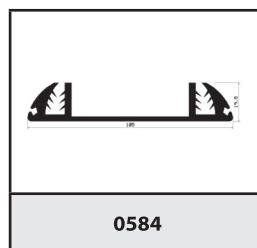
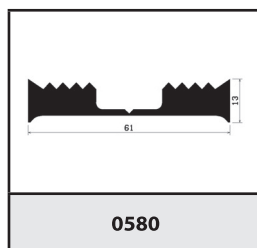
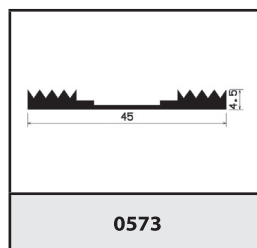
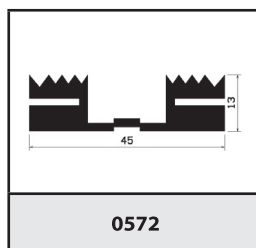

○ mikroporézní, mikroporézní/silikonové ● gumové, silikonové

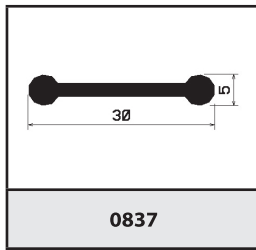

0837

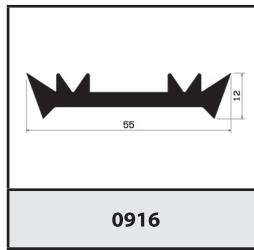

0916

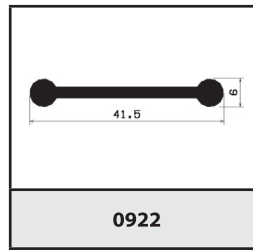

0922

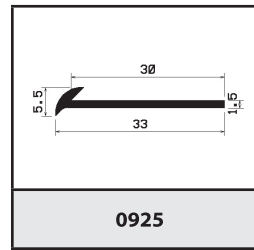

0925

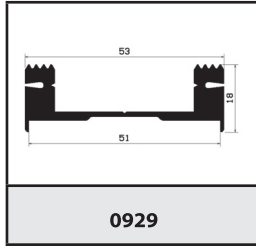

0929

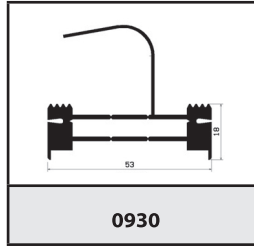

0930

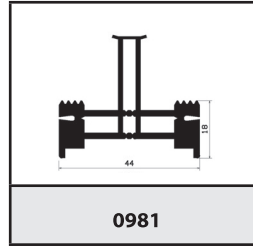

0981

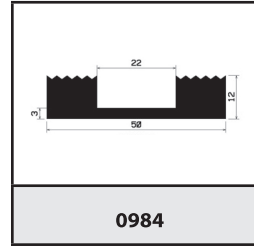

0984

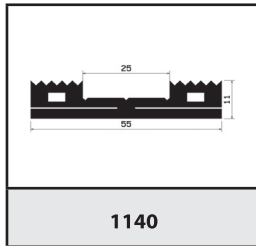

1140

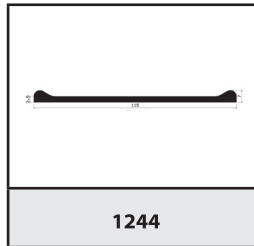

1244

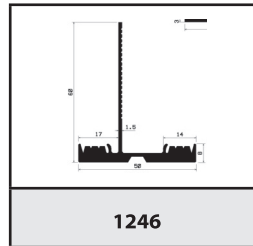

1246

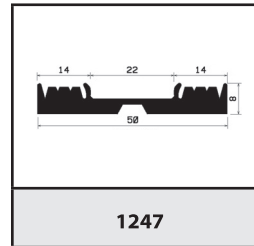

1247

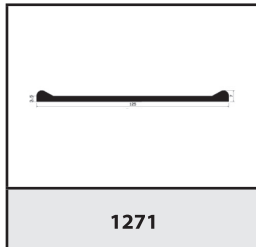

1271

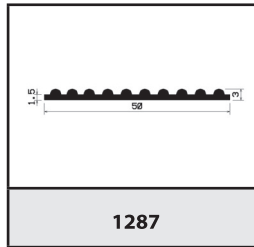

1287

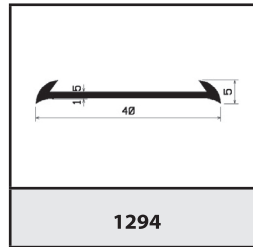

1294

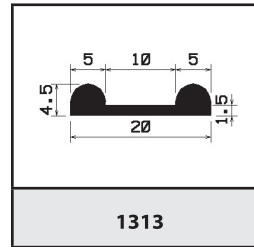

1313

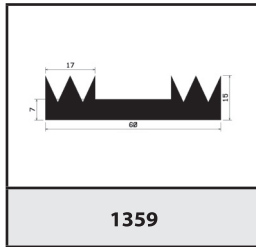

1359

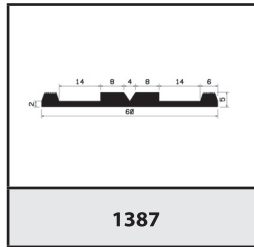

1387

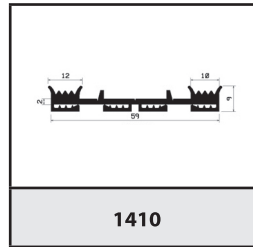

1410

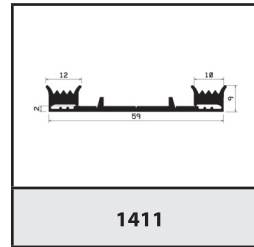

1411

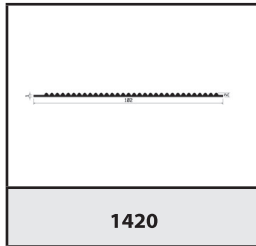

1420

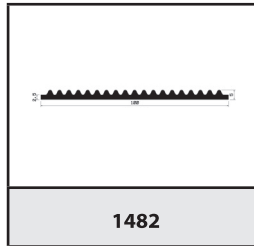

1482

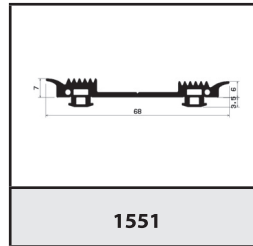

1551

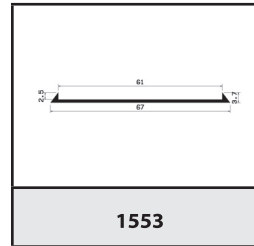

1553

○ mikroporézní, mikroporézní/silikonové ● gumové, silikonové

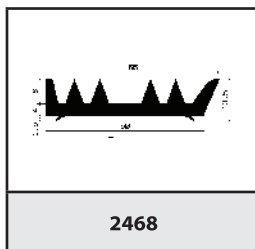
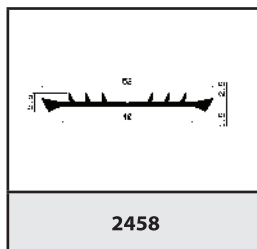
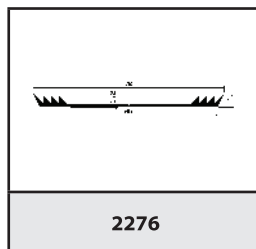
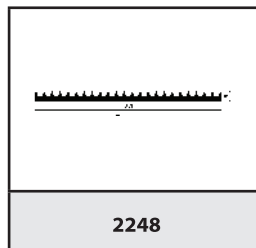
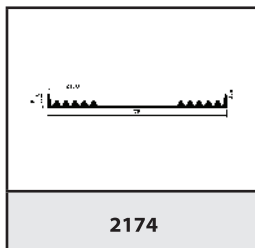
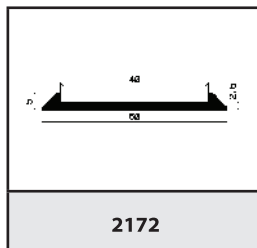
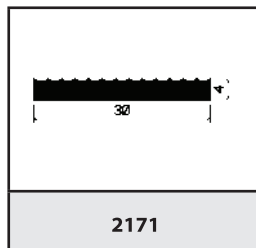
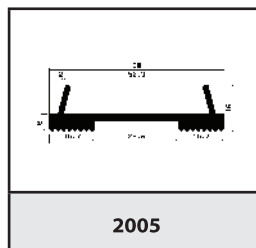
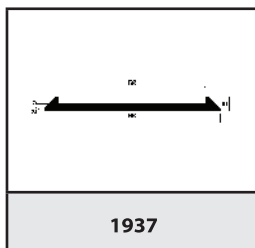
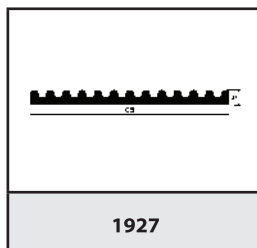
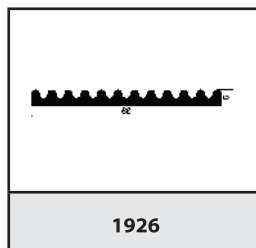
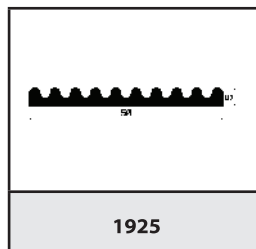
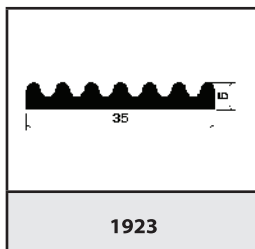
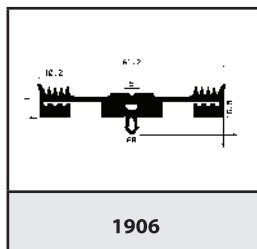
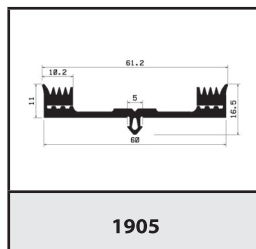
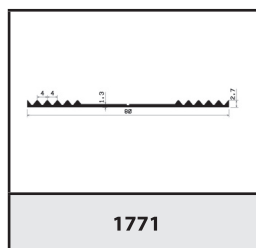
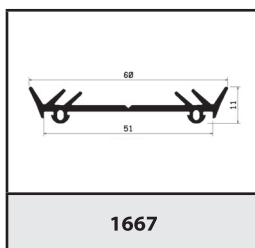
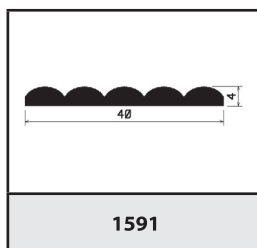
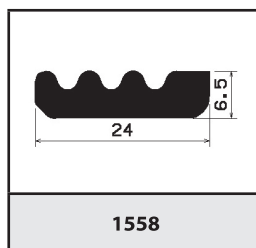

○ mikroperzní, mikroperzní/silikonové ● gumové, silikonové

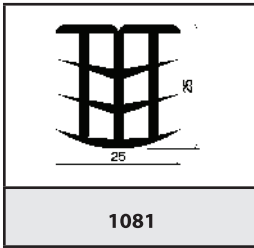
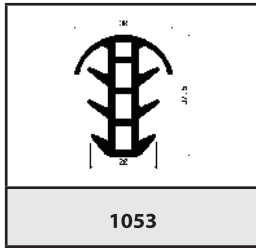
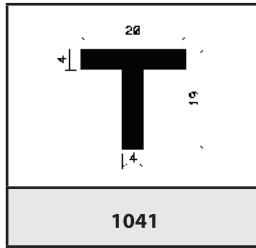
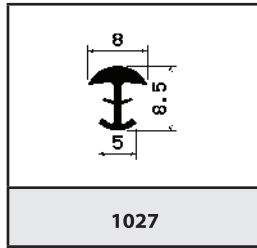
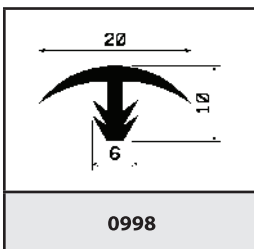
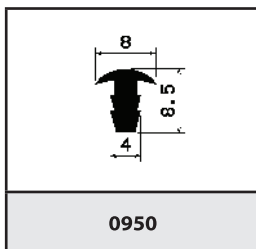
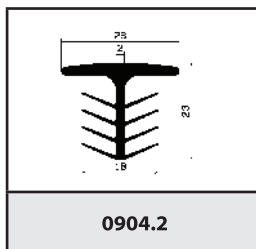
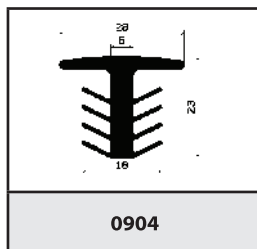
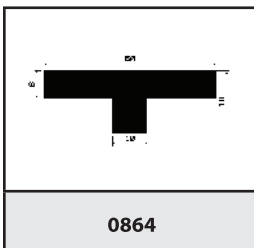
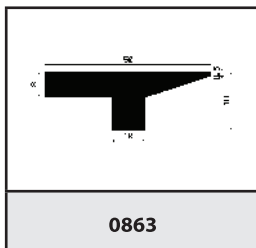
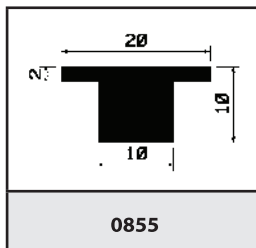
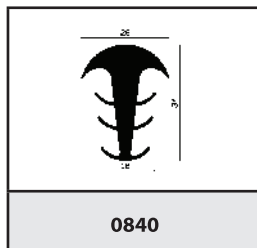
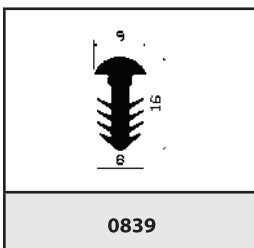
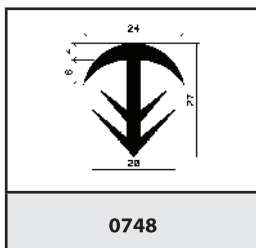
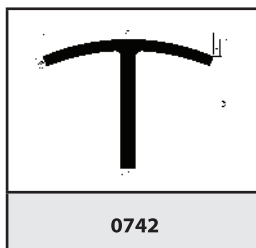
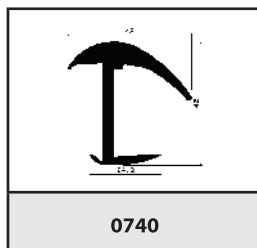
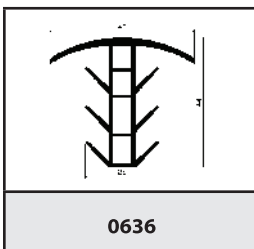
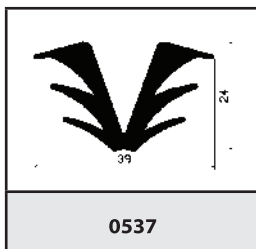
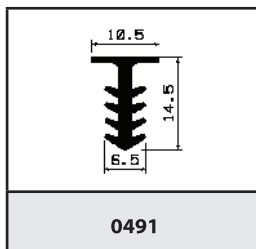
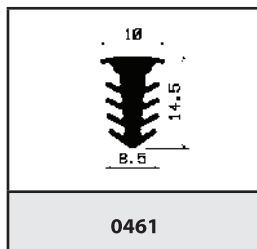
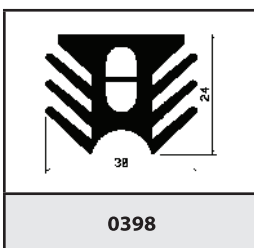
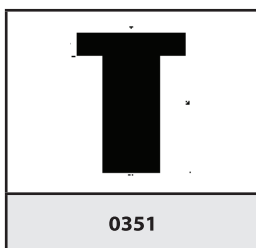
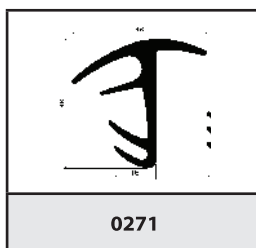
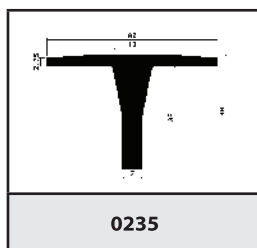

○ mikroporézní, mikroporézní/silikonové ● gumové, silikonové

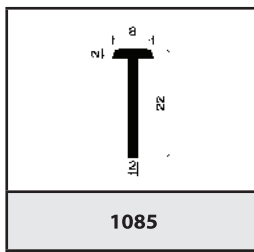

1085

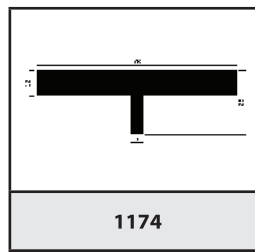

1174

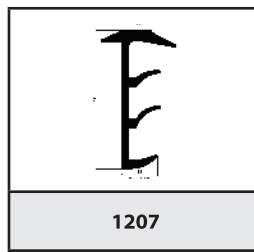

1207

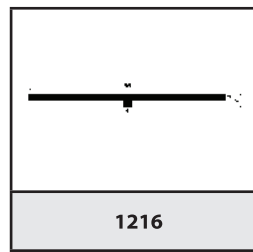

1216

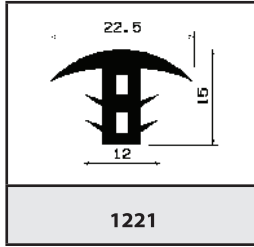

1221

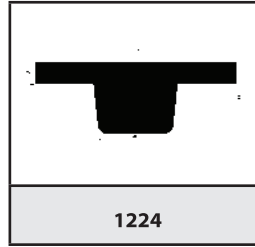

1224

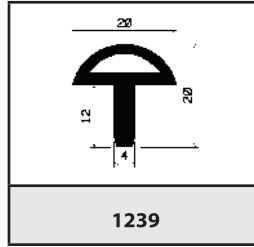

1239

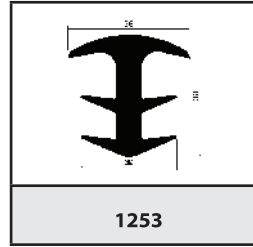

1253

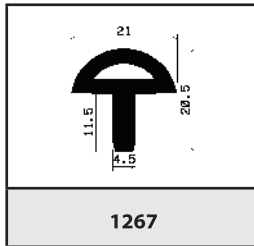

1267

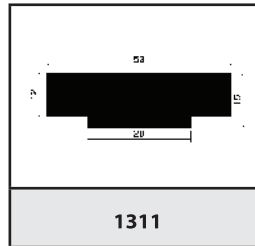

1311

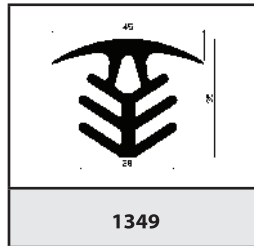

1349

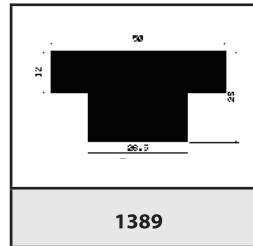

1389

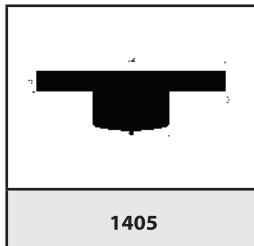

1405

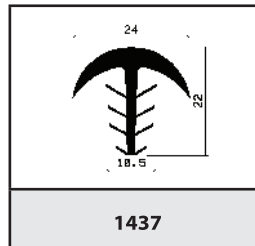

1437

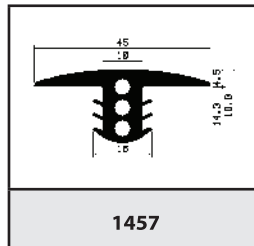

1457

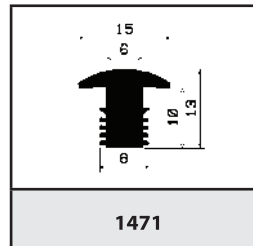

1471

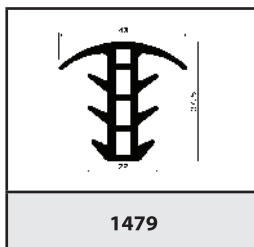

1479

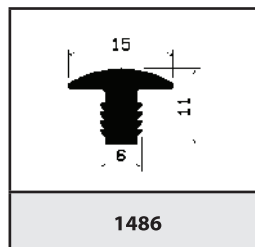

1486

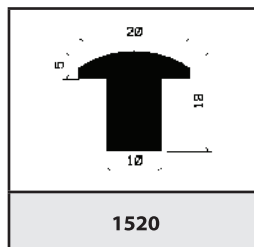

1520

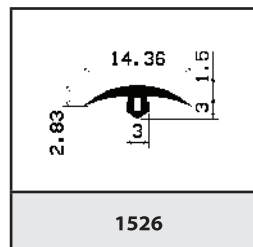

1526

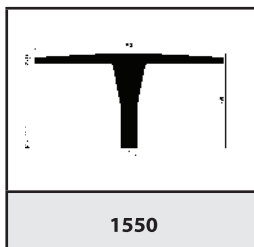

1550

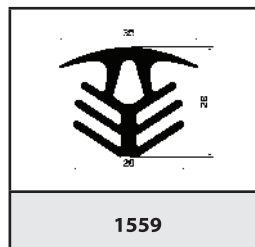

1559

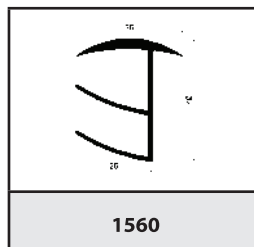

1560

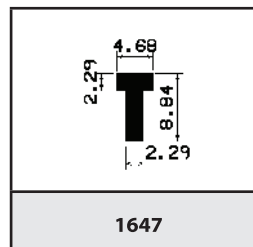

1647

○ mikroporézni, mikroporézni/silikonové ● gumové, silikonové

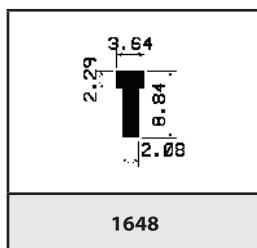

1648

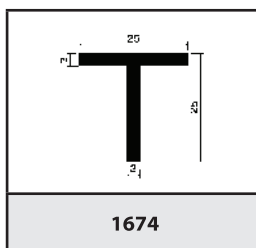

1674

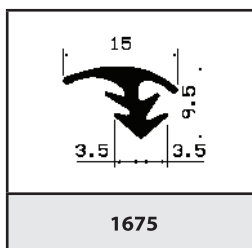

1675

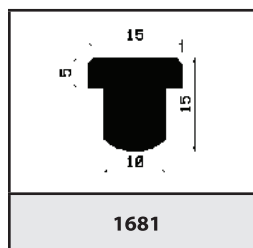

1681

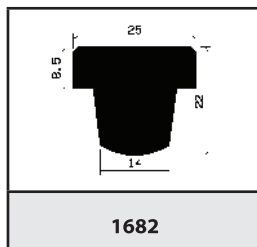

1682

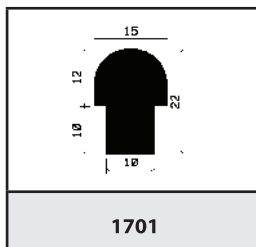

1701

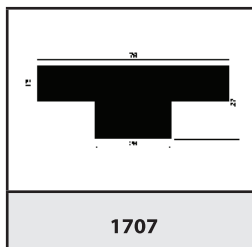

1707

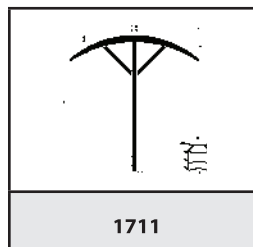

1711

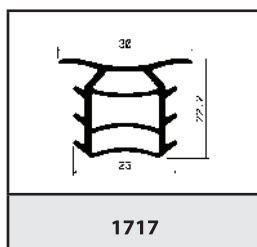

1717

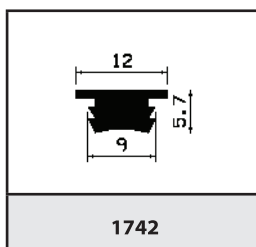

1742

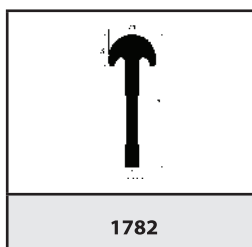

1782

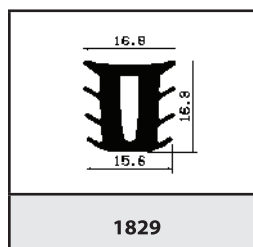

1829

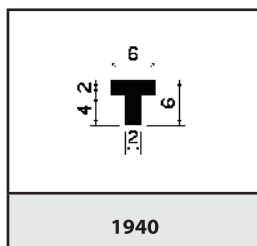

1940

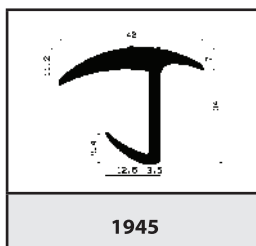

1945

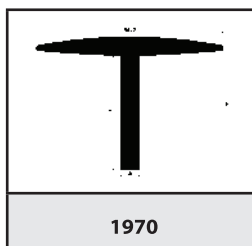

1970

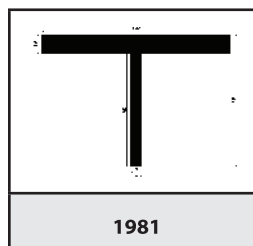

1981

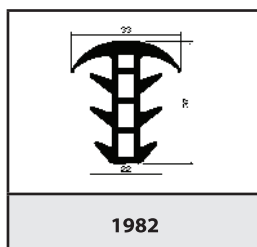

1982

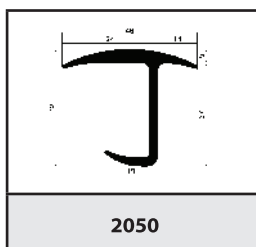

2050

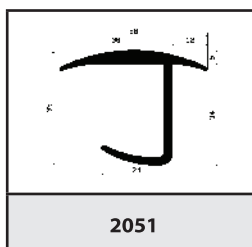

2051

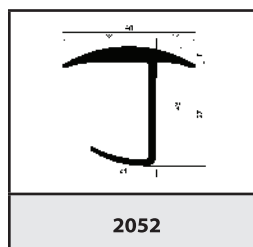

2052

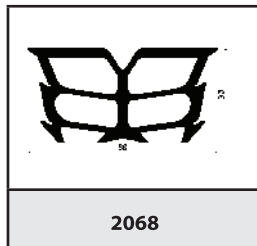

2068

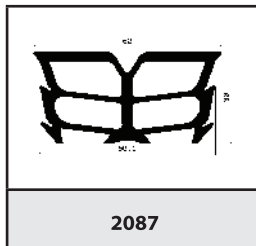

2087

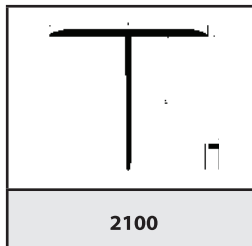

2100

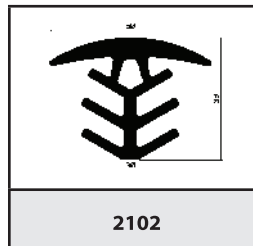

2102

○ mikroporézní, mikroporézní/silikonové ● gumové, silikonové

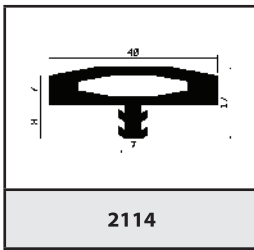

2114

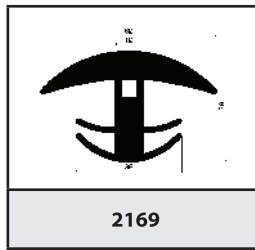

2169

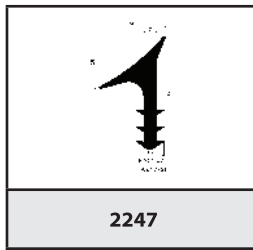

2247

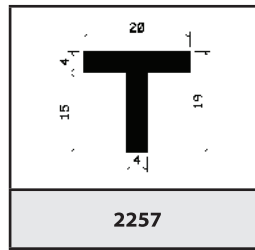

2257

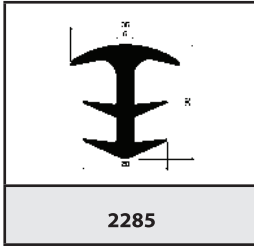

2285

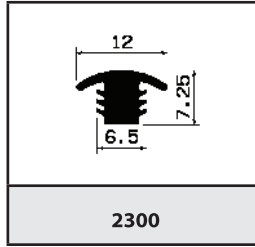

2300

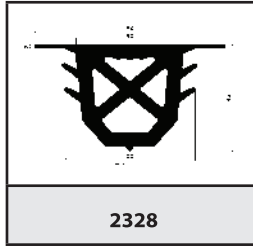

2328

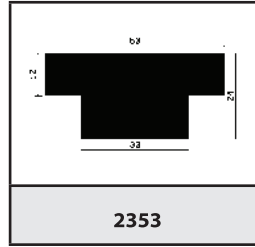

2353

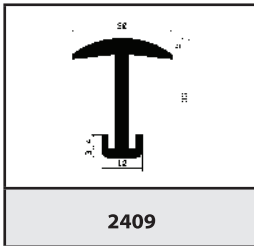

2409

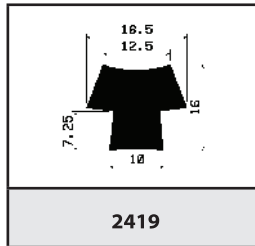

2419

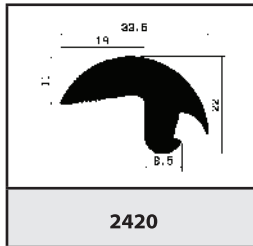

2420

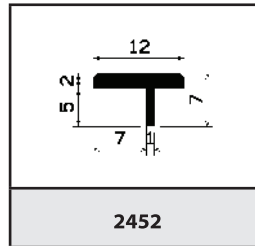

2452

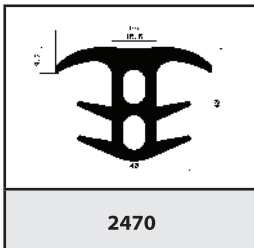

2470

○ mikroporézní, mikroporézní/silikonové ● gumové, silikonové

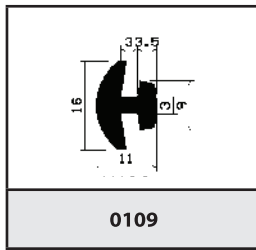

0109

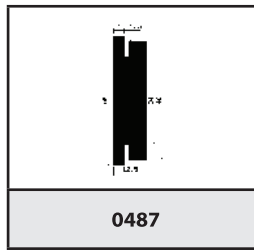

0487

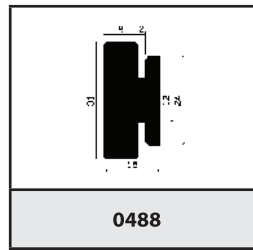

0488

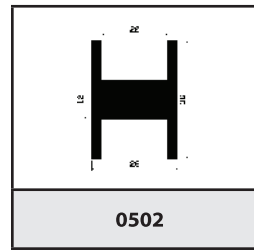

0502

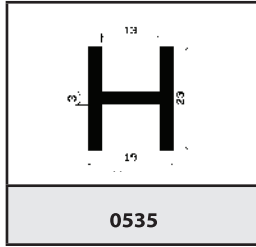

0535

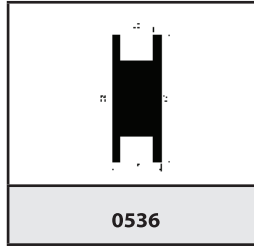

0536

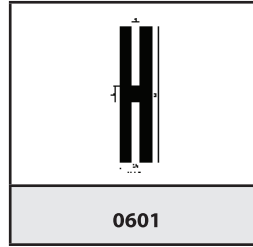

0601

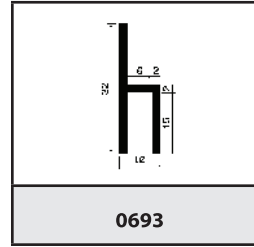

0693

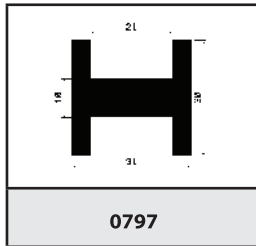

0797

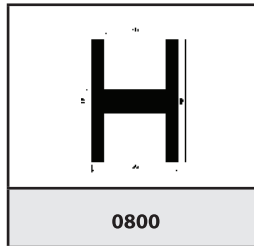

0800

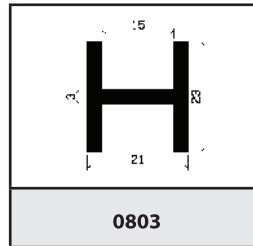

0803

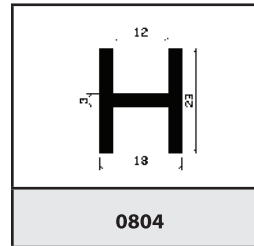

0804

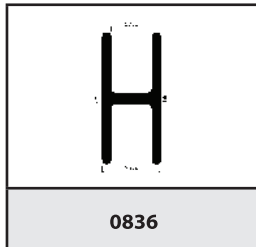

0836

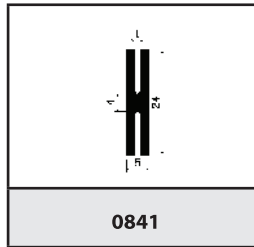

0841

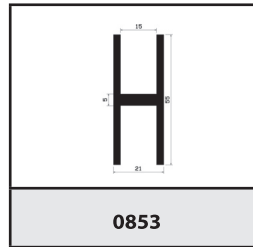

0853

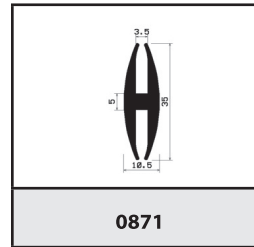

0871

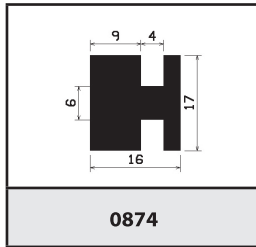

0874

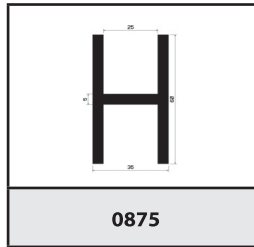

0875

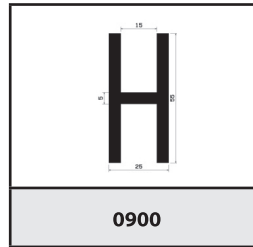

0900

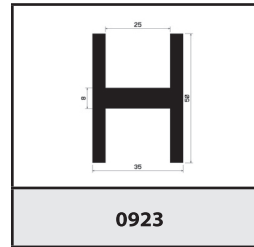

0923

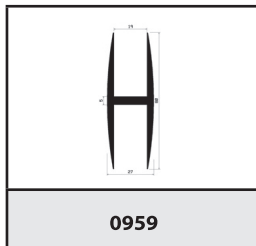

0959

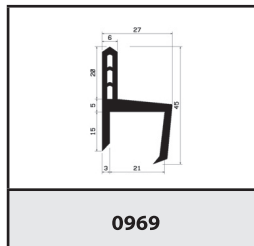

0969

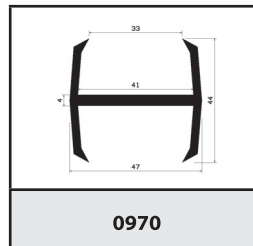

0970

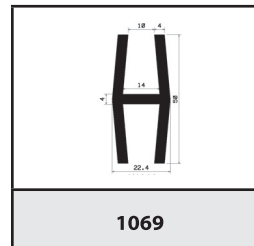

1069

○ mikroporézní, mikroporézní/silikonové ● gumové, silikonové

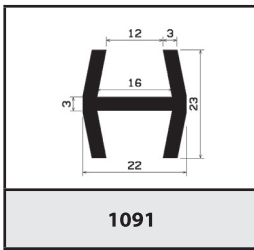

1091

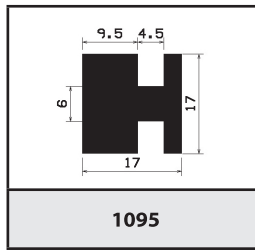

1095

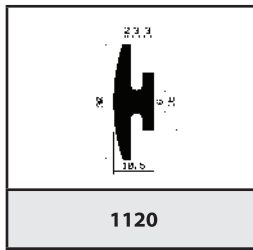

1120

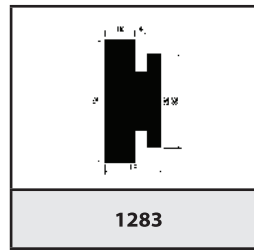

1283

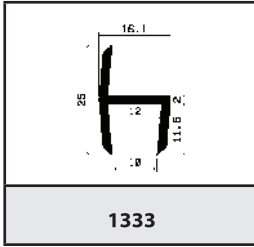

1333

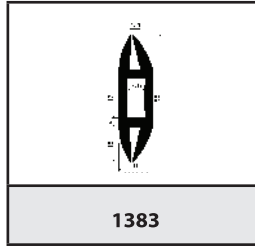

1383

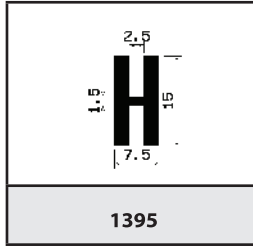

1395

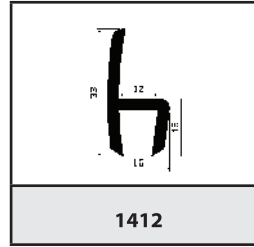

1412

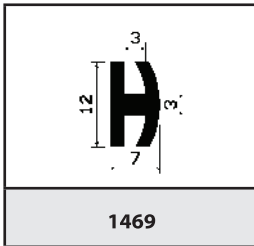

1469

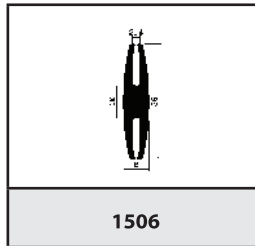

1506

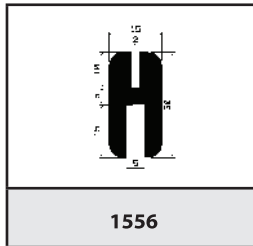

1556

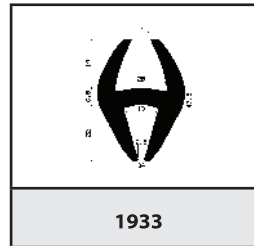

1933

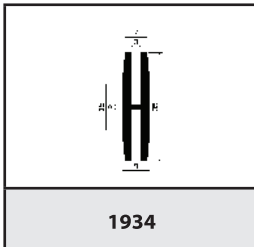

1934

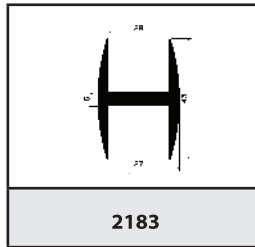

2183

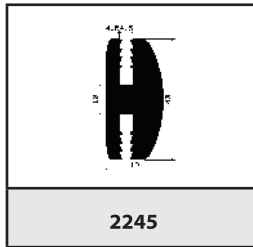

2245

○ mikroporézni, mikroporézni/silikonové ● gumové, silikonové

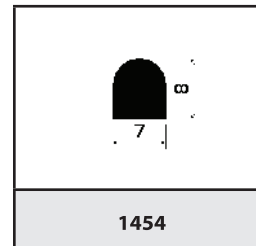
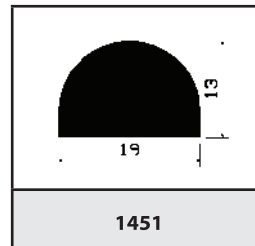
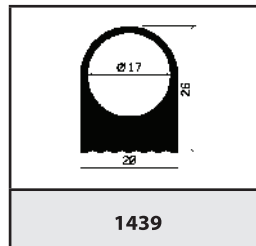
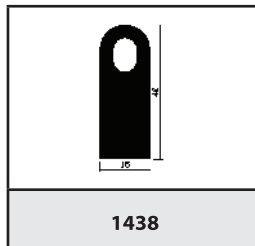
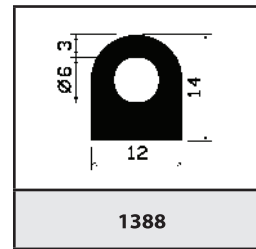
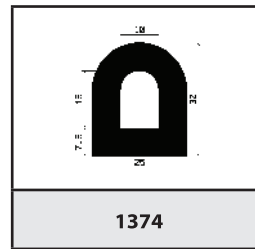
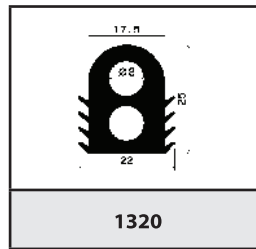
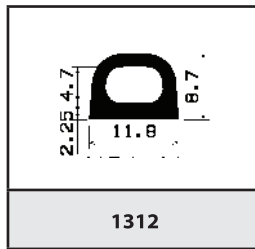
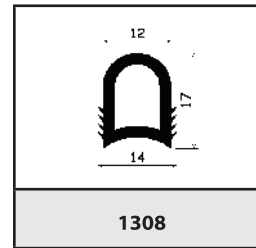
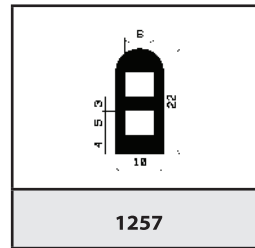
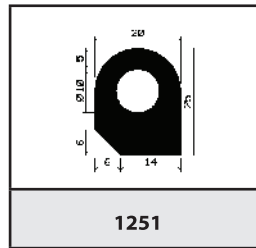
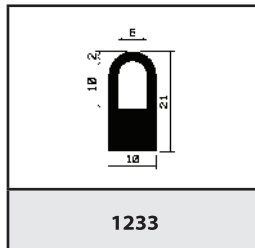
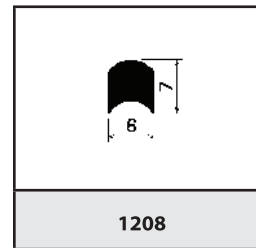
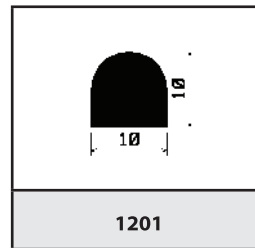
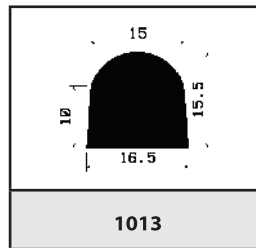
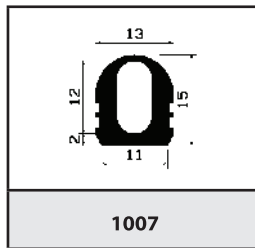
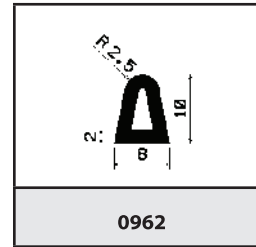
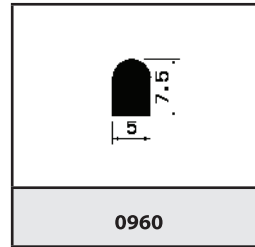
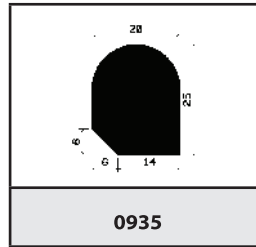
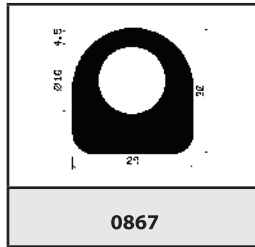
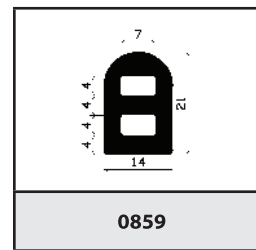
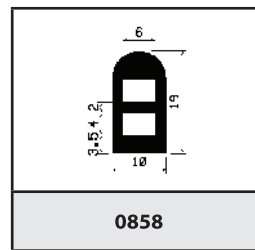
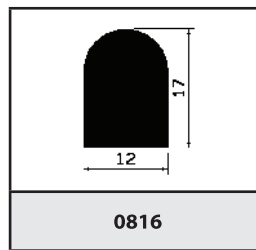
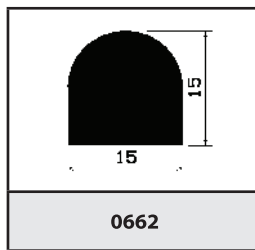

○ mikroporézní, mikroporézní/silikonové ● gumové, silikonové

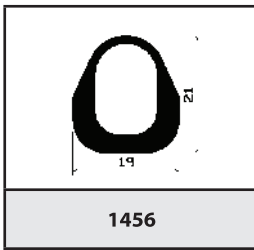

1456

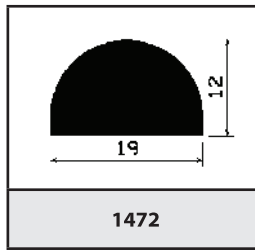

1472

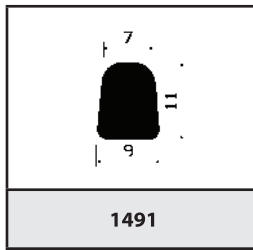

1491

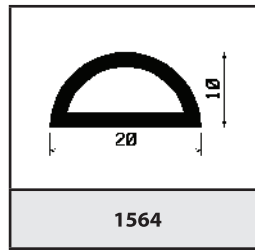

1564

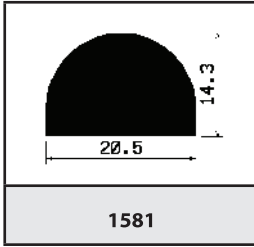

1581

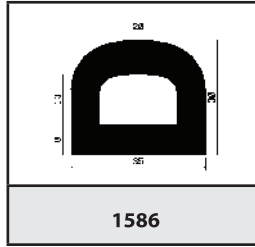

1586

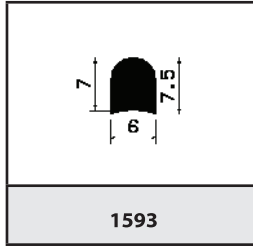

1593

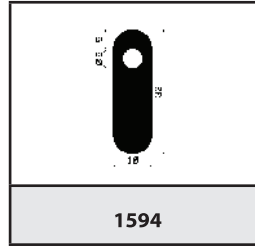

1594

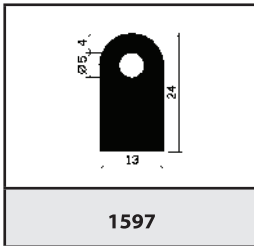

1597

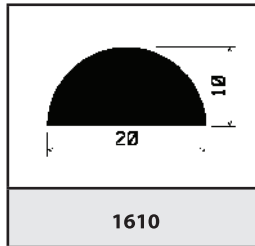

1610

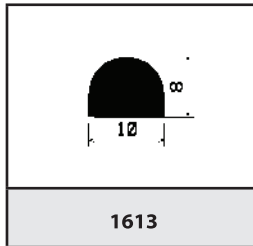

1613

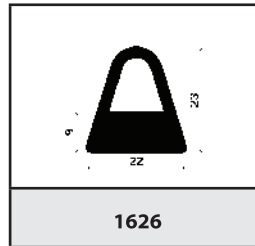

1626

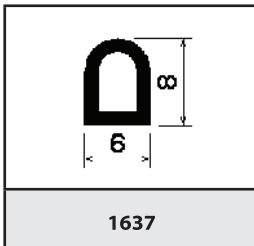

1637

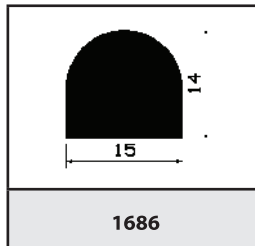

1686

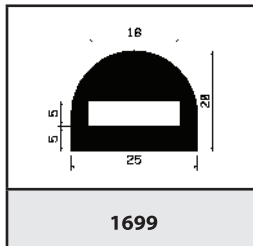

1699

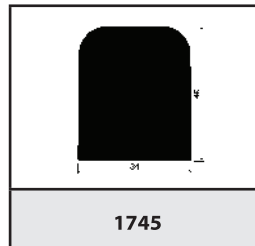

1745

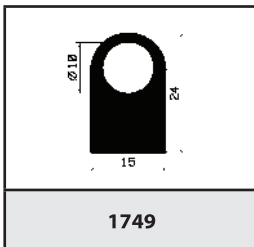

1749

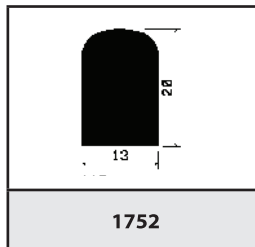

1752

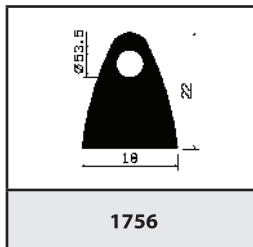

1756

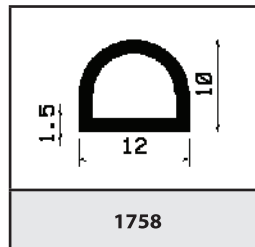

1758

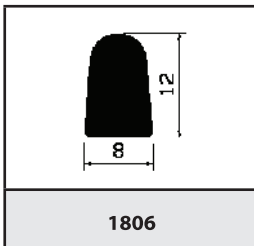

1806

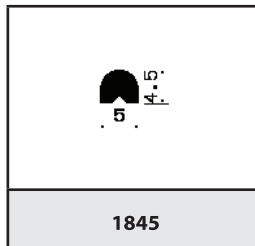

1845

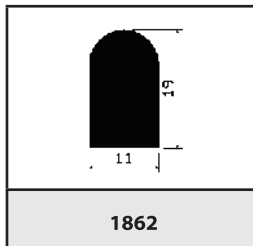

1862

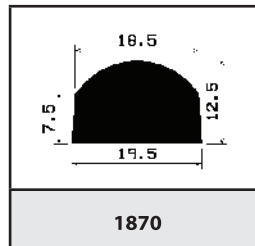

1870

○ mikroporézni, mikroporézni/silikonové ● gumové, silikonové

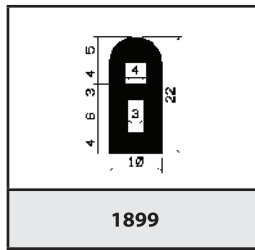

1899

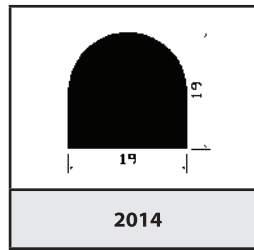

2014

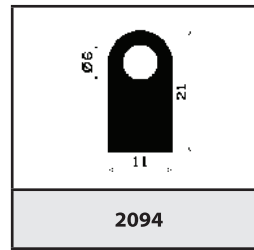

2094

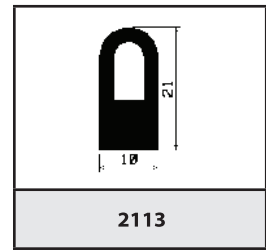

2113

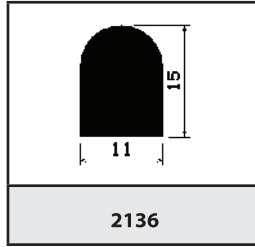

2136

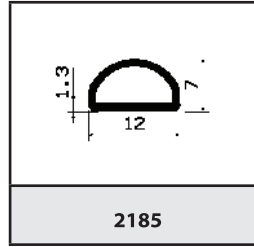

2185

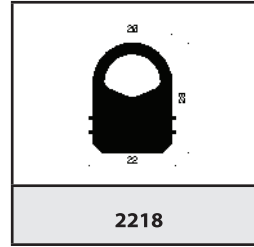

2218

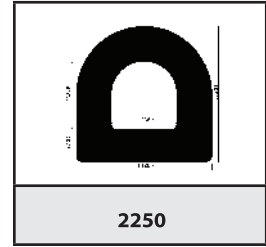

2250

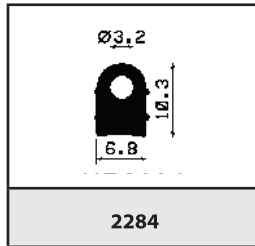

2284

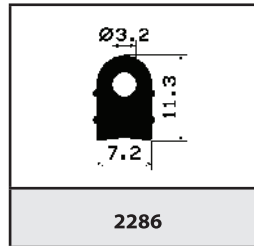

2286

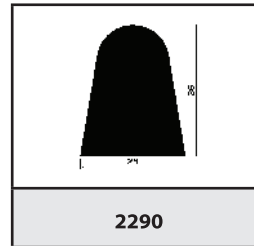

2290

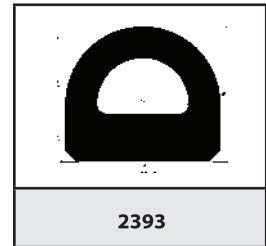

2393

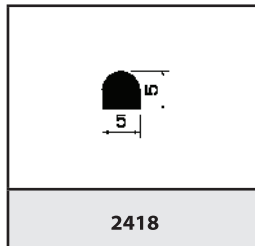

2418

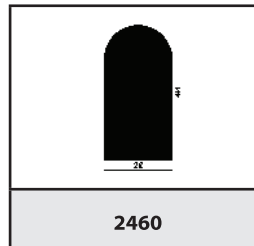

2460

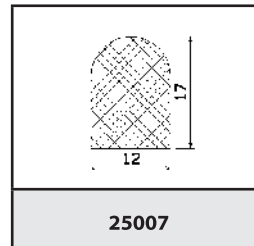

25007

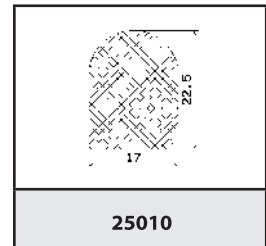

25010

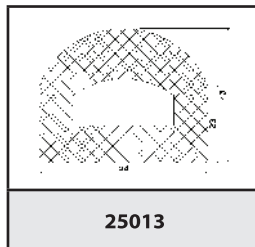

25013

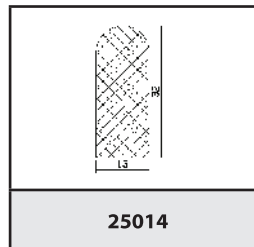

25014

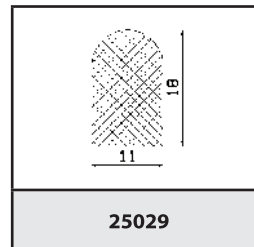

25029

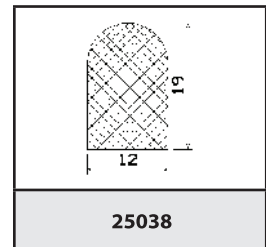

25038

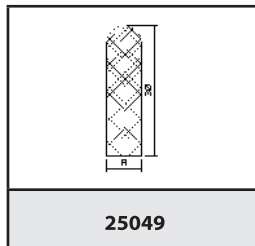

25049

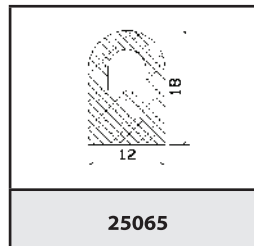

25065

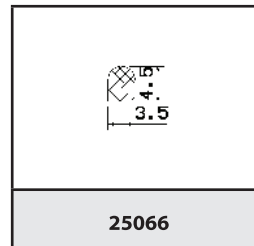

25066

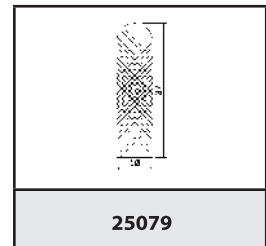

25079

○ mikroporézní, mikroporézní/silikonové ● gumové, silikonové

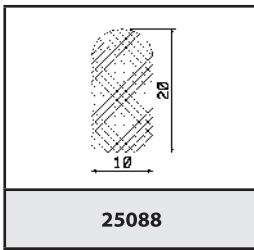

25088

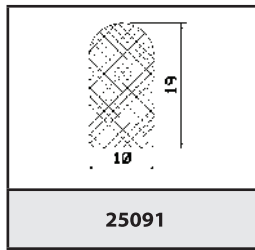

25091

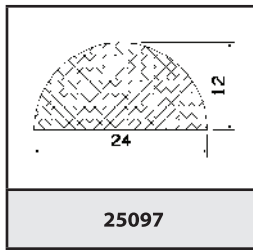

25097

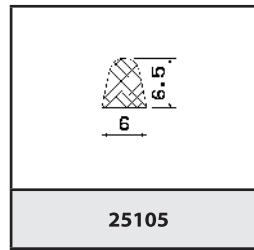

25105

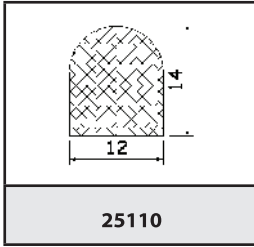

25110

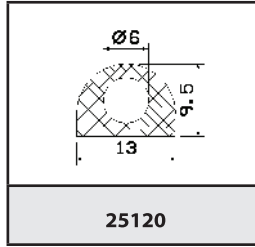

25120

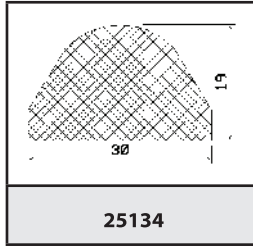

25134

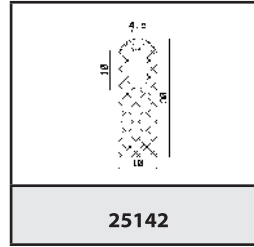

25142

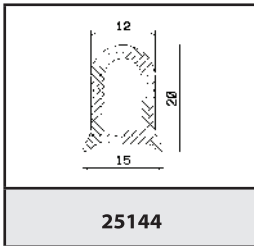

25144

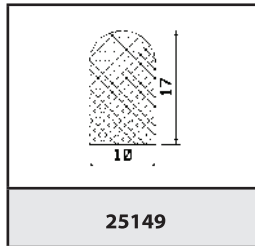

25149

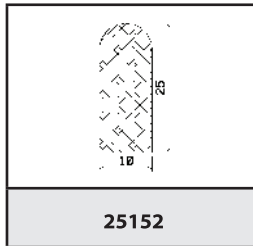

25152

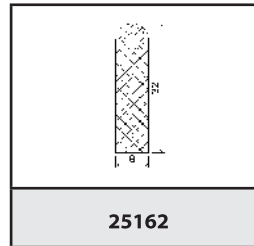

25162

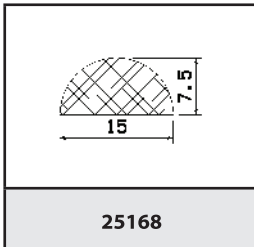

25168

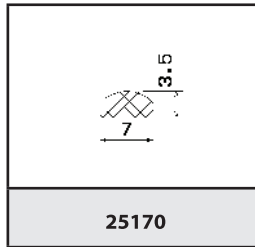

25170

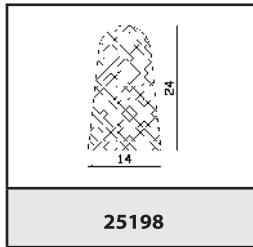

25198

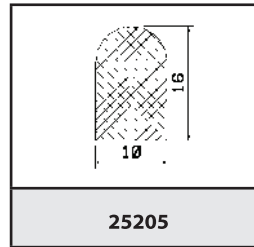

25205

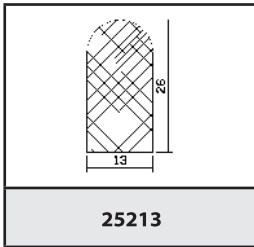

25213

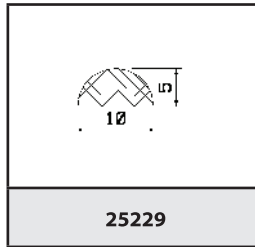

25229

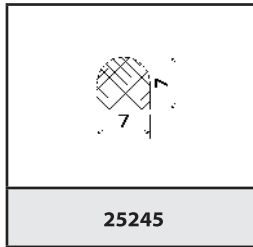

25245

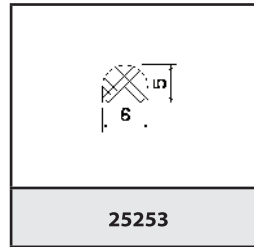

25253

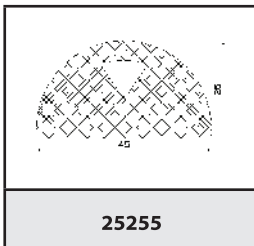

25255

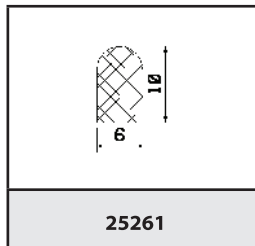

25261

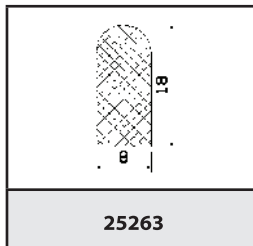

25263

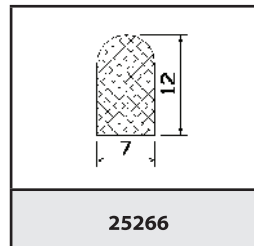

25266

○ mikroporézni, mikroporézni/silikonové ● gumové, silikonové

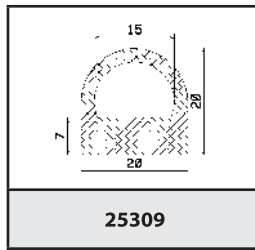

25309

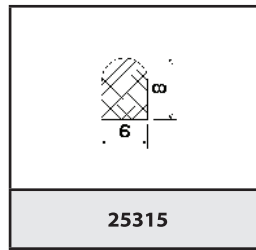

25315

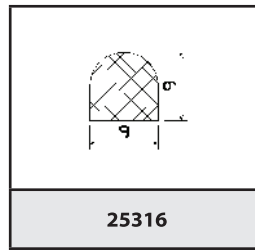

25316

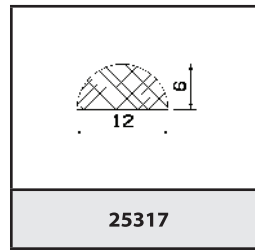

25317

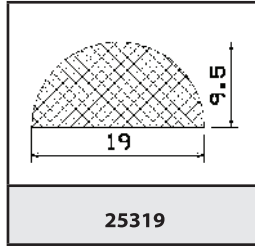

25319

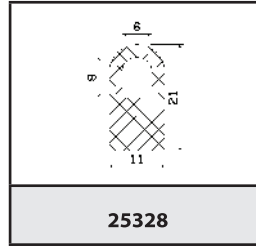

25328

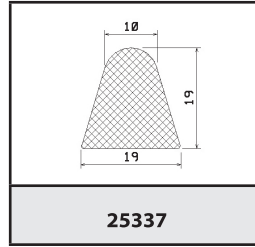

25337

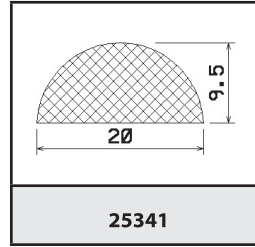

25341

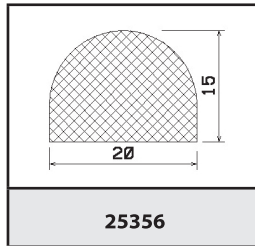

25356

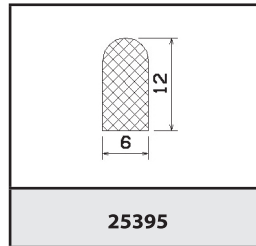

25395

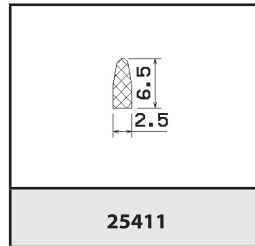

25411

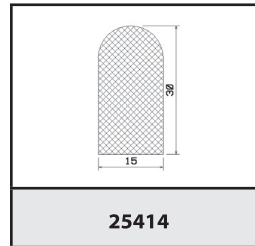

25414

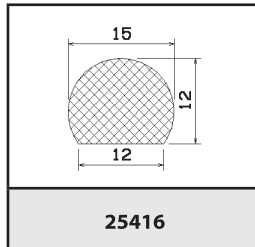

25416

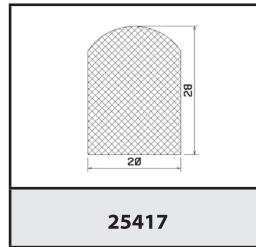

25417

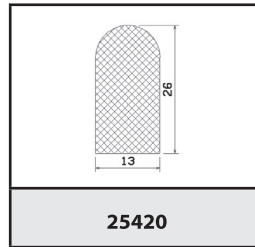

25420

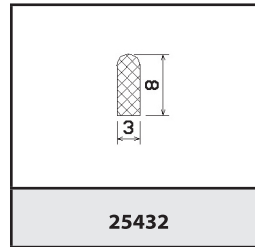

25432

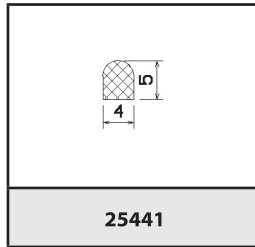

25441

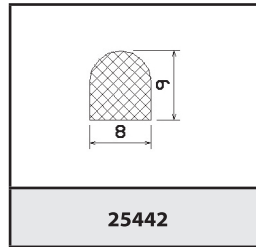

25442

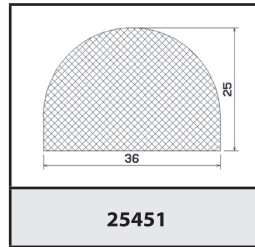

25451

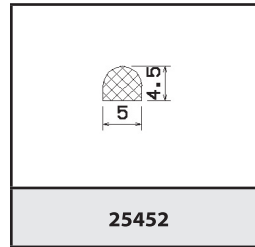

25452

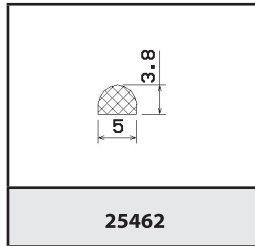

25462

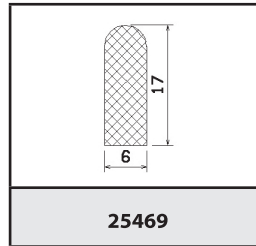

25469

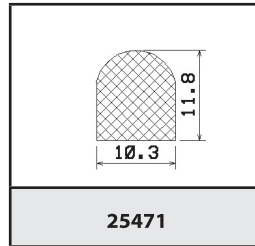

25471

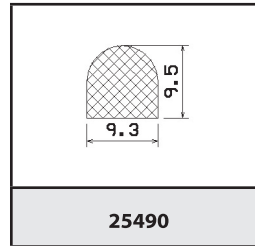

25490

○ mikroporézní, mikroporézní/silikonové ● gumové, silikonové

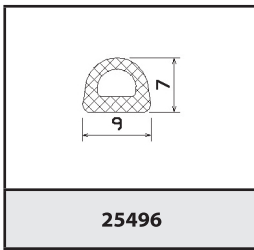

25496

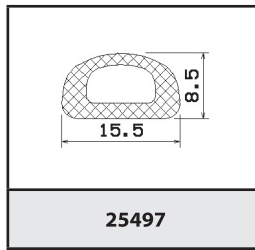

25497

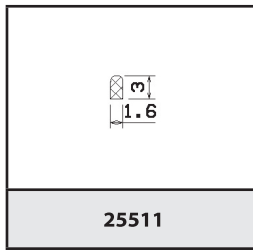

25511

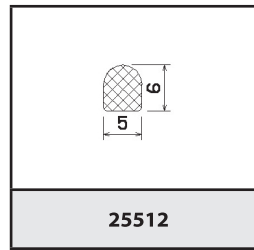

25512

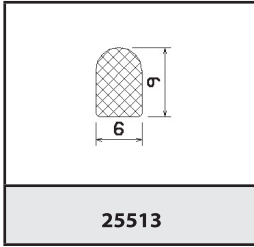

25513

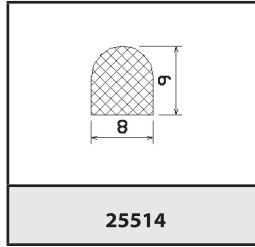

25514

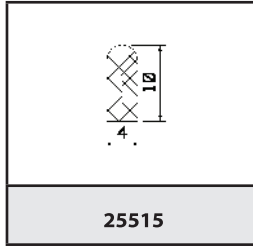

25515

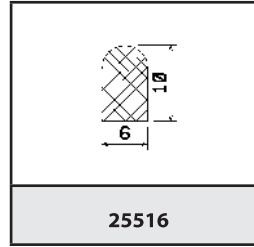

25516

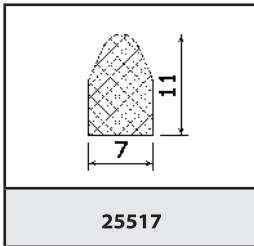

25517

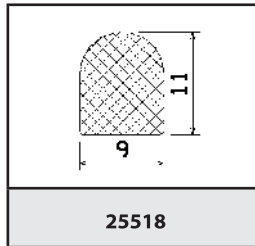

25518

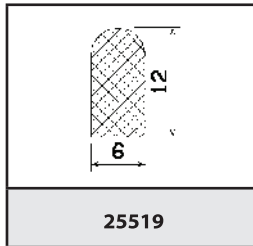

25519

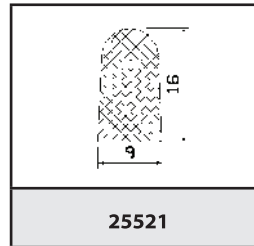

25521

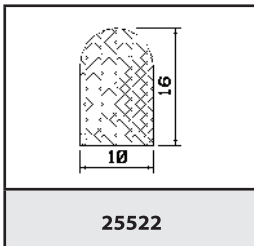

25522

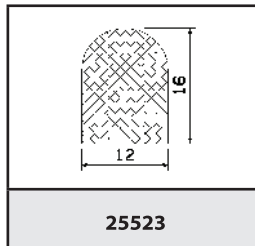

25523

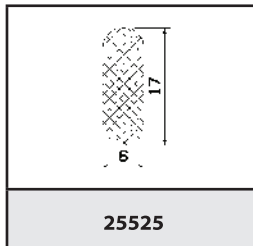

25525

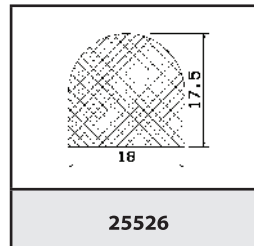

25526

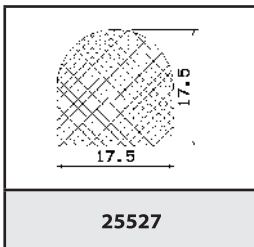

25527

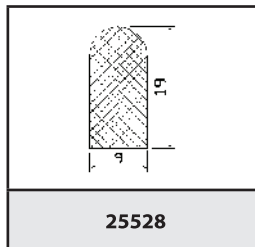

25528

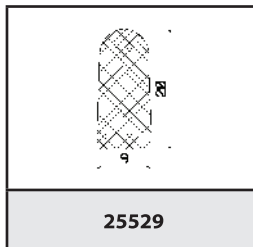

25529

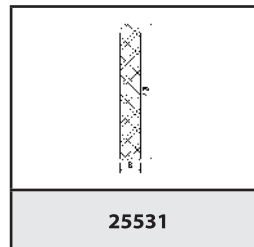

25531

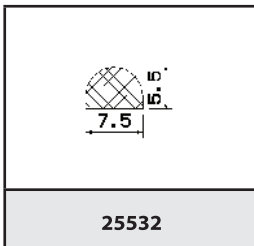

25532

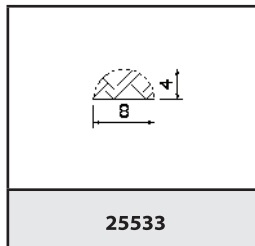

25533

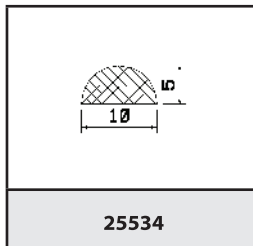

25534

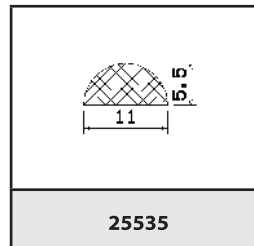

25535

○ mikroporézni, mikroporézni/silikonové ● gumové, silikonové

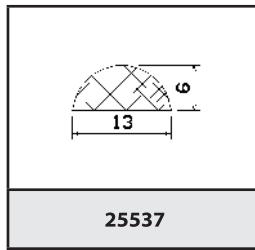

25537

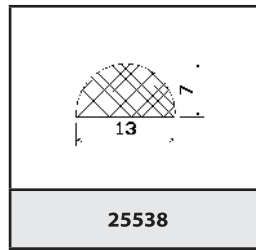

25538

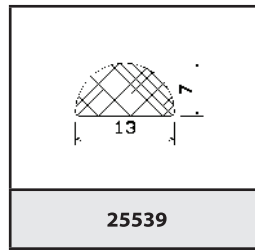

25539

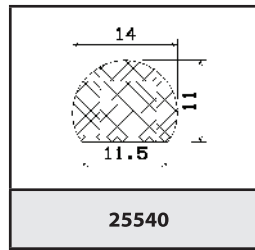

25540

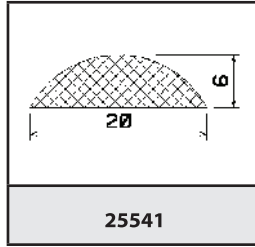

25541

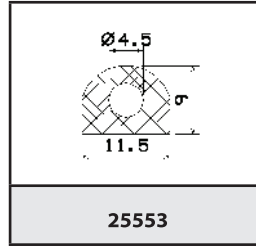

25553

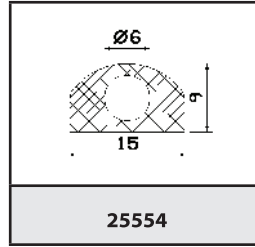

25554

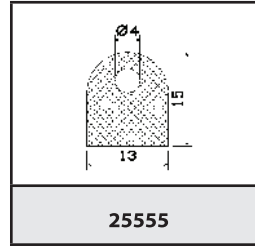

25555

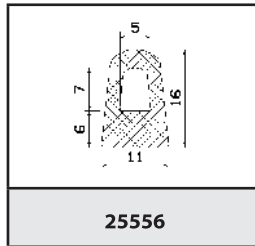

25556

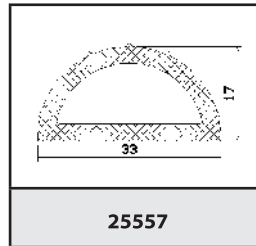

25557

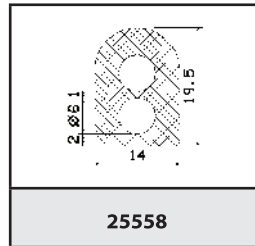

25558

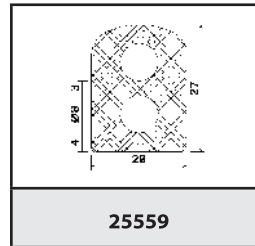

25559

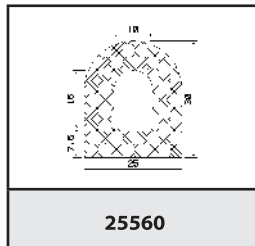

25560

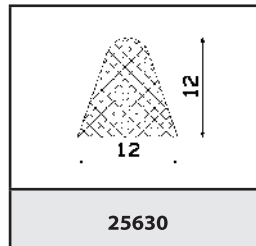

25630

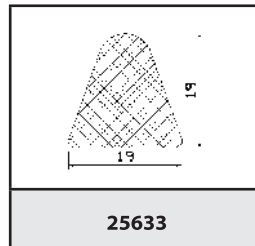

25633

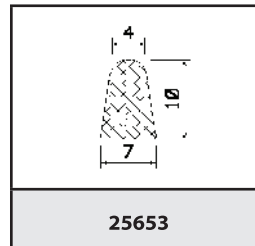

25653

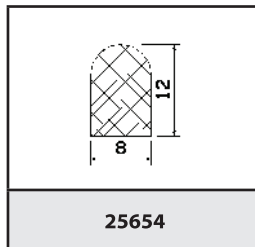

25654

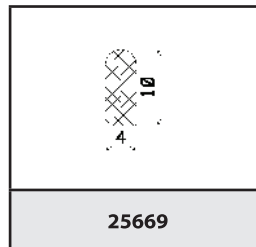

25669

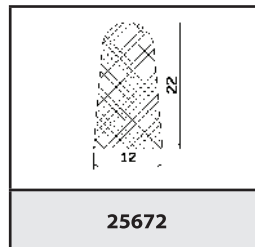

25672

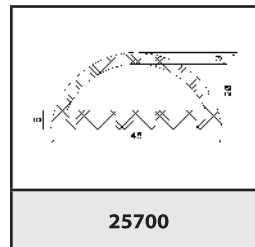

25700

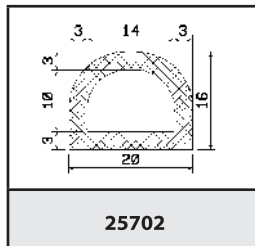

25702

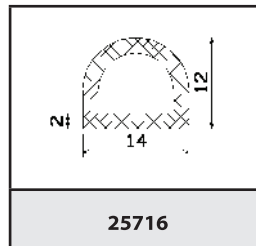

25716

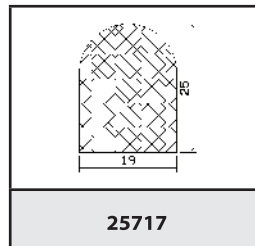

25717

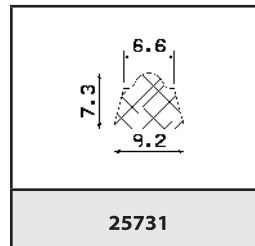

25731

○ mikroporézní, mikroporézní/silikonové ● gumové, silikonové

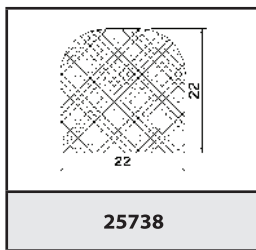

25738

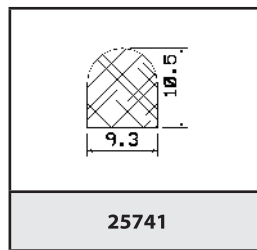

25741

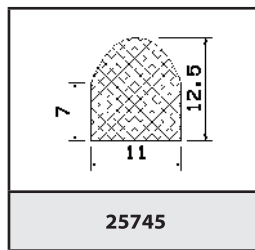

25745

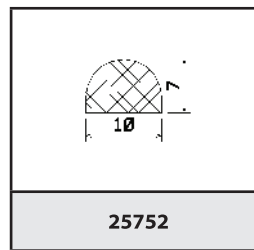

25752

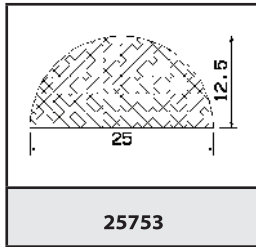

25753

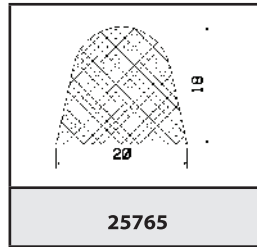

25765

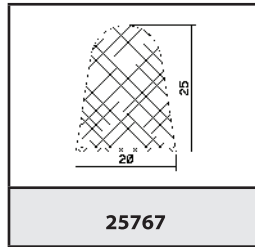

25767

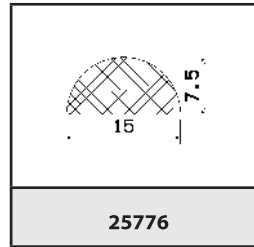

25776

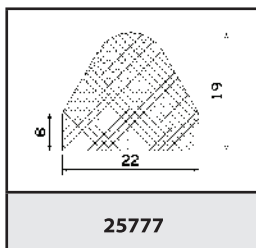

25777

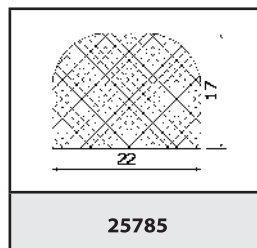

25785

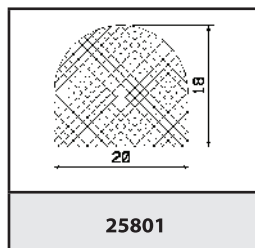

25801

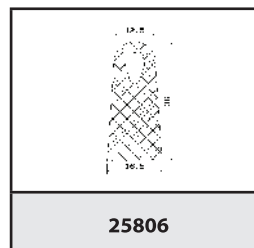

25806

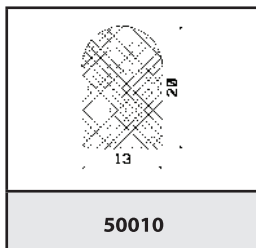

50010

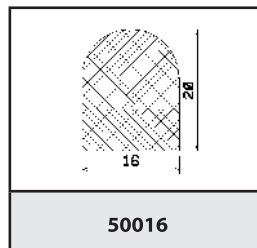

50016

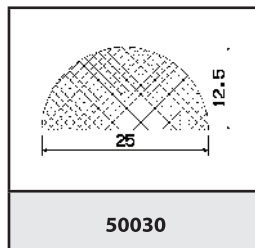

50030

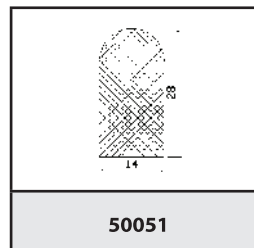

50051

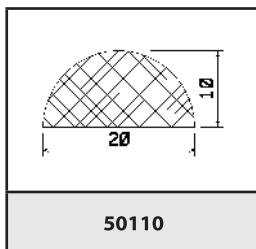

50110

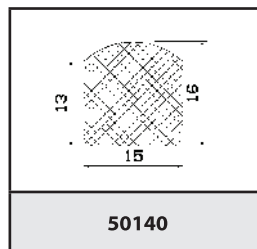

50140

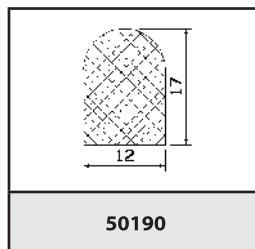

50190

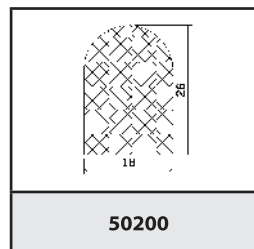

50200

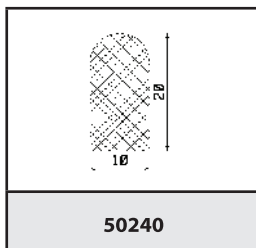

50240

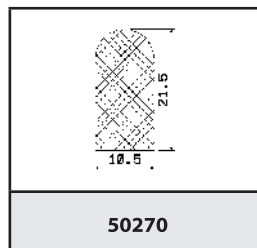

50270

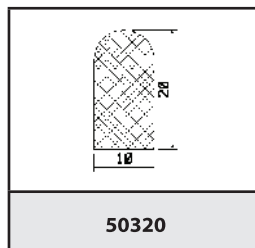

50320

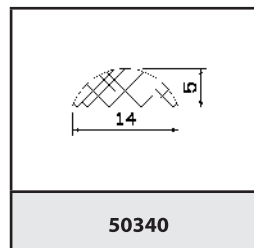

50340

○ mikroporézni, mikroporézni/silikonové ● gumové, silikonové

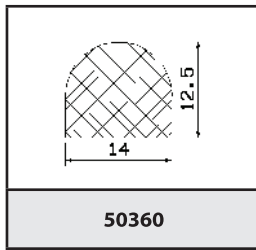

50360

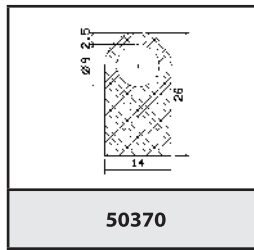

50370

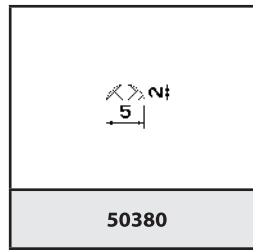

50380

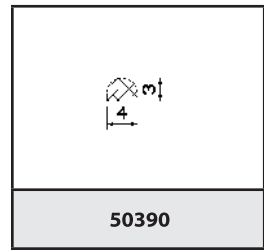

50390

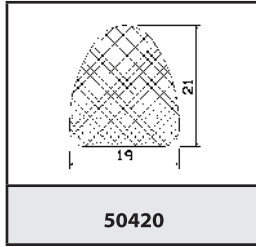

50420

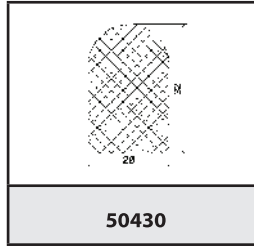

50430

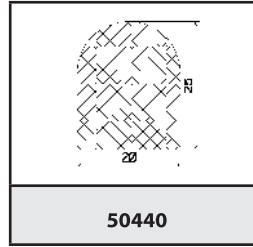

50440

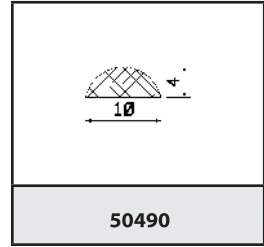

50490

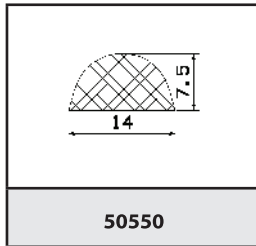

50550

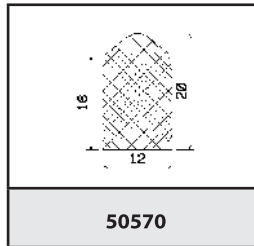

50570

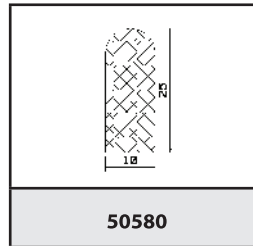

50580

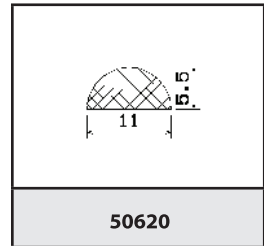

50620

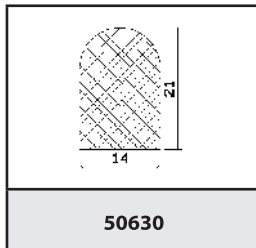

50630

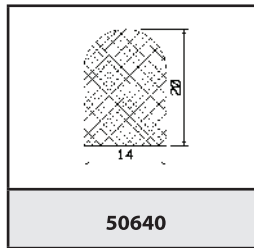

50640

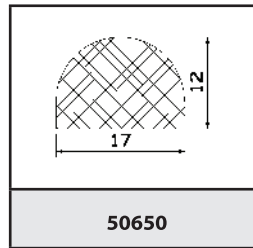

50650

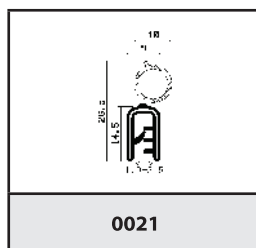

0021

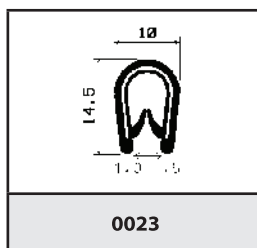

0023

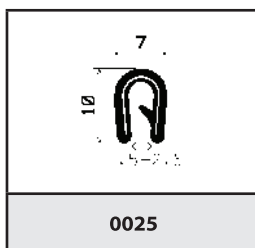

0025

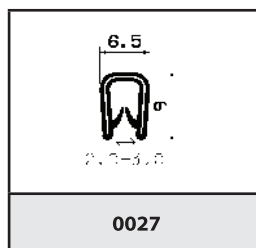

0027

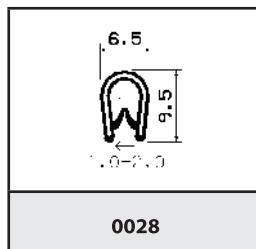

0028

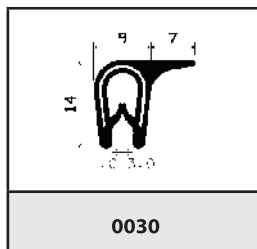

0030

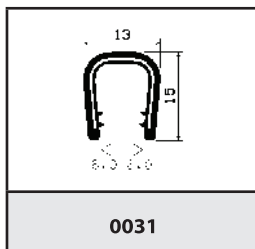

0031

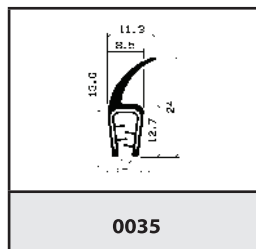

0035

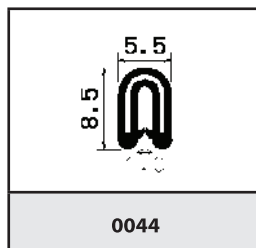

0044

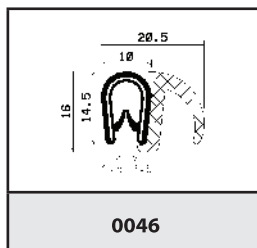

0046

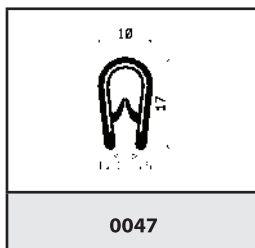

0047

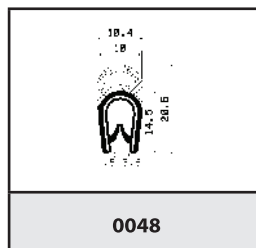

0048

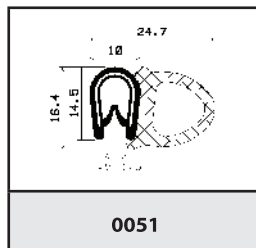

0051

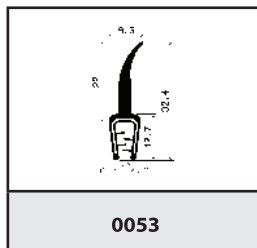

0053

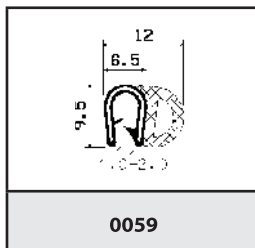

0059

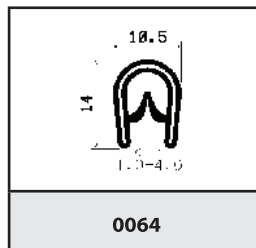

0064

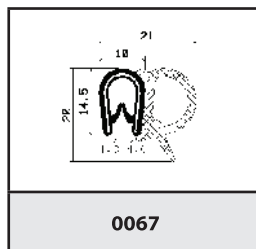

0067

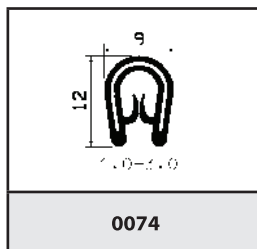

0074

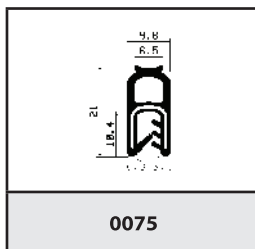

0075

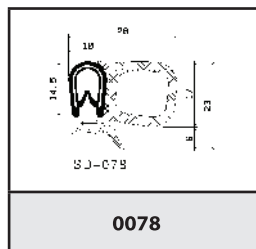

0078

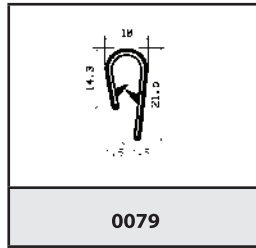

0079

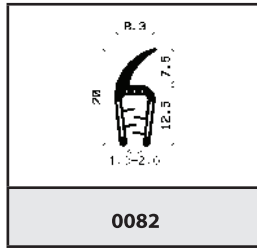

0082

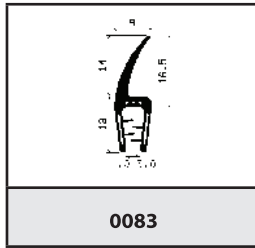

0083

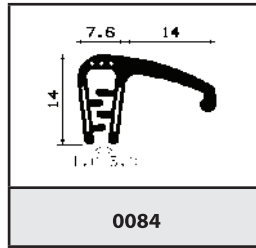

0084

○ mikroporézni, mikroporézni/silikonové ● gumové, silikonové

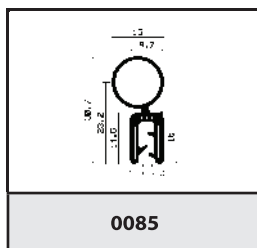

0085

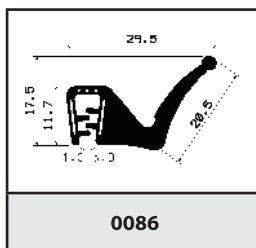

0086

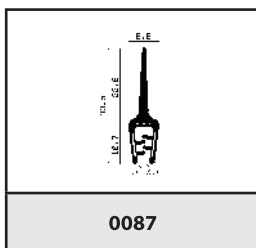

0087

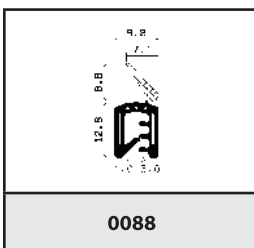

0088

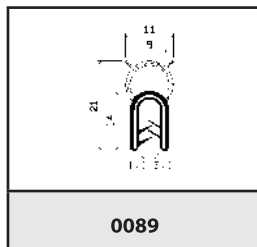

0089

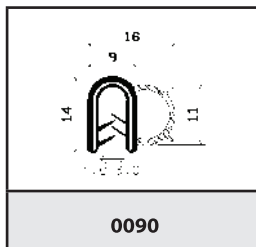

0090

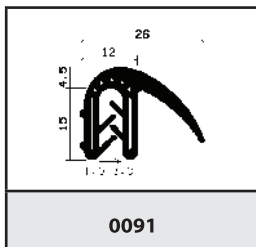

0091

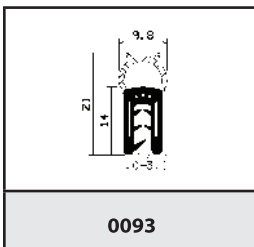

0093

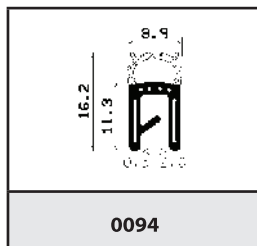

0094

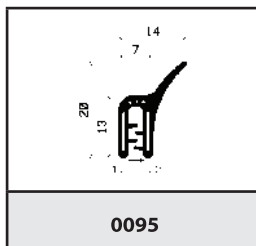

0095

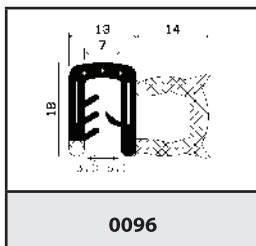

0096

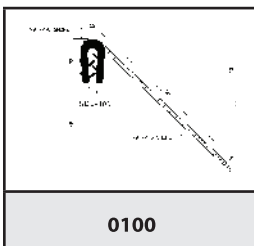

0100

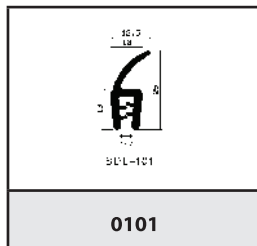

0101

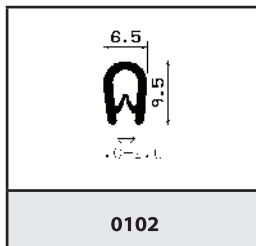

0102

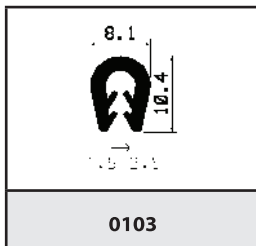

0103

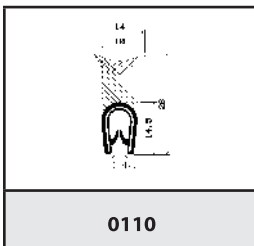

0110

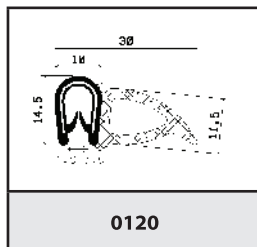

0120

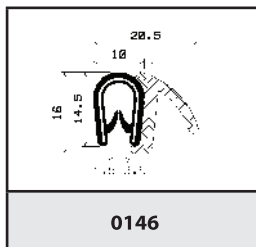

0146

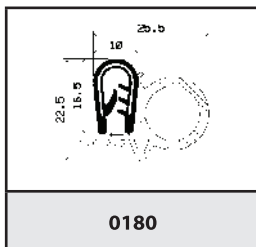

0180

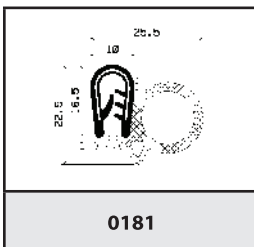

0181

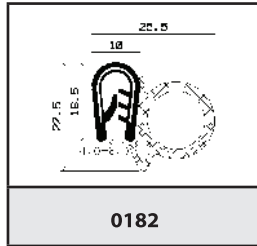

0182

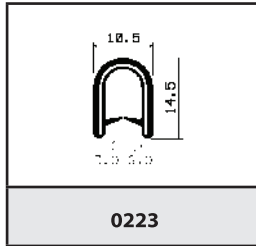

0223

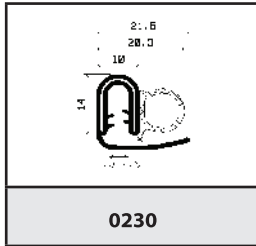

0230

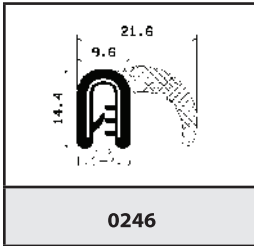

0246

○ mikroporézní, mikroporézní/silikonové ● gumové, silikonové

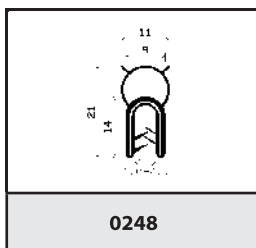

0248

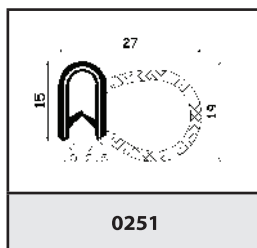

0251

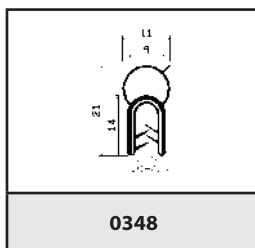

0348

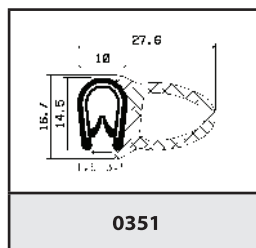

0351

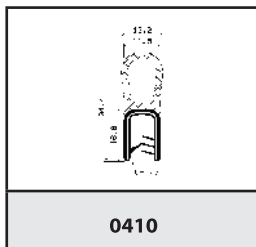

0410

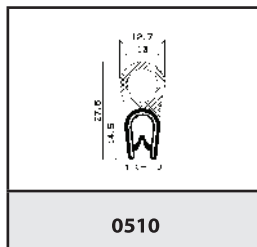

0510

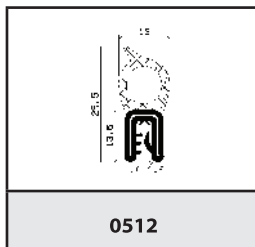

0512

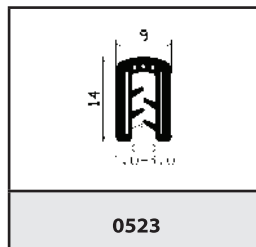

0523

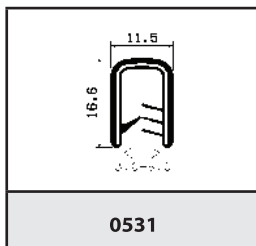

0531

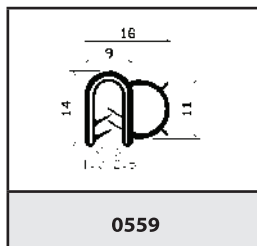

0559



0570

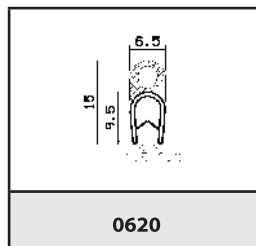

0620

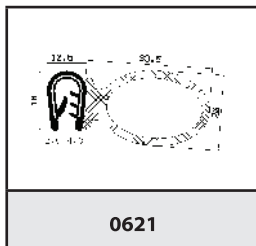

0621

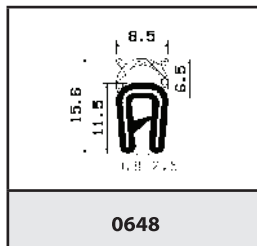

0648

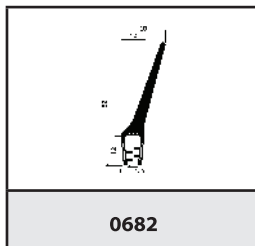

0682

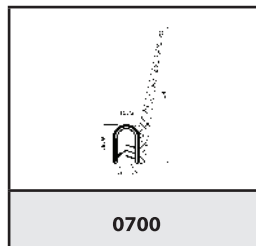

0700

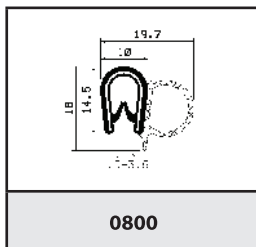

0800

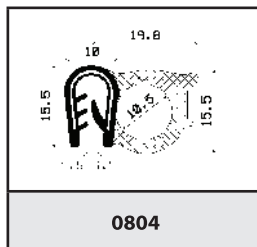

0804

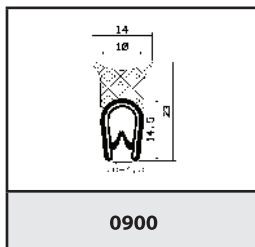

0900

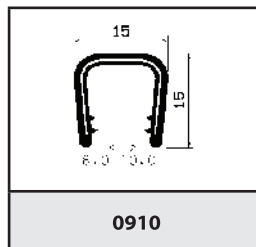

0910

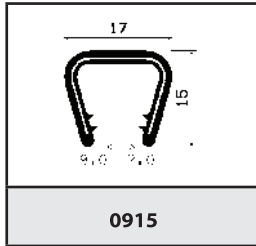

0915

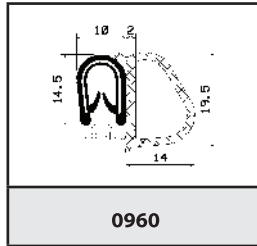

0960

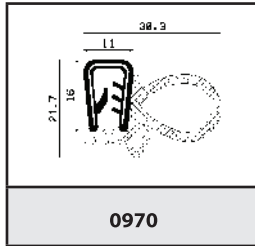

0970

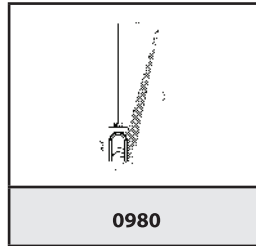

0980

○ mikroporézni, mikroporézni/silikonové ● gumové, silikonové

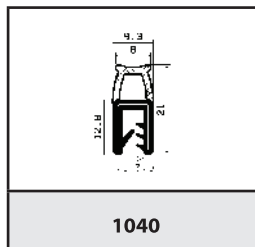
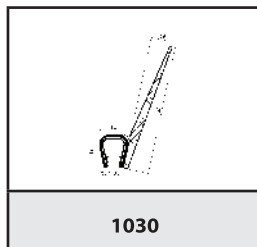
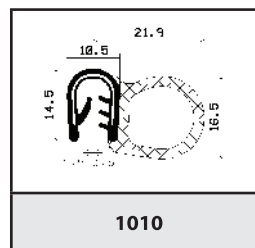
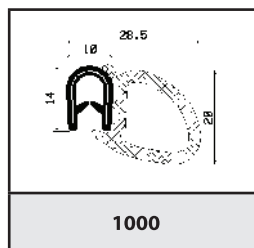
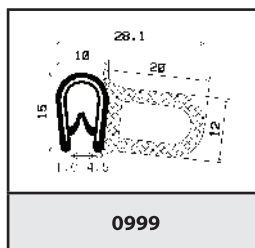
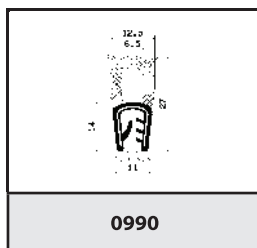

○ mikroporézní, mikroporézní/silikonové ● gumové, silikonové

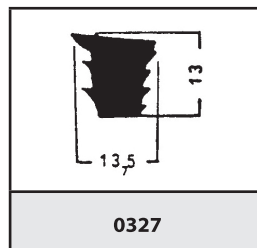
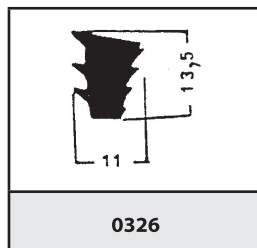
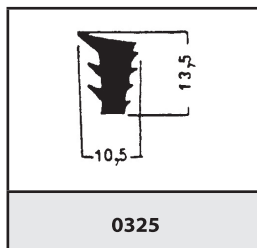
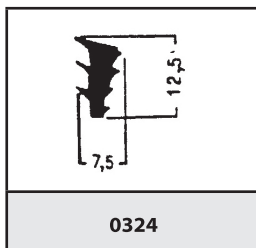
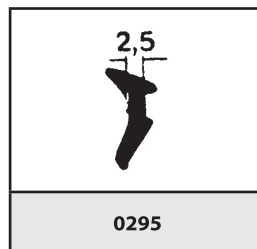
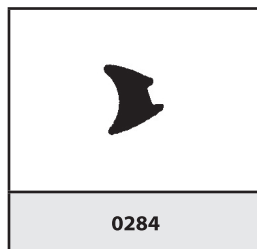
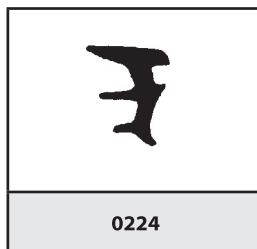
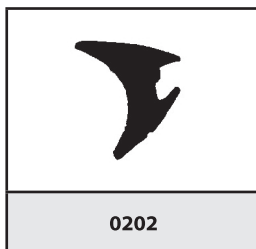
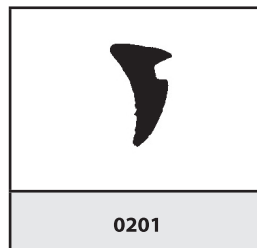
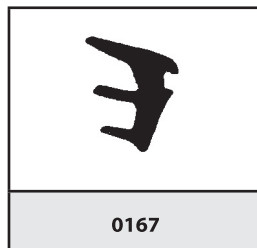
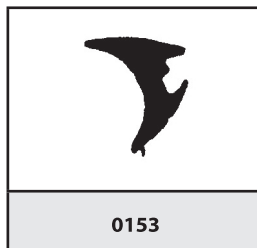
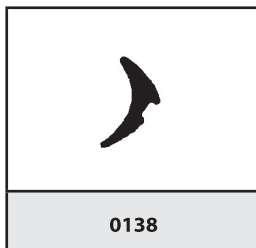
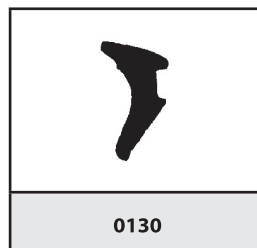
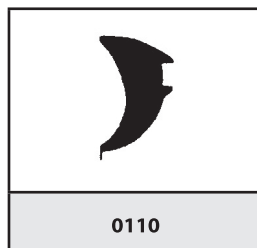
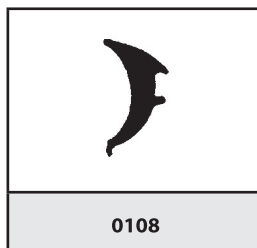
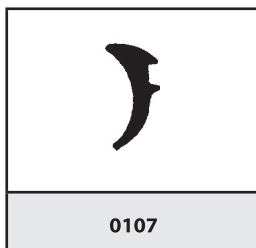
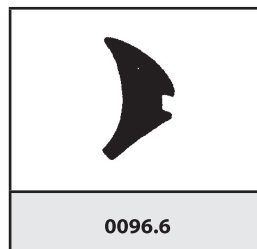
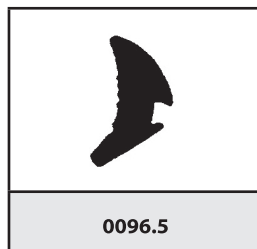
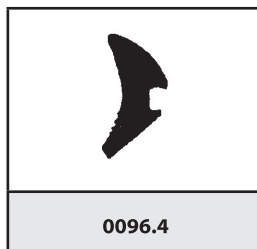
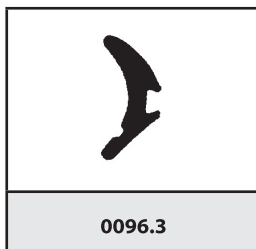
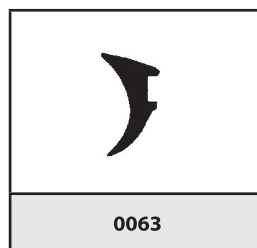
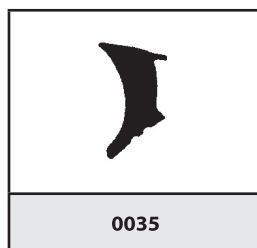
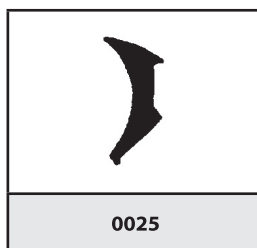
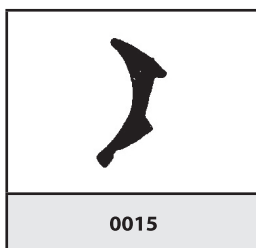

○ mikroporézní, mikroporézní/silikonové ● gumové, silikonové

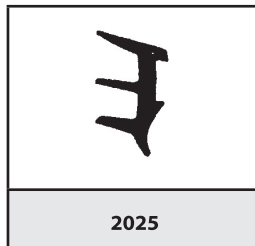
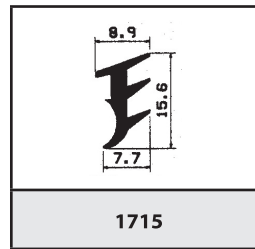
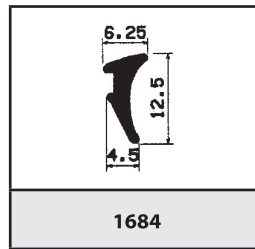
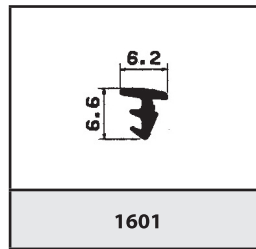
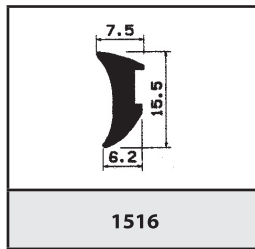
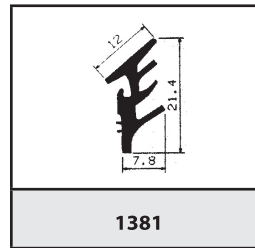
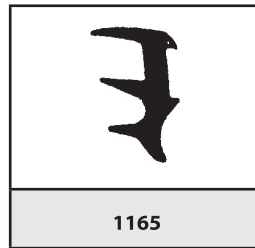
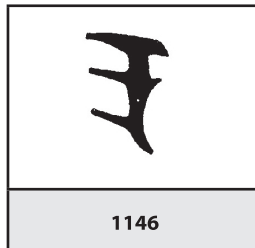
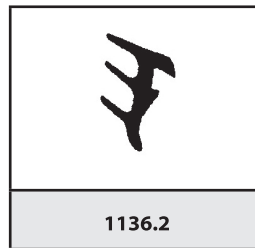
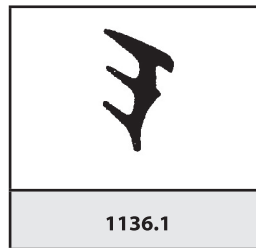
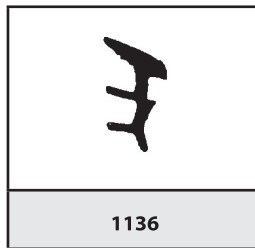
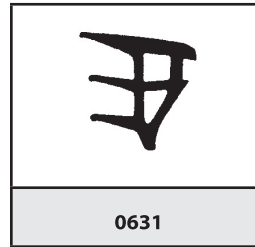
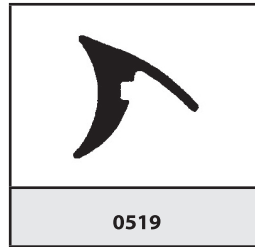
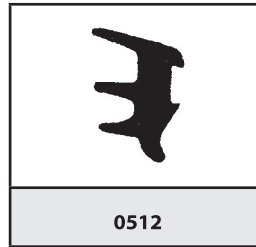
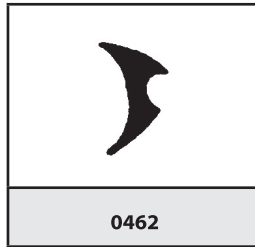
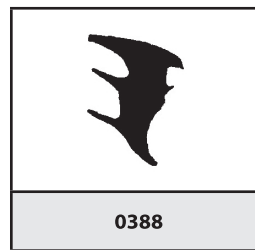
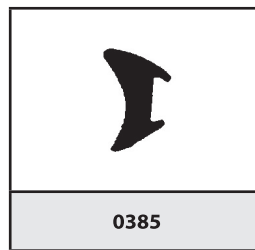
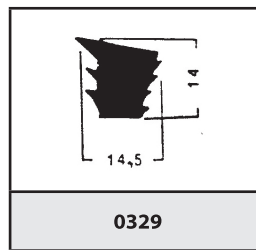
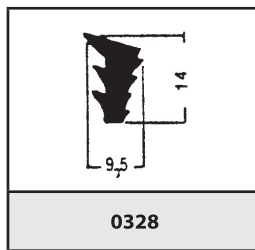

○ mikroporézní, mikroporézní/silikonové ● gumové, silikonové

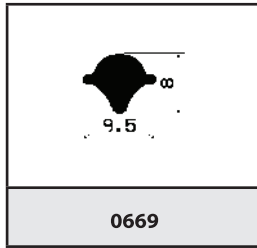
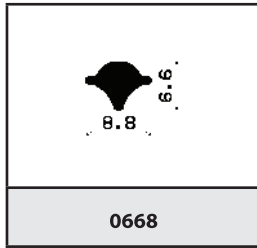
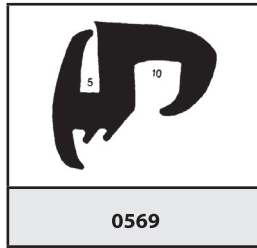
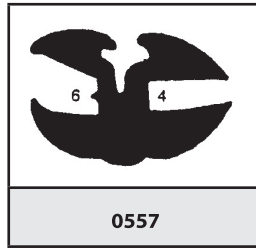
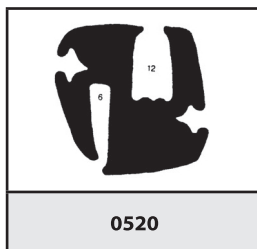
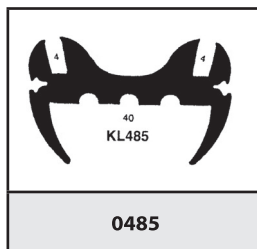
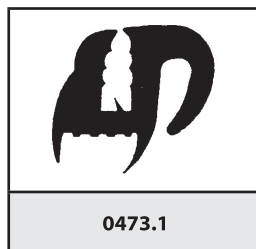
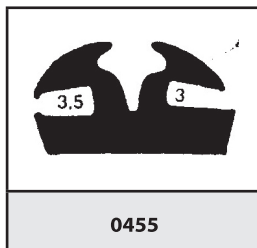
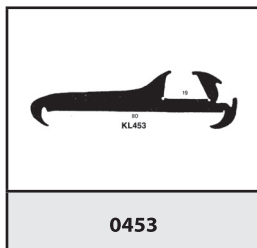
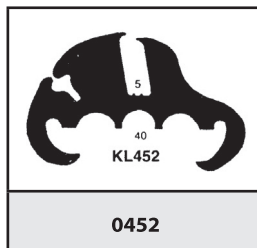
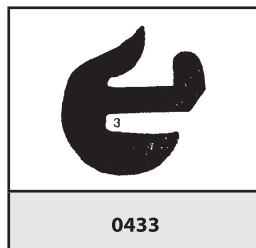
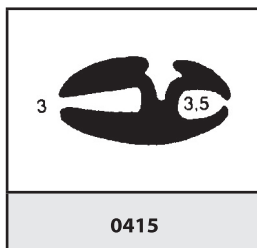
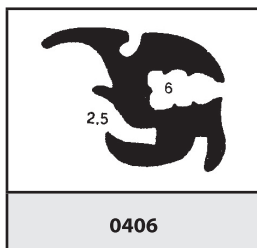
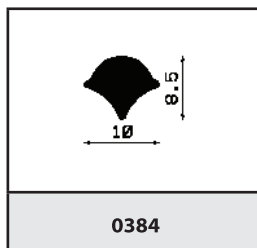
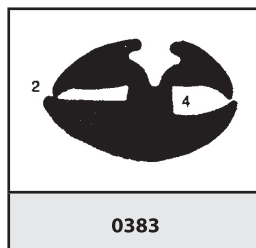
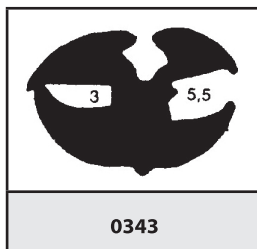
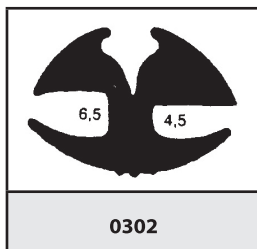
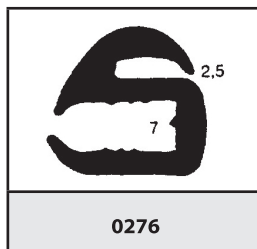
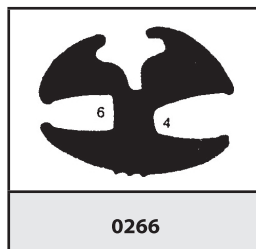
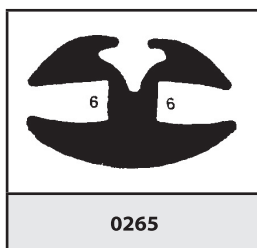
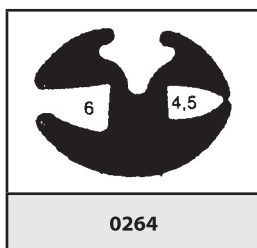
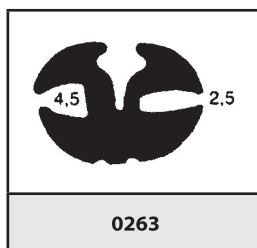
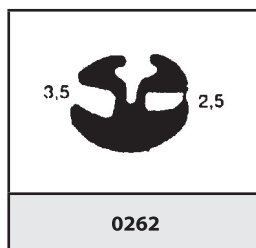

○ mikroporézní, mikroporézní/silikonové ● gumové, silikonové

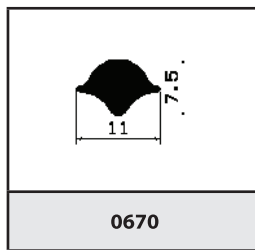

0670

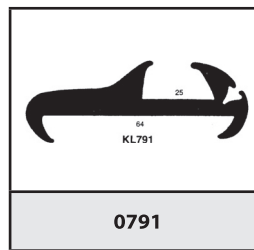

0791

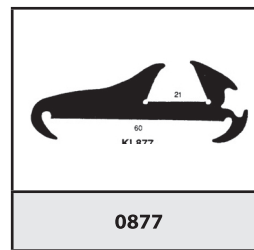

0877

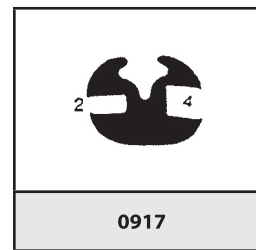

0917

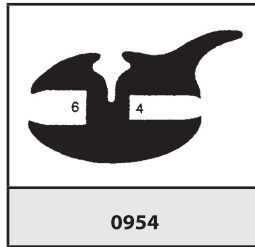

0954

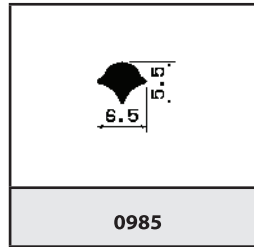

0985

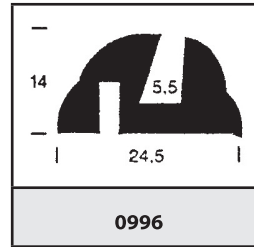

0996

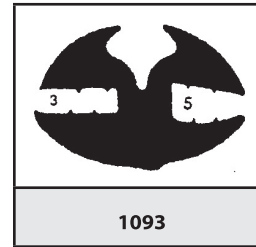

1093

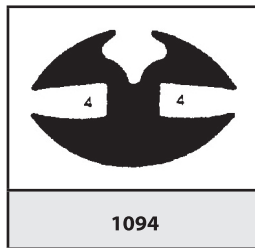

1094

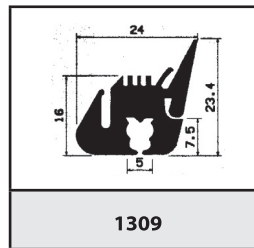

1309

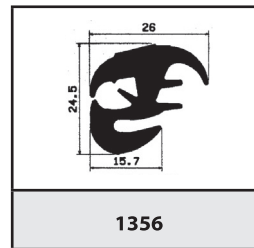

1356

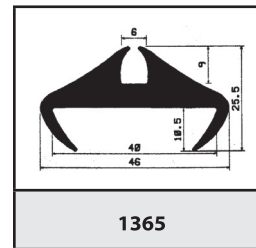

1365

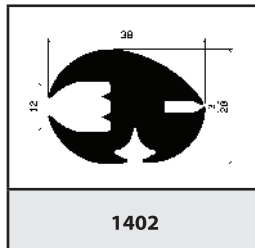

1402

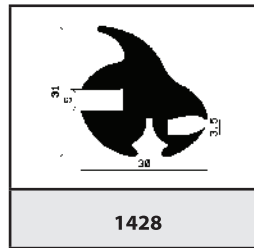

1428

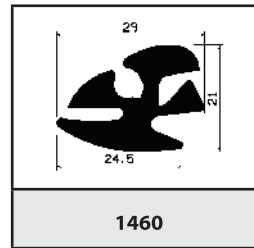

1460

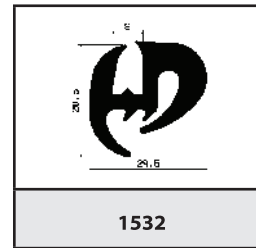

1532

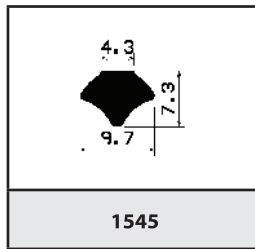

1545

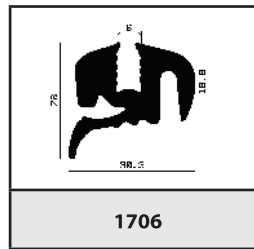

1706

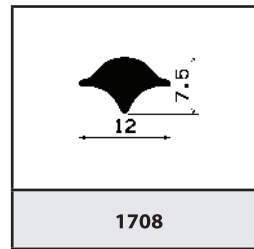

1708

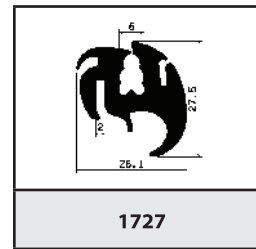

1727

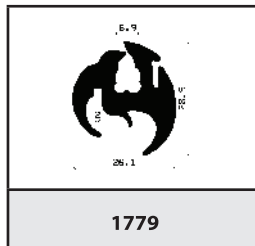

1779

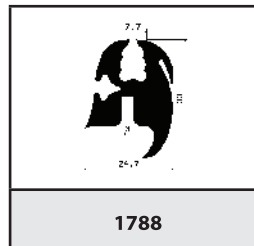

1788



1792

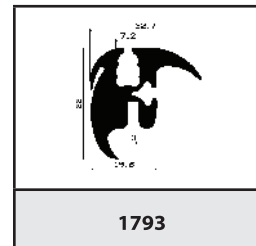

1793

○ mikroporézní, mikroporézní/silikonové ● gumové, silikonové

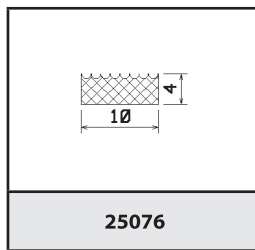

25076

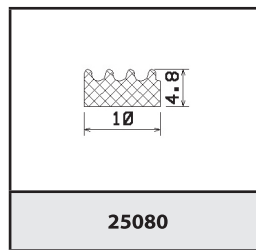

25080

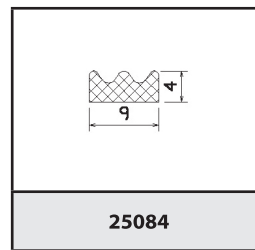

25084

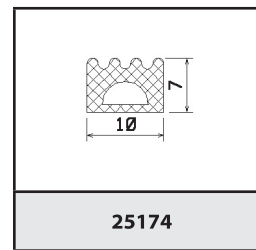

25174

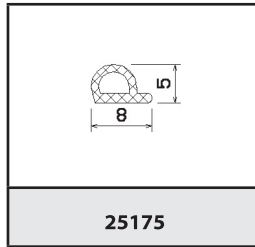

25175

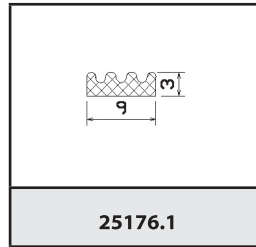

25176.1

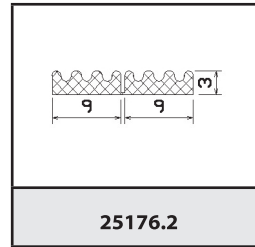

25176.2

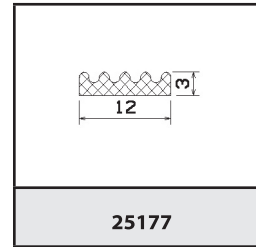

25177

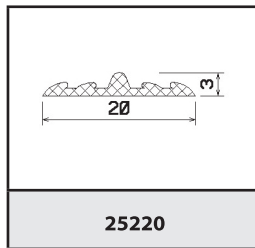

25220

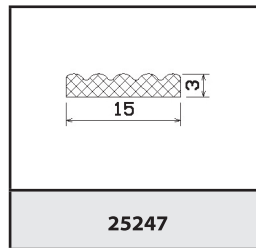

25247

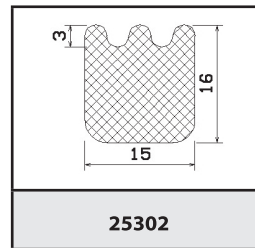

25302

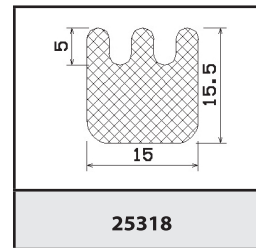

25318

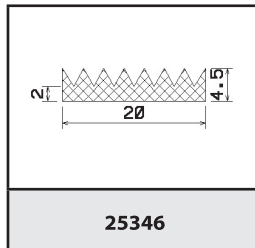

25346

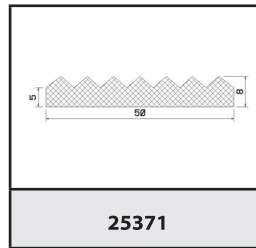

25371

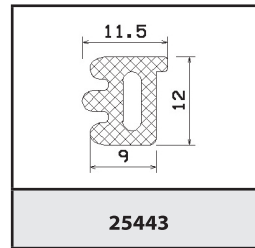

25443

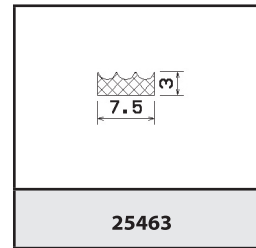

25463

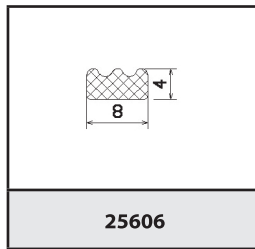

25606

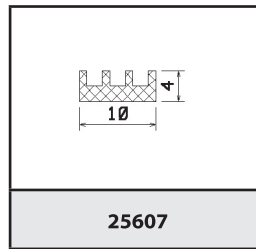

25607

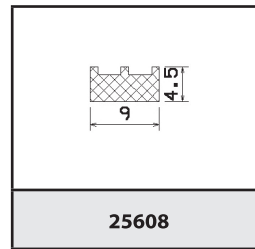

25608

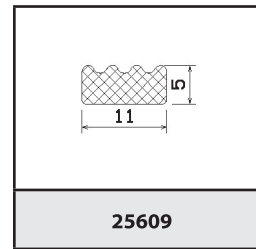

25609

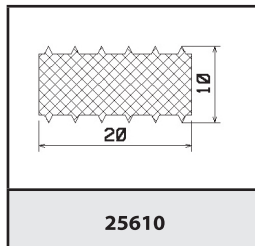

25610

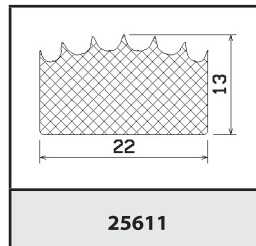

25611

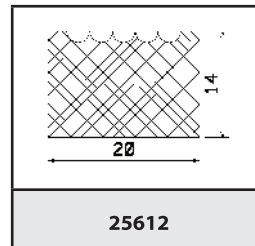

25612

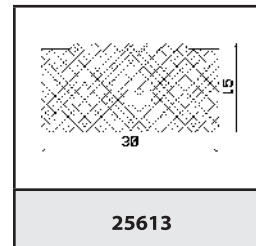

25613

○ mikroporézní, mikroporézní/silikonové ● gumové, silikonové

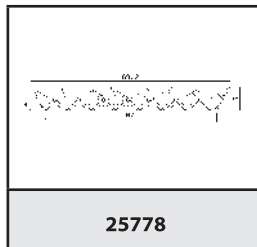
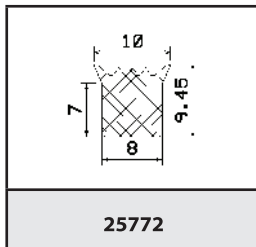
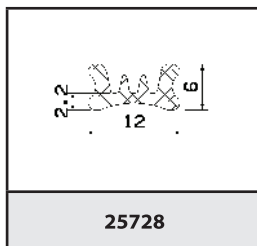
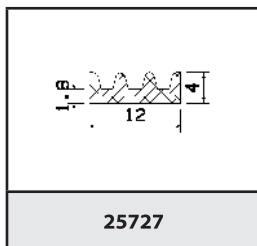
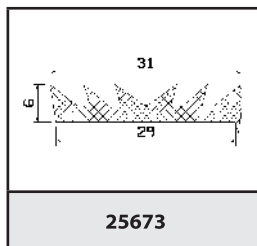
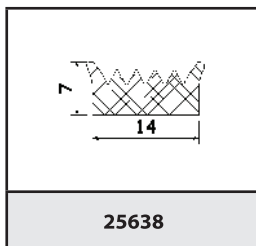

○ mikroporézní, mikroporézní/silikonové ● gumové, silikonové

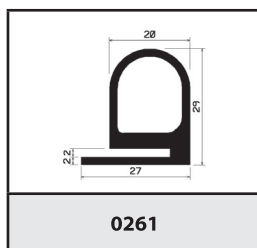

0261

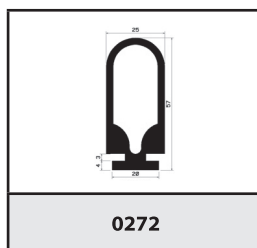

0272

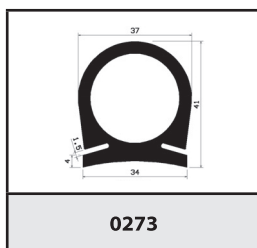

0273

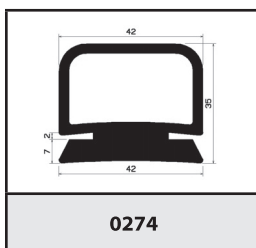

0274

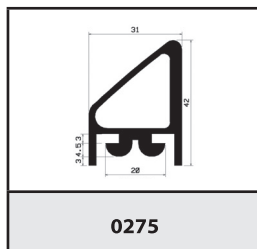

0275

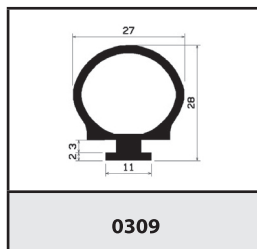

0309

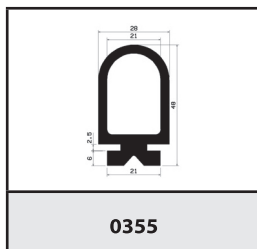

0355

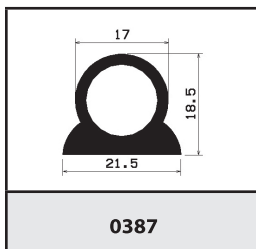

0387

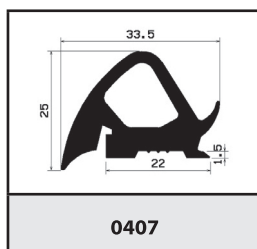

0407

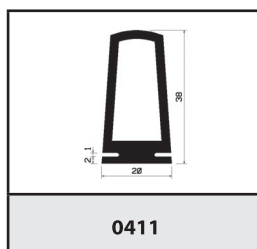

0411

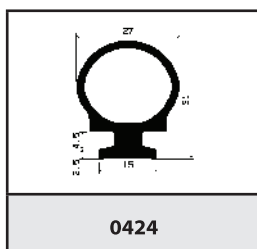

0424

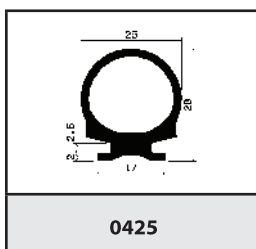

0425

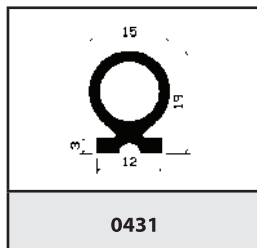

0431

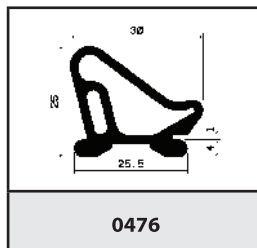

0476

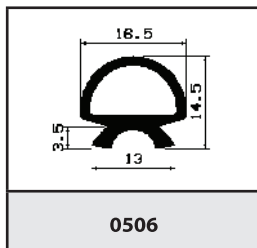

0506

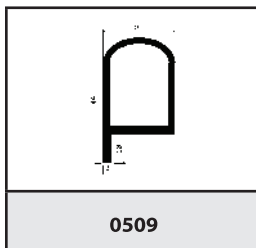

0509

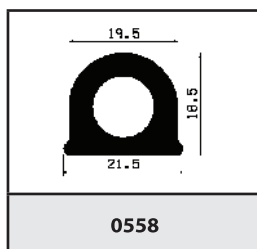

0558

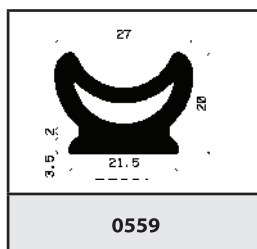

0559

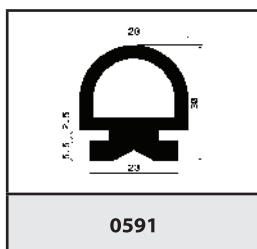

0591

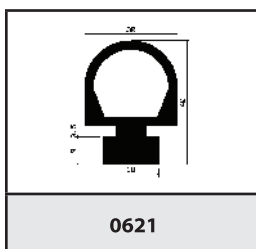

0621

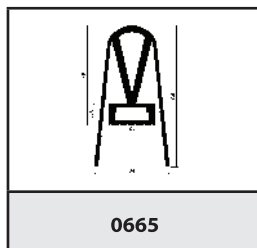

0665

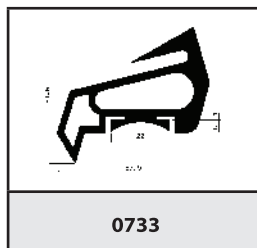

0733

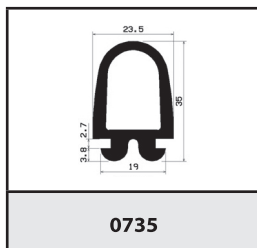

0735

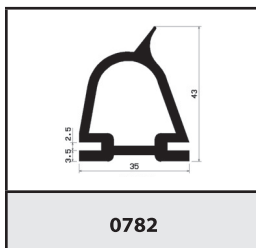

0782

○ mikroporézní, mikroporézní/silikonové ● gumové, silikonové

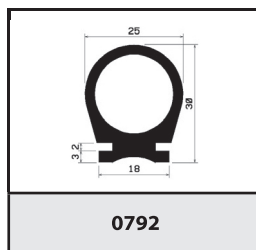

0792

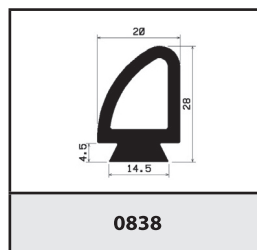

0838

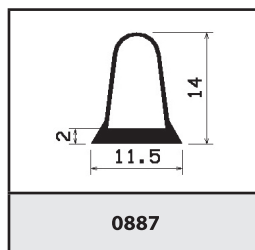

0887

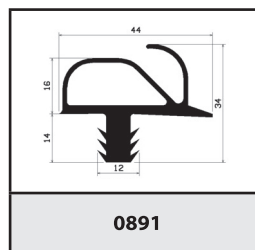

0891

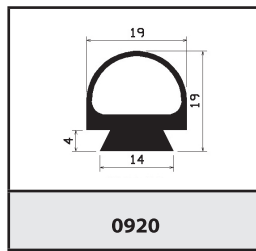

0920

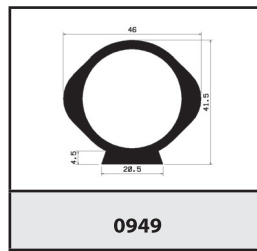

0949

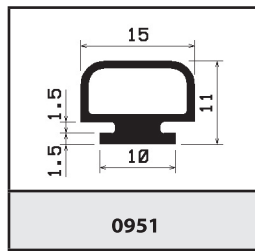

0951

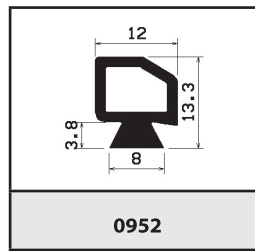

0952

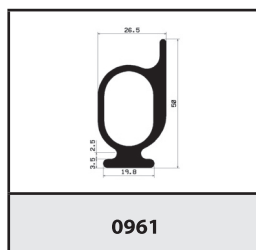

0961

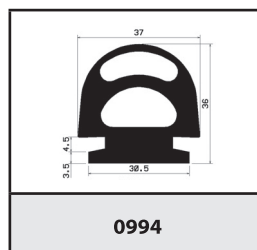

0994

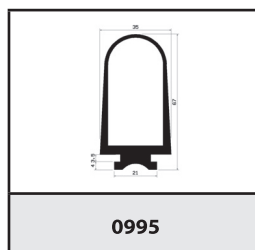

0995

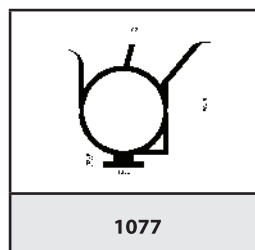

1077

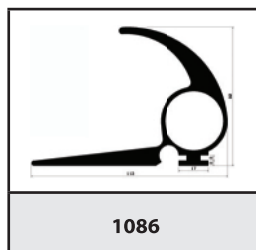

1086

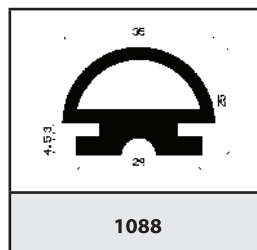

1088

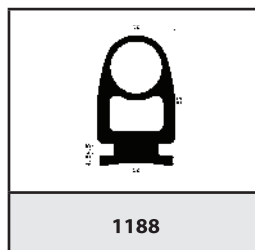

1188

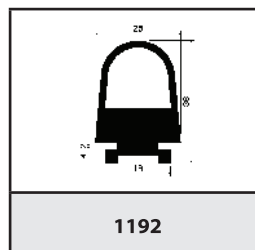

1192

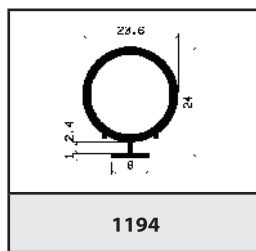

1194

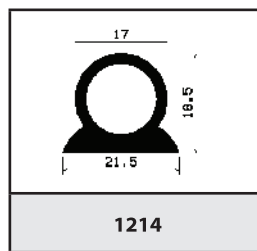

1214

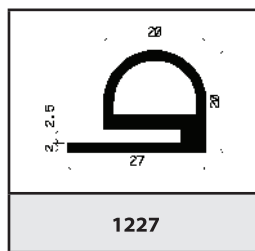

1227

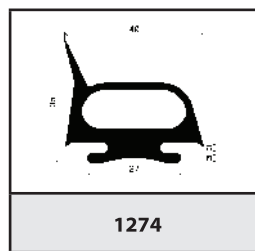

1274

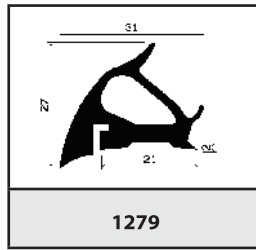

1279

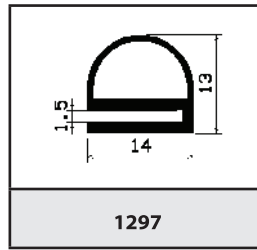

1297

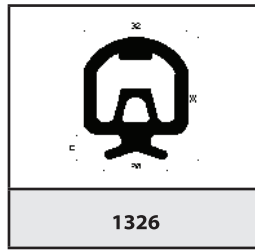

1326

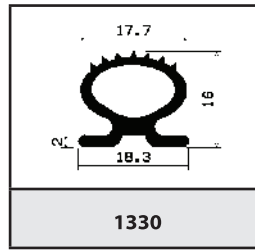

1330

○ mikroporézni, mikroporézni/silikonové ● gumové, silikonové

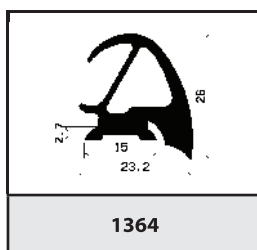

1364

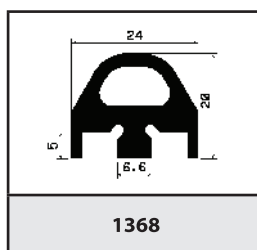

1368

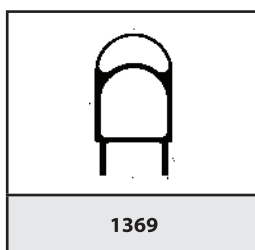

1369

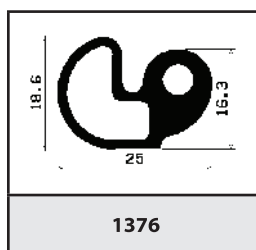

1376

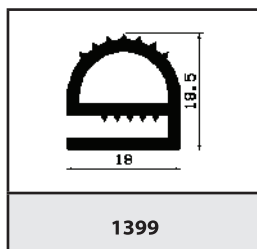

1399

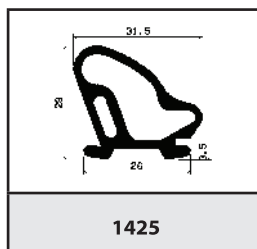

1425

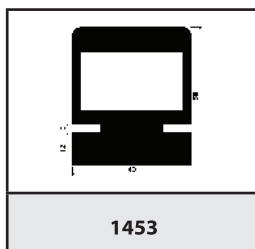

1453

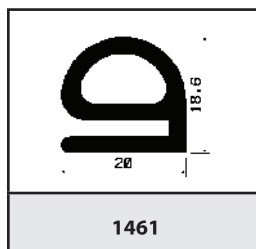

1461

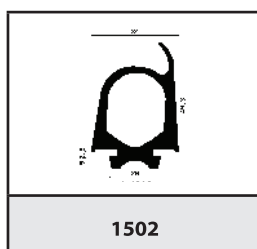

1502

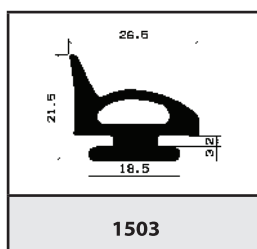

1503

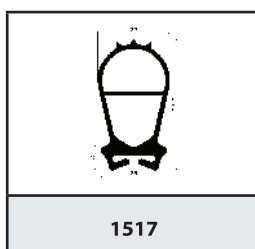

1517

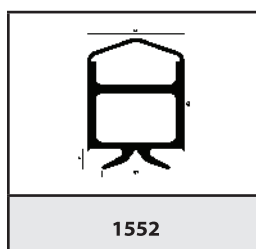

1552

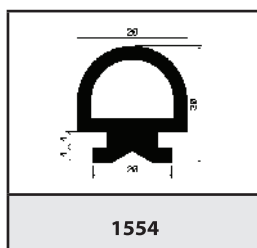

1554

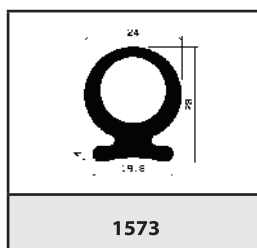

1573

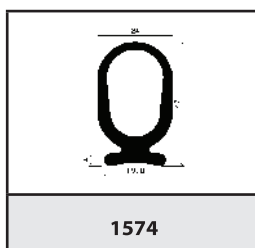

1574

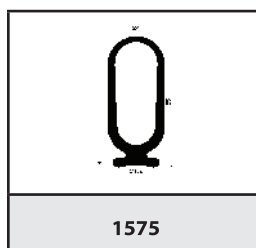

1575

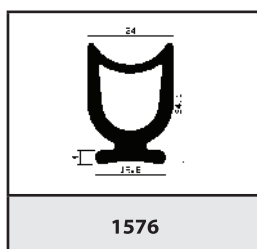

1576

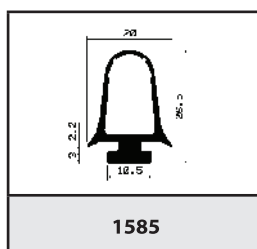

1585

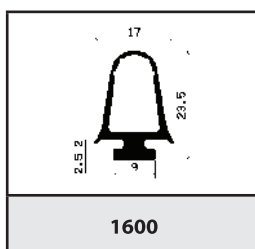

1600

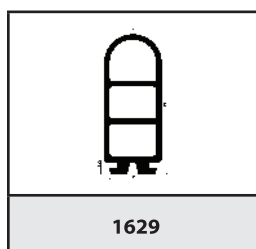

1629

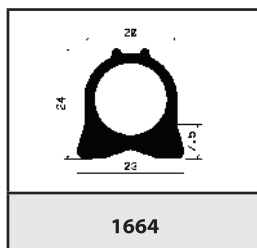

1664

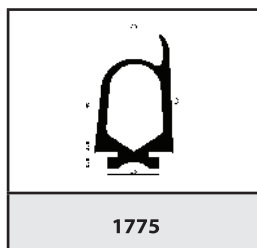

1775

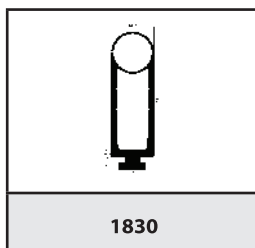

1830

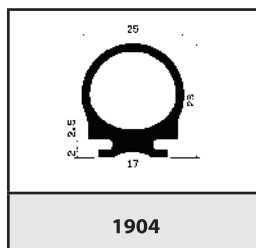

1904

○ mikroporézní, mikroporézní/silikonové ● gumové, silikonové

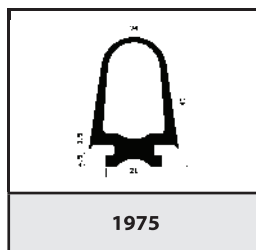

1975

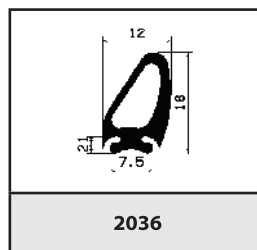

2036

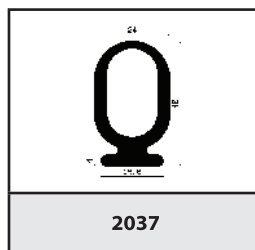

2037

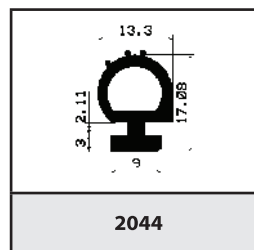

2044

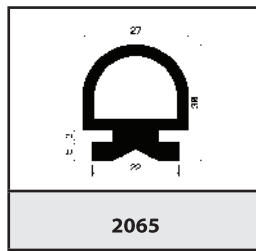

2065

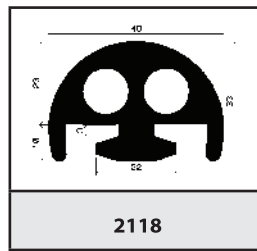

2118

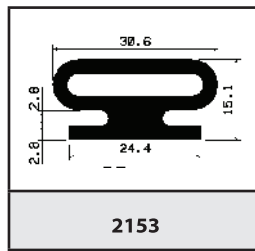

2153

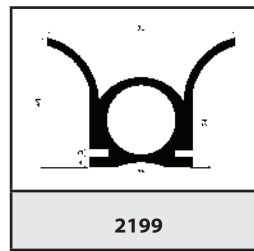

2199

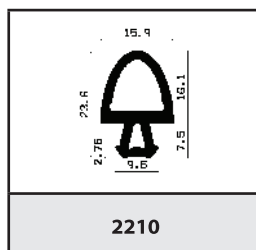

2210

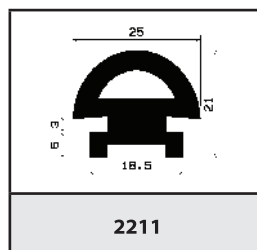

2211

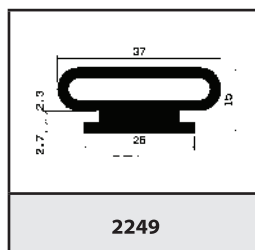

2249

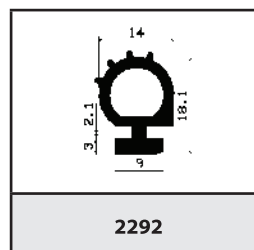

2292

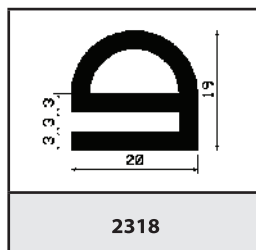

2318

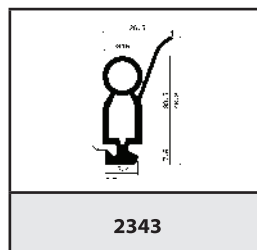

2343

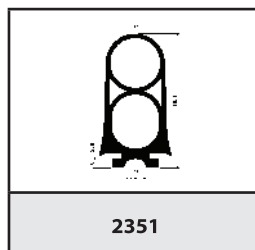

2351

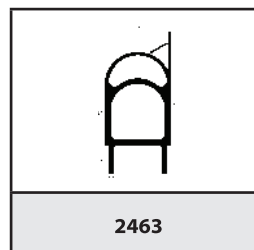

2463

○ mikroporézní, mikroporézní/silikonové ● gumové, silikonové

gumové (EPDM, CR, NBR, NR)	mikroporézní (EPDM, CR)	silikonové		silikonové mikroporézní
Ø 01,00mm	Ø 01,00mm	Ø 00,60mm	Ø 12,00mm	Ø 01,00mm
Ø 01,50mm	Ø 01,50mm	Ø 01,00mm	Ø 12,50mm	Ø 01,50mm
Ø 01,55mm	Ø 02,00mm	Ø 01,50mm	Ø 13,00mm	Ø 02,00mm
Ø 01,60mm	Ø 02,50mm	Ø 01,55mm	Ø 13,50mm	Ø 02,50mm
Ø 01,78mm	Ø 02,80mm	Ø 01,60mm	Ø 14,00mm	Ø 03,00mm
Ø 02,00mm	Ø 03,00mm	Ø 01,78mm	Ø 14,50mm	Ø 03,50mm
Ø 02,50mm	Ø 03,50mm	Ø 01,80mm	Ø 15,00mm	Ø 04,00mm
Ø 02,62mm	Ø 04,00mm	Ø 02,00mm	Ø 15,50mm	Ø 04,50mm
Ø 03,00mm	Ø 04,50mm	Ø 02,40mm	Ø 16,00mm	Ø 05,00mm
Ø 03,20mm	Ø 05,00mm	Ø 02,50mm	Ø 16,50mm	Ø 05,50mm
Ø 03,50mm	Ø 05,80mm	Ø 02,62mm	Ø 17,00mm	Ø 06,00mm
Ø 04,00mm	Ø 06,00mm	Ø 03,00mm	Ø 17,50mm	Ø 06,50mm
Ø 04,50mm	Ø 06,50mm	Ø 03,20mm	Ø 18,00mm	Ø 07,00mm
Ø 05,00mm	Ø 07,00mm	Ø 03,35mm	Ø 18,50mm	Ø 08,00mm
Ø 05,33mm	Ø 07,50mm	Ø 03,50mm	Ø 19,00mm	Ø 12,00mm
Ø 05,50mm	Ø 08,00mm	Ø 04,00mm	Ø 19,50mm	Ø 15,00mm
Ø 05,70mm	Ø 09,60mm	Ø 04,50mm	Ø 20,00mm	Ø 18,00mm
Ø 06,00mm	Ø 10,00mm	Ø 05,00mm	Ø 20,50mm	Ø 20,00mm
Ø 06,50mm	Ø 11,00mm	Ø 05,33mm	Ø 21,00mm	Ø 22,00mm
Ø 06,60mm	Ø 12,00mm	Ø 05,50mm	Ø 21,50mm	Ø 25,00mm
Ø 07,00mm	Ø 13,00mm	Ø 05,70mm	Ø 22,00mm	Ø 30,00mm
Ø 07,50mm	Ø 13,50mm	Ø 06,00mm	Ø 22,50mm	Ø 32,00mm
Ø 08,00mm	Ø 14,00mm	Ø 06,35mm	Ø 23,00mm	Ø 35,00mm
Ø 08,50mm	Ø 15,00mm	Ø 06,50mm	Ø 23,50mm	Ø 40,00mm
Ø 09,00mm	Ø 16,00mm	Ø 07,00mm	Ø 24,00mm	Ø 43,00mm
Ø 10,00mm	Ø 16,50mm	Ø 07,50mm	Ø 24,50mm	Ø 45,00mm
Ø 11,00mm	Ø 17,00mm	Ø 08,00mm	Ø 25,00mm	Ø 50,00mm
Ø 12,00mm	Ø 18,00mm	Ø 08,50mm	Ø 30,00mm	Ø 60,00mm
Ø 13,00mm	Ø 19,00mm	Ø 09,00mm	Ø 30,00mm	
Ø 14,00mm	Ø 20,00mm	Ø 09,50mm	Ø 35,00mm	
Ø 15,00mm	Ø 22,00mm	Ø 10,00mm	Ø 38,00mm	
Ø 16,00mm	Ø 23,00mm	Ø 10,50mm	Ø 40,00mm	
Ø 17,00mm	Ø 25,00mm	Ø 11,00mm	Ø 45,00mm	
Ø 18,00mm	Ø 28,00mm	Ø 11,50mm	Ø 50,00mm	
Ø 19,00mm	Ø 30,00mm			
Ø 20,00mm	Ø 33,00mm			
Ø 22,00mm	Ø 35,00mm			
Ø 24,00mm	Ø 38,00mm			
Ø 25,00mm	Ø 40,00mm			
Ø 27,50mm	Ø 45,00mm			
Ø 30,00mm	Ø 48,00mm			
Ø 33,00mm	Ø 50,00mm			
Ø 35,00mm	Ø 52,50mm			
Ø 37,00mm	Ø 60,00mm			
Ø 40,00mm				
Ø 45,00mm				
Ø 50,00mm				

Uvedené rozměry lze dodat ve všech uvedených materiálech..

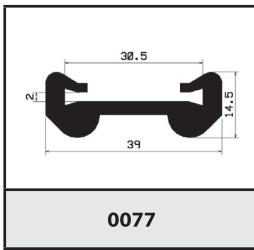

0077

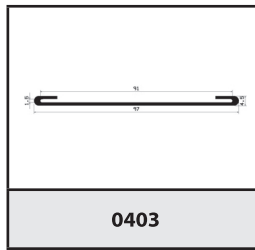

0403

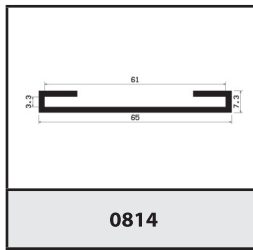

0814

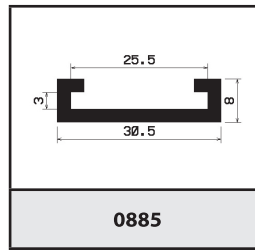

0885

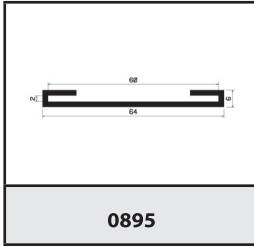

0895

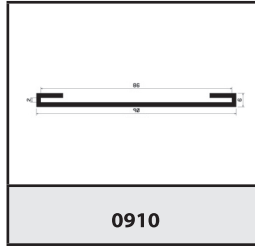

0910

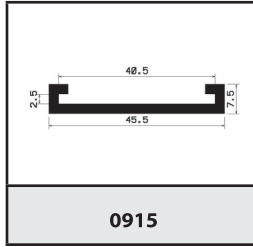

0915

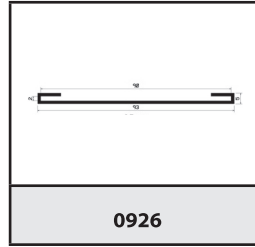

0926

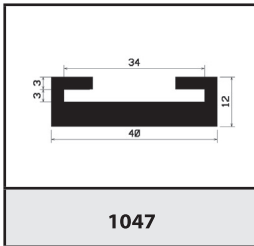

1047

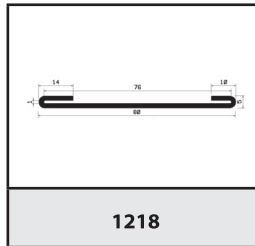

1218

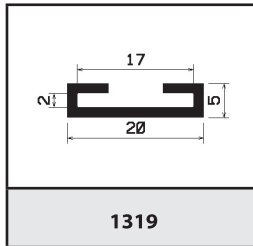

1319

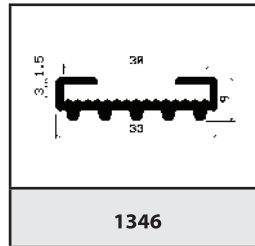

1346

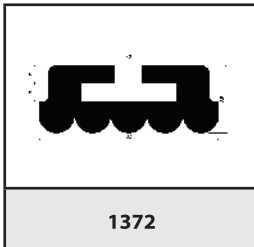

1372

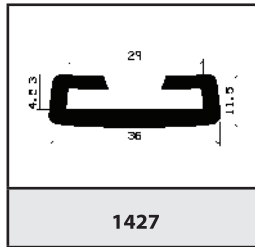

1427

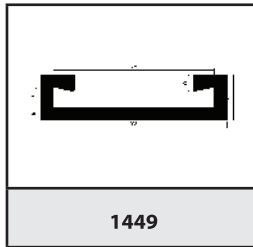

1449

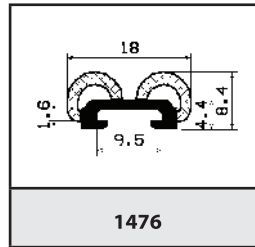

1476

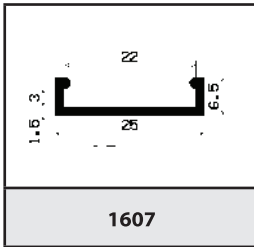

1607

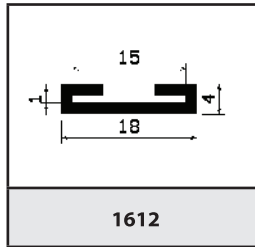

1612

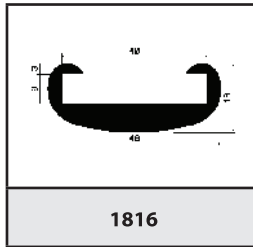

1816

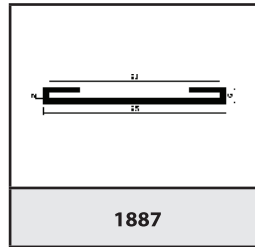

1887

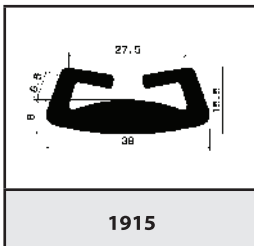

1915

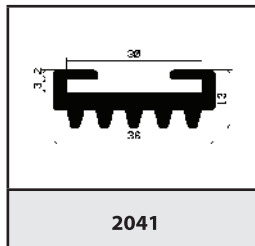

2041

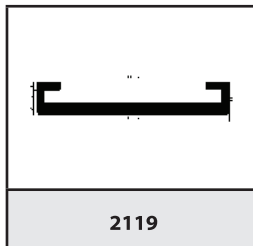

2119

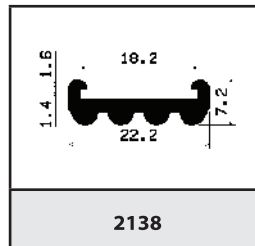

2138

○ mikroporézni, mikroporézni/silikonové ● gumové, silikonové

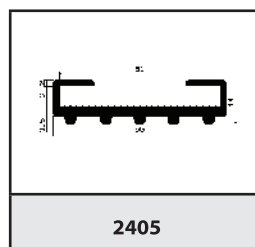
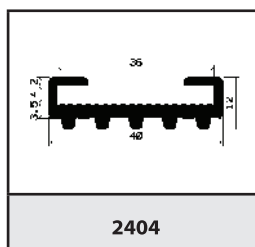
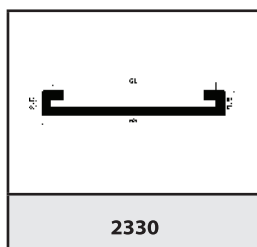
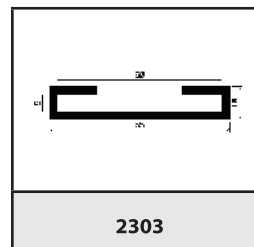
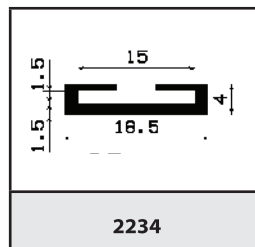
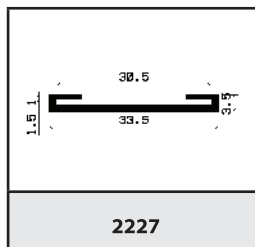
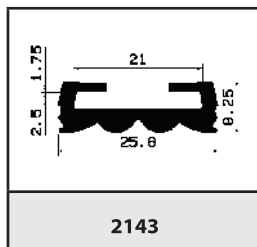
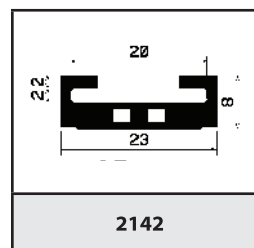
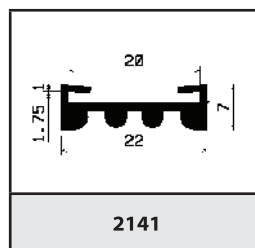
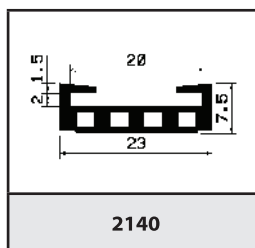
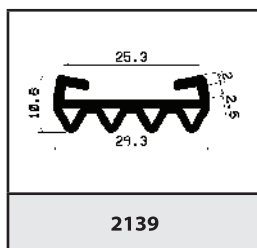

○ mikroporézní, mikroporézní/silikonové ● gumové, silikonové

gumové (EPDM, CR, NBR, NR)	mikroporézní (EPDM, CR)	silikonové		silikonové mikroporézní
		vnitřní / vnější průměr		
Ø 02,00/05,00mm	Ø 05,00/14,00mm	Ø 01,00/03,00 mm	Ø 10,00/12,00 mm	Ø 06,00/10,00mm
Ø 03,00/05,00mm	Ø 05,90/20,00mm	Ø 02,00/04,00 mm	Ø 10,00/14,00 mm	Ø 07,00/19,00mm
Ø 03,00/06,00mm	Ø 06,00/15,00mm	Ø 03,00/04,00 mm	Ø 10,00/15,00 mm	Ø 12,00/17,00mm
Ø 04,00/06,00mm	Ø 07,80/16,00mm	Ø 03,00/05,00 mm	Ø 10,00/19,00 mm	Ø 12,00/24,00mm
Ø 04,00/07,00mm	Ø 08,00/13,00mm	Ø 03,00/08,00 mm	Ø 10,00/22,00 mm	Ø 13,00/31,00mm
Ø 04,00/07,00mm	Ø 08,00/14,00mm	Ø 03,00/08,50mm	Ø 12,00/16,00 mm	Ø 20,00/34,00mm
Ø 04,00/08,00mm	Ø 08,00/16,00mm	Ø 03,00/09,00 mm	Ø 12,00/20,00 mm	Ø 20,00/40,00mm
Ø 05,00/07,00mm	Ø 08,00/18,00mm	Ø 03,50/04,30mm	Ø 13,00/17,00 mm	Ø 20,00/60,00mm
Ø 05,00/08,00mm	Ø 09,00/19,50mm	Ø 04,00/05,00 mm	Ø 13,00/18,00 mm	Ø 21,00/35,00mm
Ø 05,60/08,00mm	Ø 09,00/28,00mm	Ø 04,00/06,00 mm	Ø 13,00/19,00 mm	Ø 21,00/39,00mm
Ø 06,00/09,00mm	Ø 09,00/30,00mm	Ø 04,00/07,00 mm	Ø 14,00/18,00 mm	Ø 25,00/45,00mm
Ø 06,00/10,00mm	Ø 09,50/13,50m	Ø 04,00/07,20mm	Ø 14,00/22,00 mm	Ø 30,00/50,00mm
Ø 06,00/12,00mm	Ø 09,50/20,00mm	Ø 04,00/08,00 mm	Ø 14,00/44,00 mm	Ø 40,00/60,00mm
Ø 07,00/25,00mm	Ø 10,00/14,00mm	Ø 05,00/08,00 mm	Ø 15,00/19,00 mm	
Ø 08,00/11,00mm	Ø 10,00/15,00mm	Ø 06,00/09,00 mm	Ø 16,00/22,00 mm	
Ø 08,00/12,00mm	Ø 10,00/20,00mm	Ø 06,00/10,00 mm	Ø 17,00/20,00 mm	
Ø 08,00/15,00mm	Ø 10,00/25,00mm	Ø 06,00/12,00 mm	Ø 18,00/22,00 mm	
Ø 09,00/12,00mm	Ø 10,00/32,00mm	Ø 06,00/25,00 mm	Ø 20,00/60,00mm	
Ø 10,00/14,00mm	Ø 12,00/26,00mm	Ø 07,00/08,00 mm	Ø 24,00/28,00 mm	
Ø 10,00/32,00mm	Ø 12,00/28,00mm	Ø 07,00/10,00 mm	Ø 25,00/31,00 mm	
Ø 12,00/02,20mm	Ø 12,00/30,00mm	Ø 08,00/10,00 mm	Ø 25,00/52,00 mm	
Ø 12,00/15,00mm	Ø 14,00/20,00mm	Ø 08,00/12,00 mm	Ø 26,00/30,00 mm	
Ø 12,00/16,00mm	Ø 14,00/24,00mm	Ø 08,00/14,00 mm	Ø 30,00/44,00 mm	
Ø 12,00/17,00mm	Ø 15,00/25,00mm	Ø 09,00/13,00 mm	Ø 40,00/43,00 mm	
Ø 14,00/26,00mm	Ø 15,00/35,00mm	Ø 50,00/56,00 mm	Ø 40,00/46,00 mm	
Ø 16,00/19,00mm	Ø 15,00/36,00mm	Ø 55,00/60,00 mm	Ø 40,00/50,00 mm	
Ø 20,00/23,00mm	Ø 16,00/25,00mm	Ø 80,00/84,00 mm	Ø 44,00/54,00 mm	
Ø 20,00/24,00mm	Ø 16,00/26,00mm			
Ø 22,00/27,00mm	Ø 16,00/30,00mm			
Ø 24,00/28,00mm	Ø 16,00/36,00mm			
Ø 28,00/32,00mm	Ø 18,00/25,00mm			
Ø 28,00/40,00mm	Ø 18,00/26,00mm			
	Ø 18,00/35,00mm			
	Ø 19,00/25,00mm			
	Ø 19,00/30,00mm			
	Ø 20,00/50,00mm			
	Ø 22,00/30,00mm			
	Ø 22,00/48,00mm			
	Ø 23,00/34,00mm			
	Ø 28,00/46,00mm			

Uvedené rozměry lze dodat ve všech uvedených materiálech..

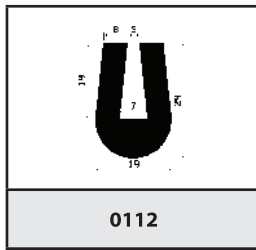

0112

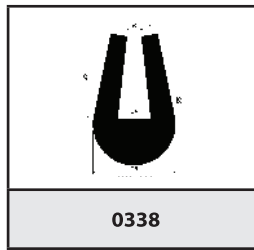

0338

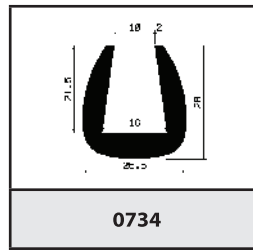

0734

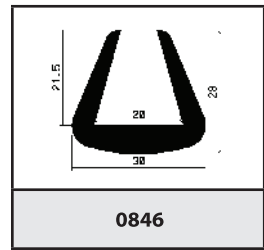

0846

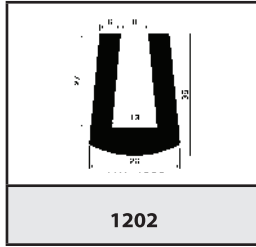

1202

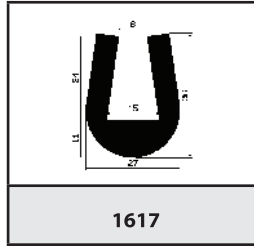

1617

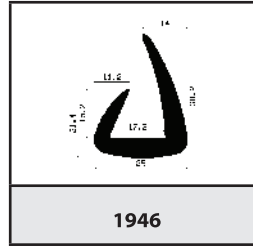

1946

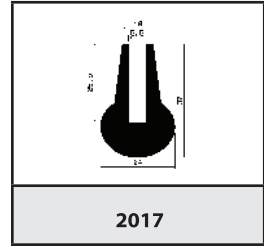

2017

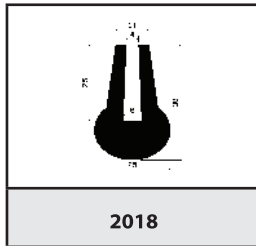

2018

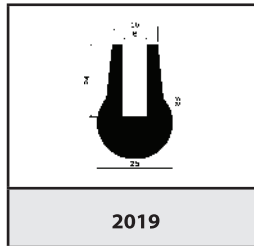

2019

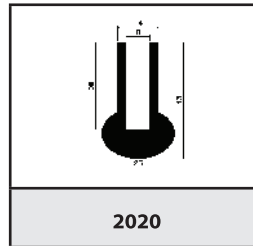

2020

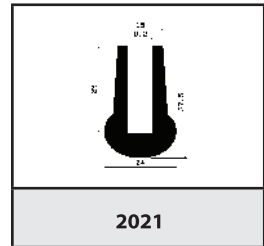

2021

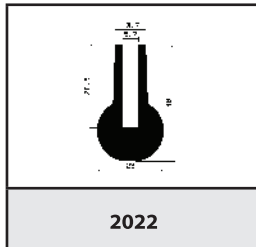

2022

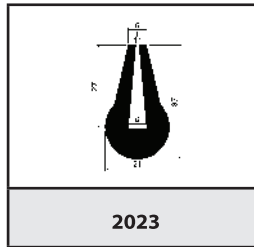

2023

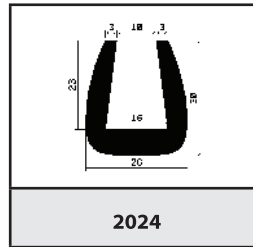

2024

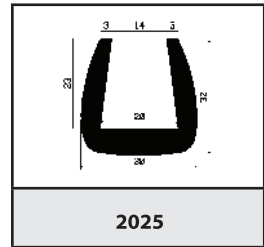

2025

○ mikroporézní, mikroporézní/silikonové ● gumové, silikonové

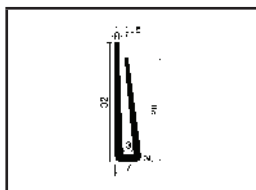

0040

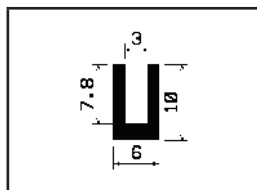

0070

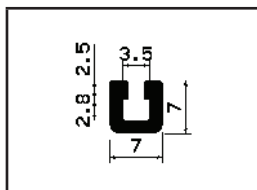

0111

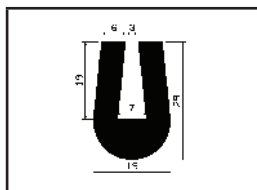

0112

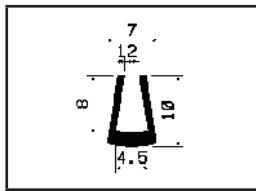

0113

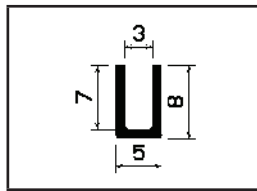

0116

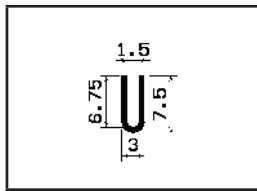

0121

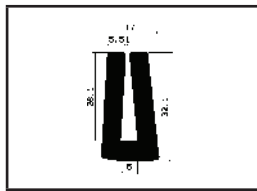

0154

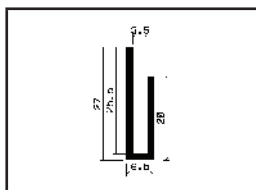

0181

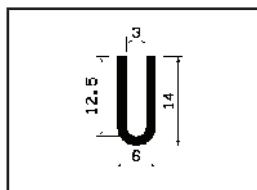

0186

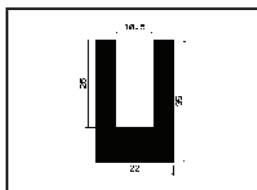

0223

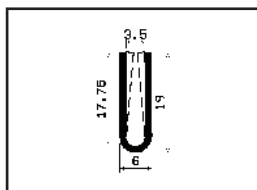

0228

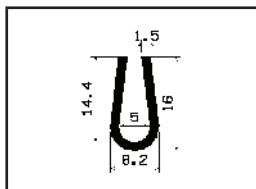

0229

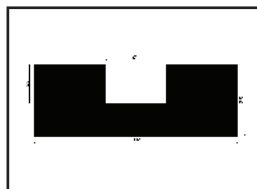

0246

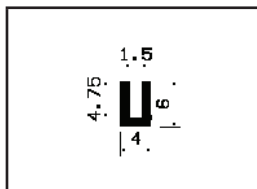

0290

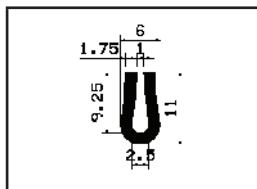

0292

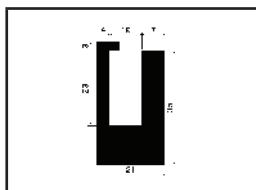

0299

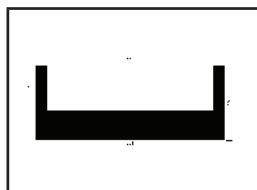

0304

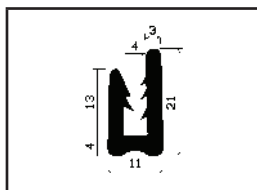

0305

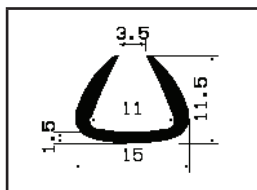

0306

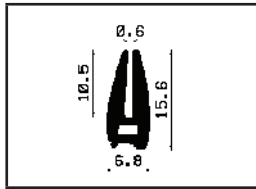

0317

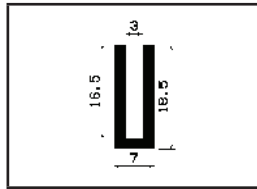

0320

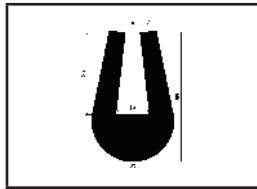

0338

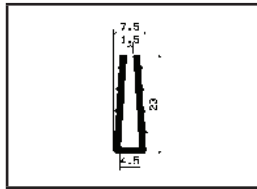

0350

○ mikroporézni, mikroporézni/silikonové ● gumové, silikonové

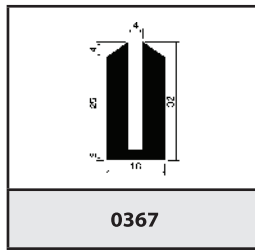

0367

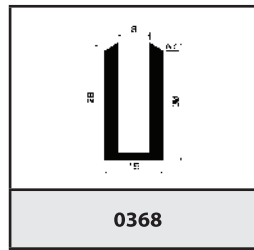

0368

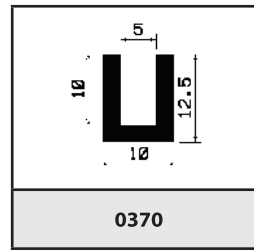

0370

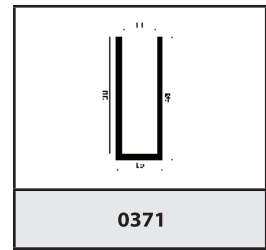

0371

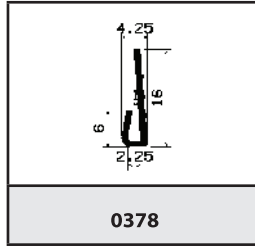

0378

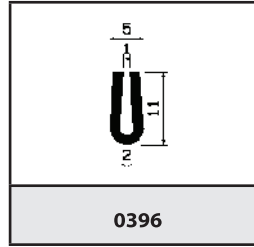

0396

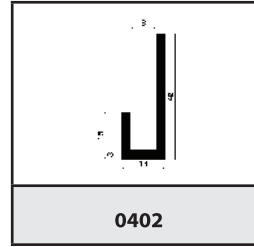

0402

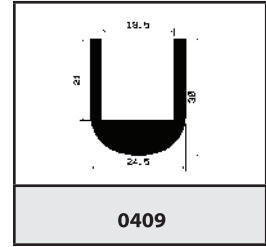

0409

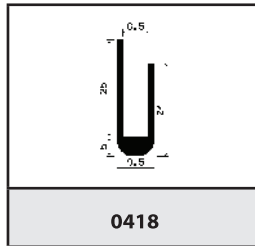

0418

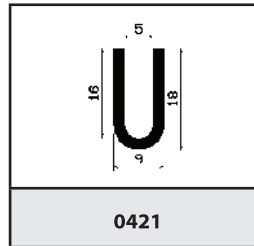

0421

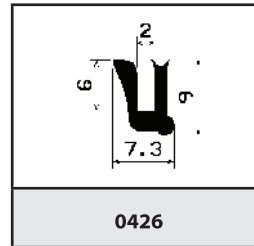

0426

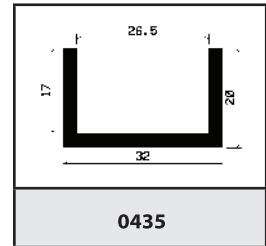

0435

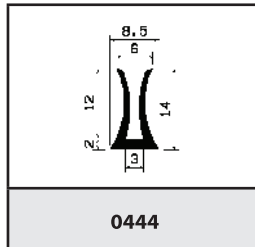

0444

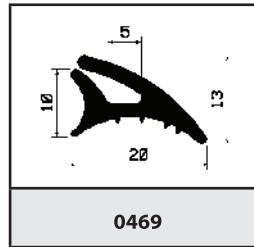

0469

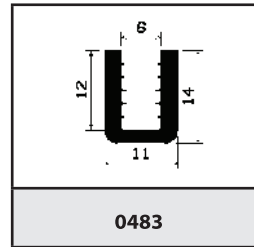

0483

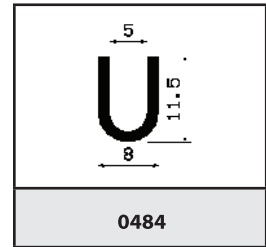

0484

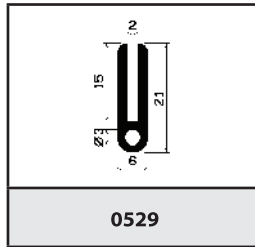

0529

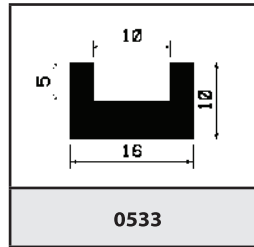

0533

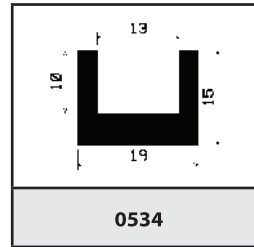

0534

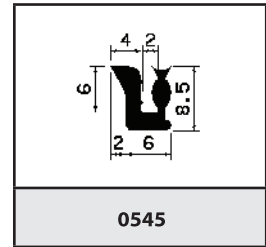

0545

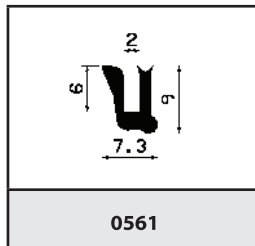

0561

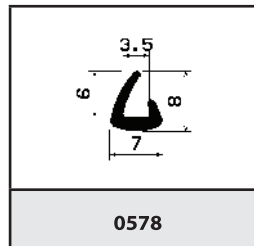

0578

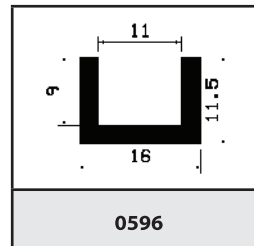

0596

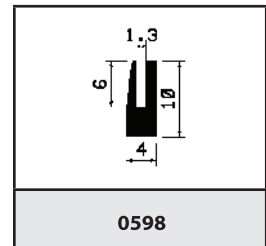

0598

○ mikroporézní, mikroporézní/silikonové ● gumové, silikonové

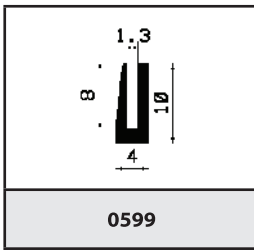

0599

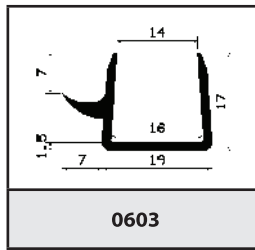

0603

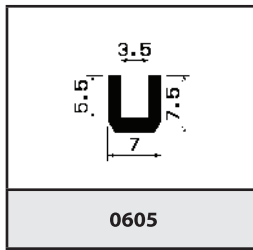

0605

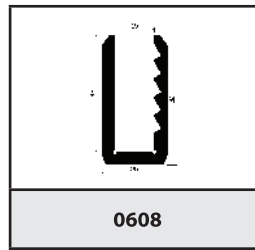

0608

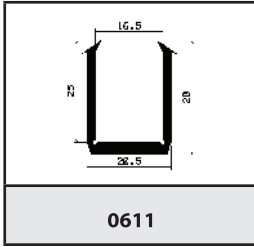

0611

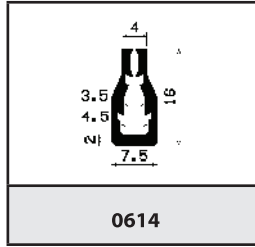

0614

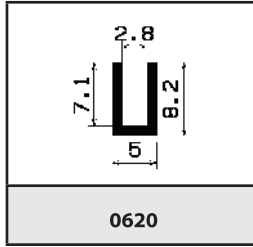

0620

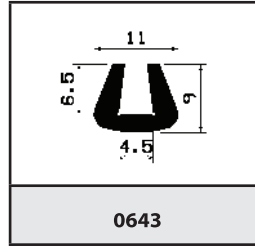

0643

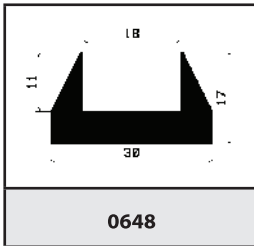

0648

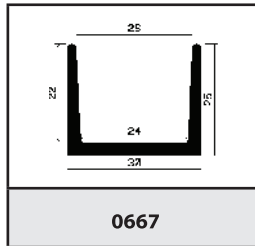

0667

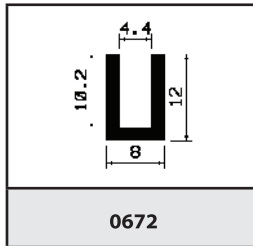

0672

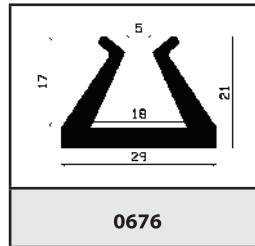

0676

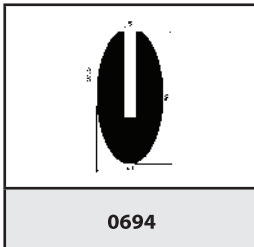

0694

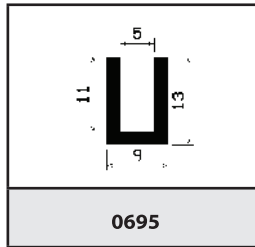

0695

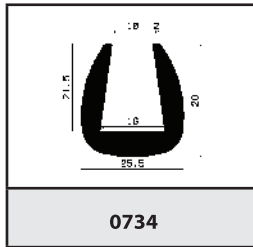

0734

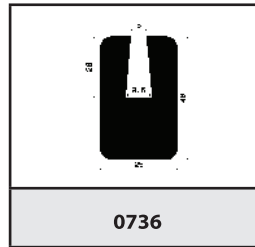

0736

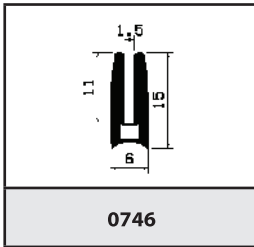

0746

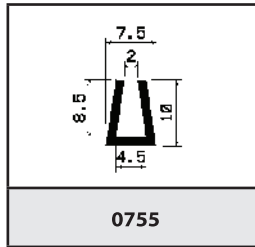

0755

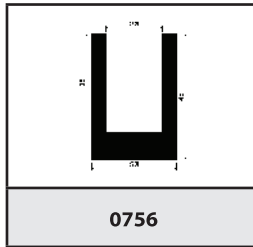

0756

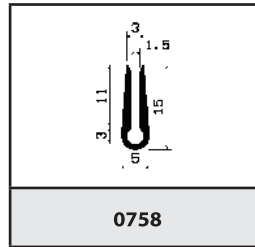

0758

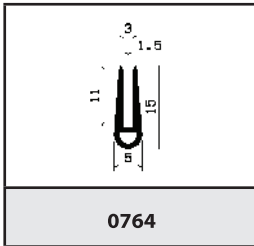

0764

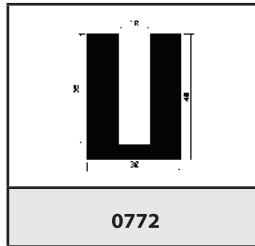

0772

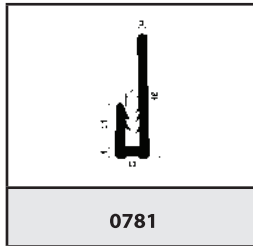

0781

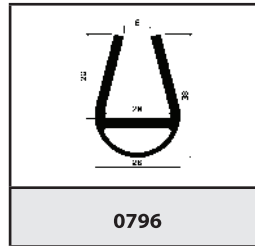

0796

○ mikroporézni, mikroporézni/silikonové ● gumové, silikonové

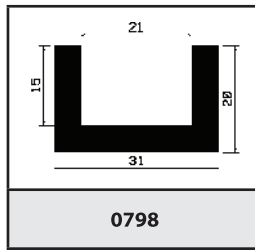

0798

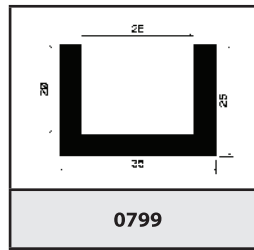

0799

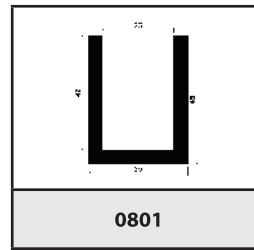

0801

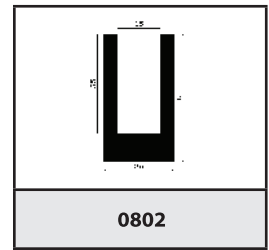

0802

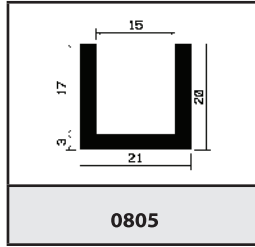

0805

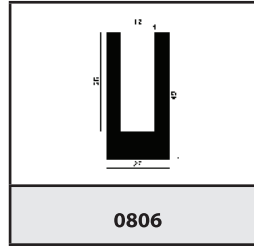

0806

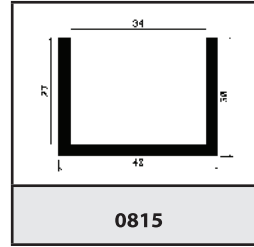

0815

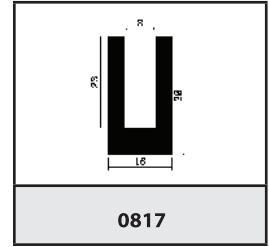

0817

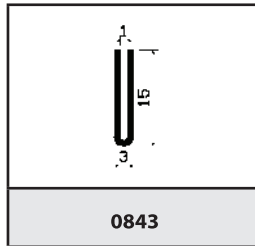

0843

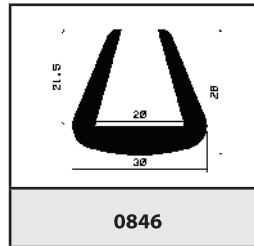

0846

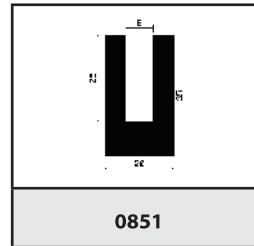

0851

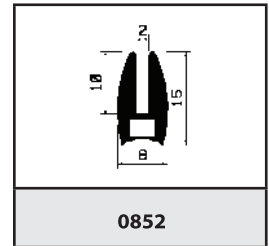

0852

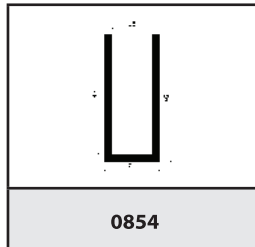

0854

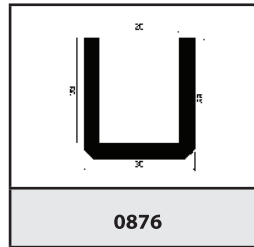

0876

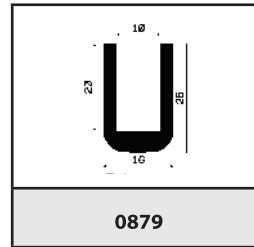

0879

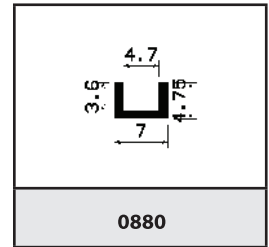

0880

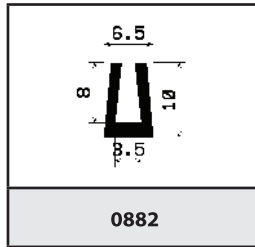

0882

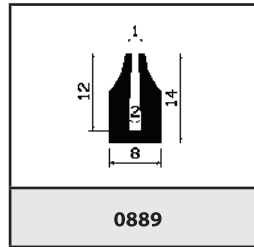

0889

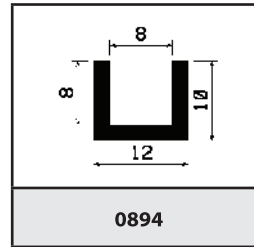

0894

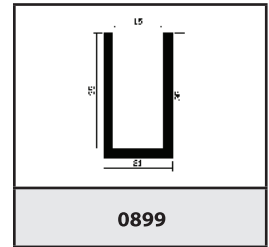

0899

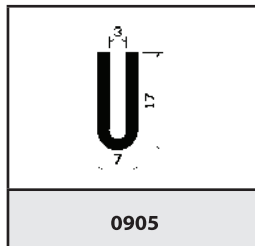

0905

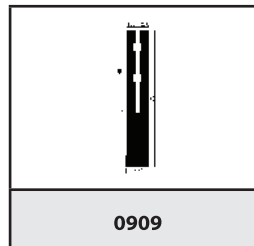

0909

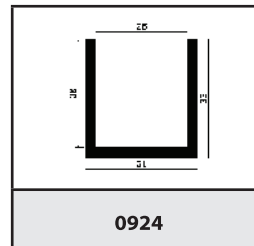

0924

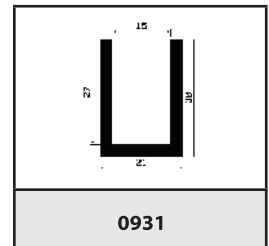

0931

○ mikroporézní, mikroporézní/silikonové ● gumové, silikonové

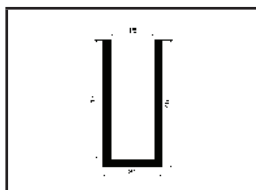

0932

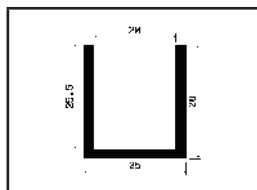

0944

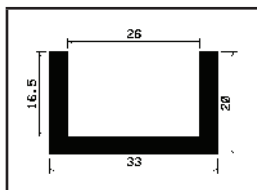

0946

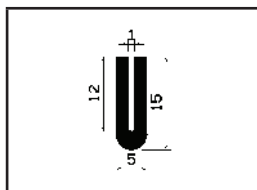

0947

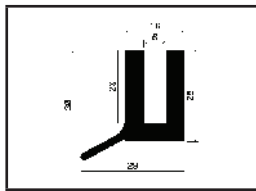

0948

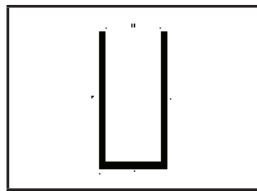

0957

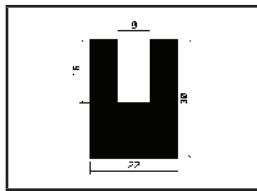

0968

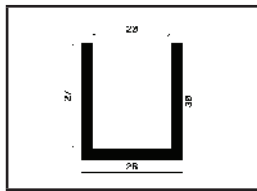

0971

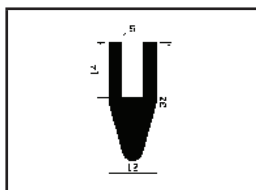

0987

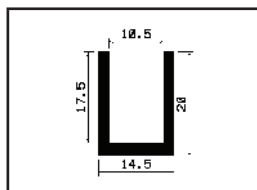

1000

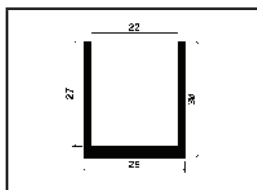

1006

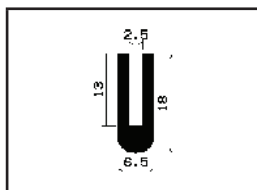

1011

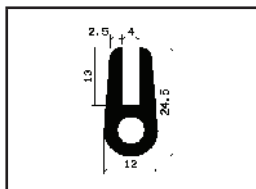

1022

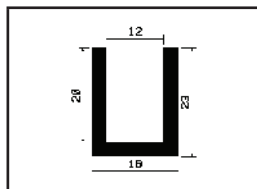

1023

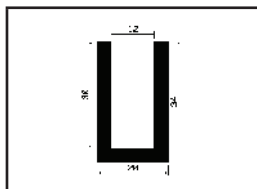

1024

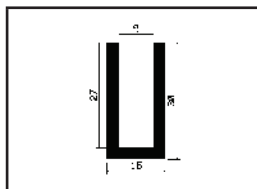

1028

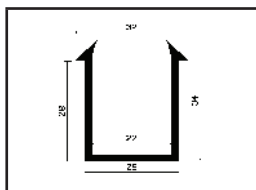

1030

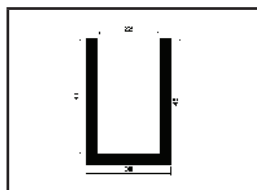

1033

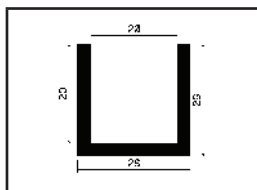

1034

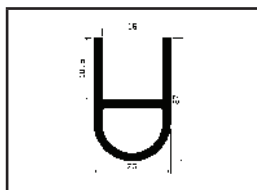

1035

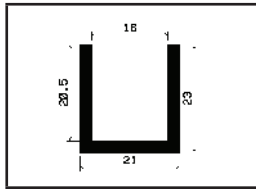

1036

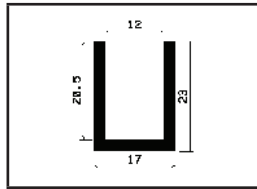

1042

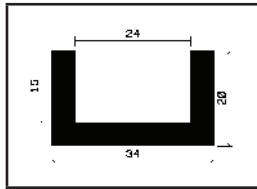

1043

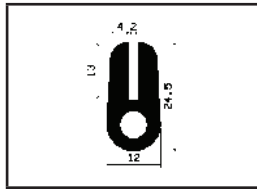

1044

○ mikroporézni, mikroporézni/silikonové ● gumové, silikonové

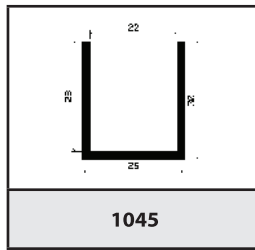

1045

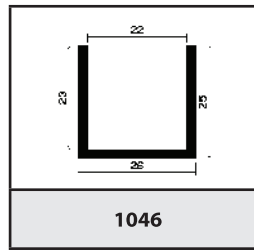

1046

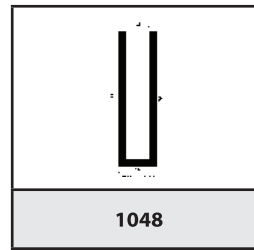

1048

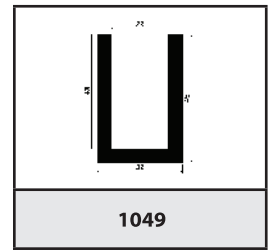

1049

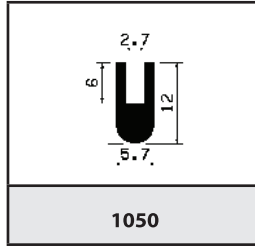

1050

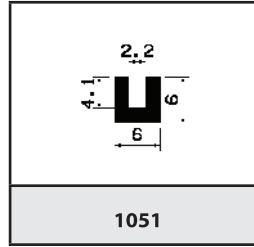

1051

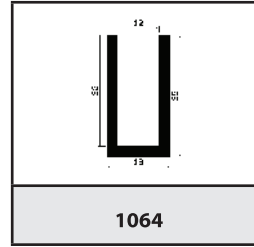

1064

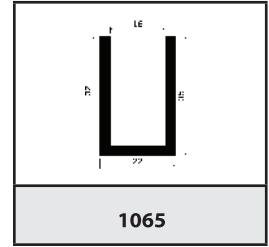

1065

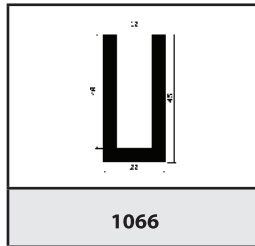

1066

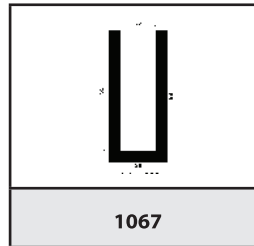

1067

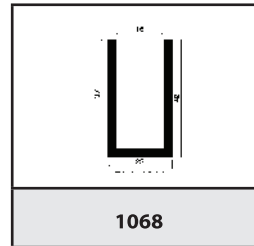

1068

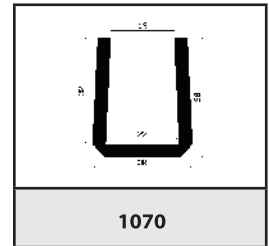

1070

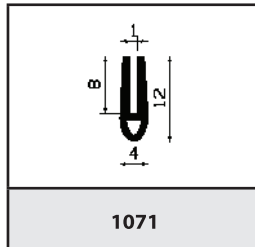

1071

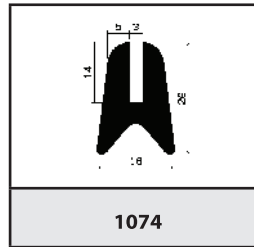

1074

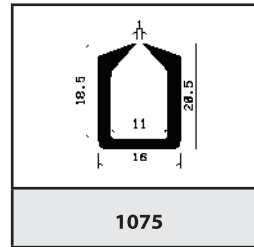

1075

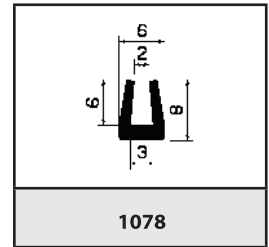

1078

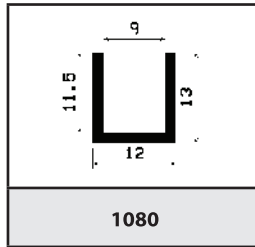

1080

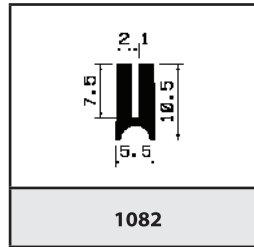

1082

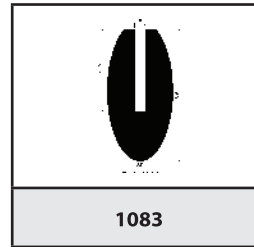

1083

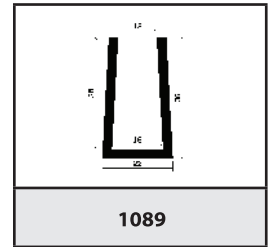

1089

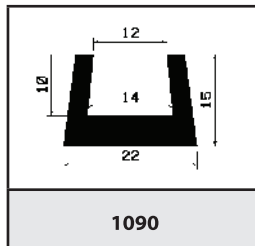

1090

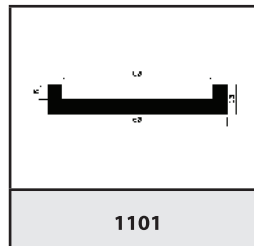

1101

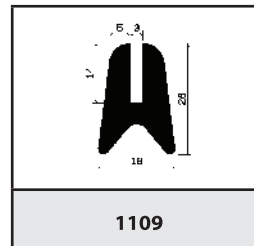

1109

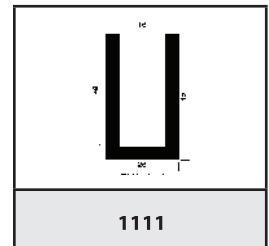

1111

○ mikroporézní, mikroporézní/silikonové ● gumové, silikonové

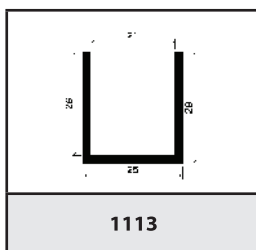

1113

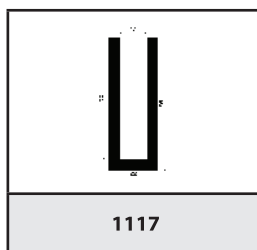

1117

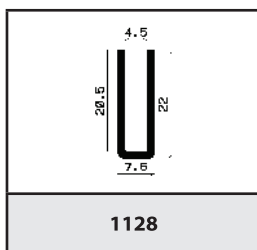

1128

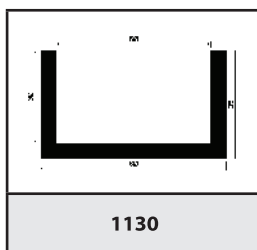

1130

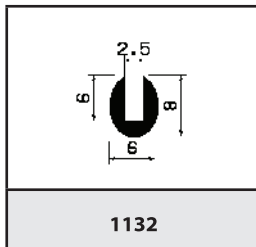

1132

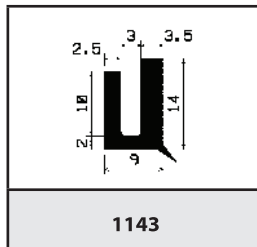

1143

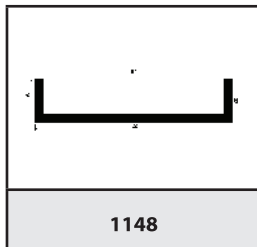

1148

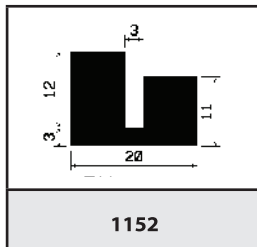

1152

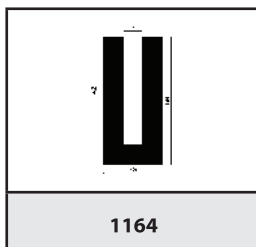

1164

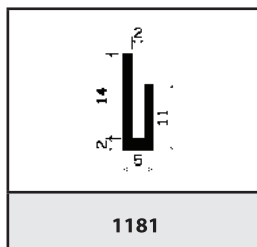

1181

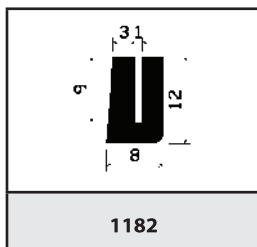

1182

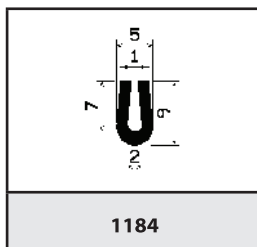

1184

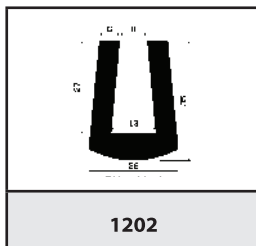

1202

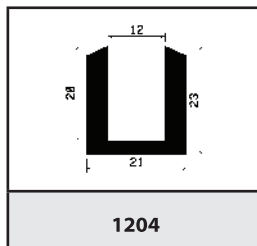

1204

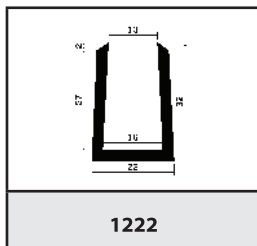

1222

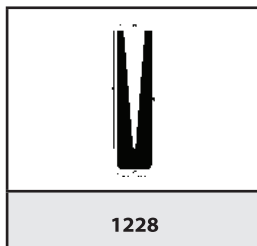

1228

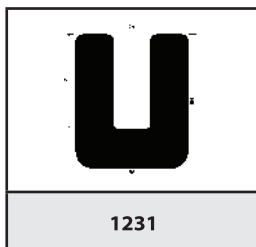

1231

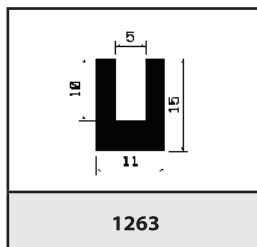

1263

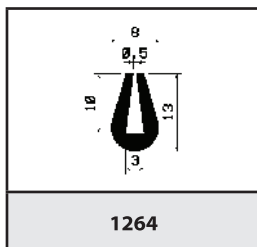

1264

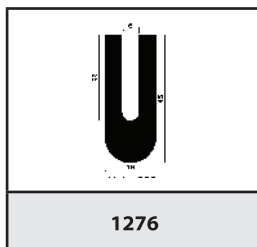

1276

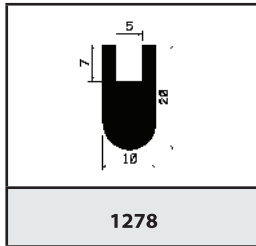

1278

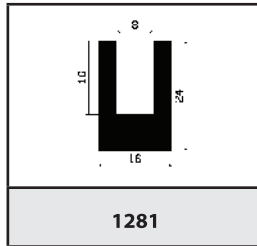

1281

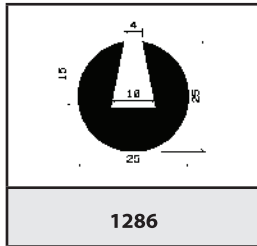

1286

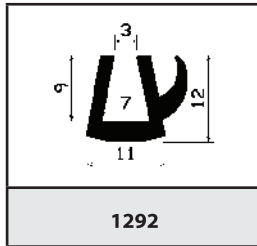

1292

○ mikroporézní, mikroporézní/silikonové ● gumové, silikonové

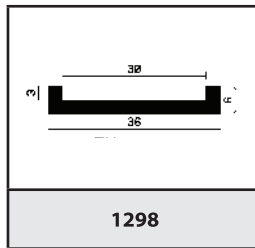

1298

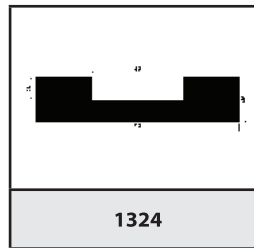

1324

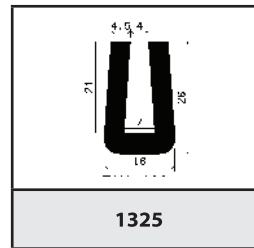

1325

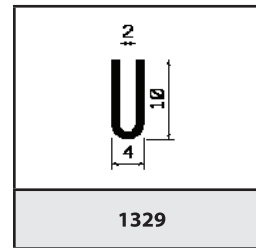

1329

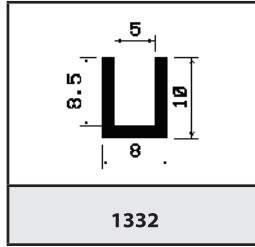

1332

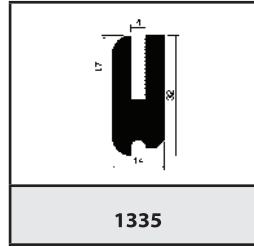

1335

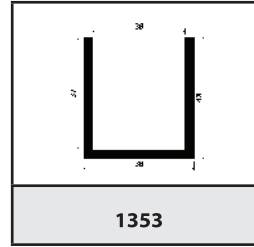

1353

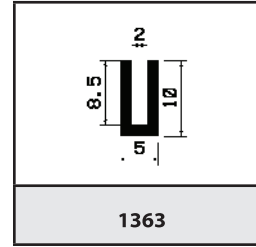

1363

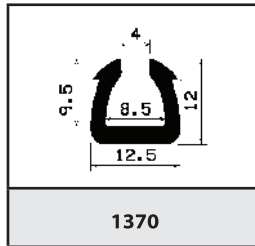

1370

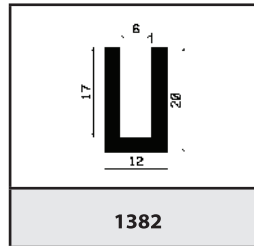

1382

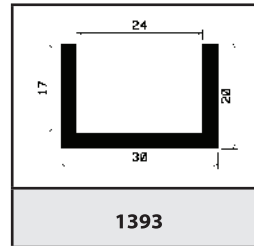

1393

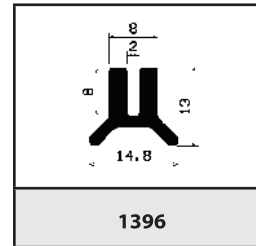

1396

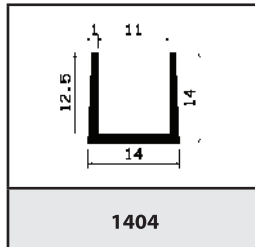

1404

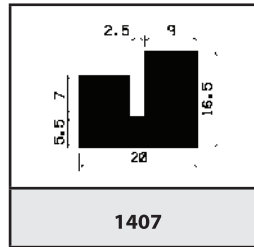

1407

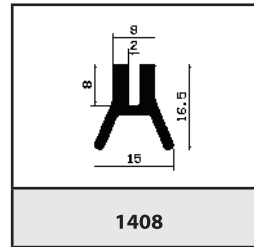

1408

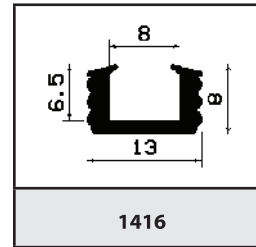

1416

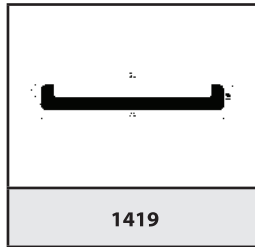

1419

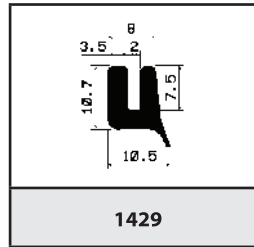

1429

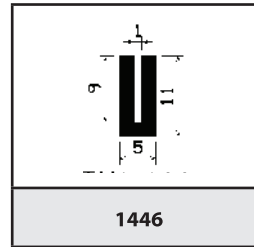

1446

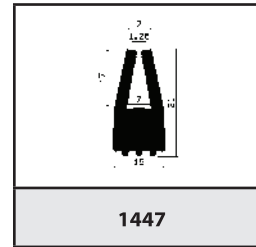

1447

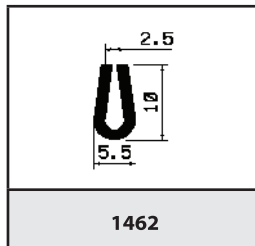

1462

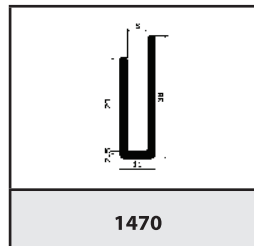

1470

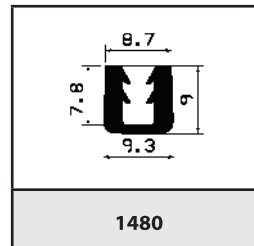

1480

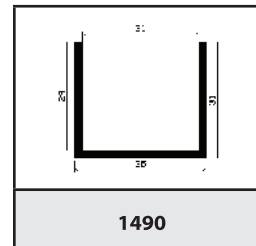

1490

○ mikroporézní, mikroporézní/silikonové ● gumové, silikonové

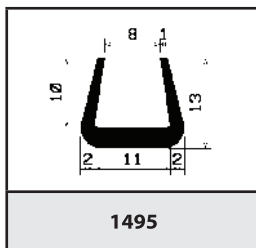

1495

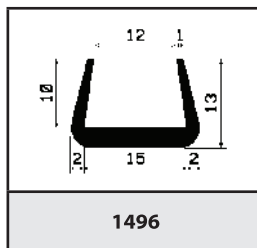

1496

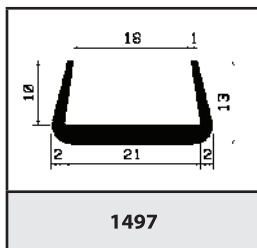

1497

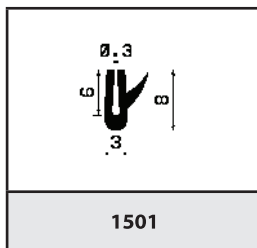

1501

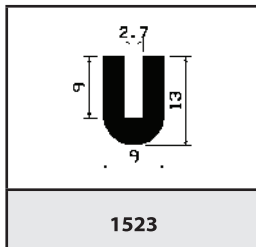

1523

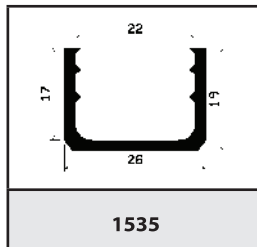

1535

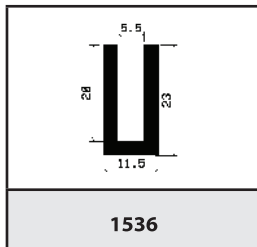

1536

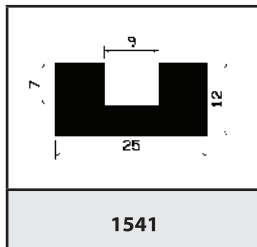

1541

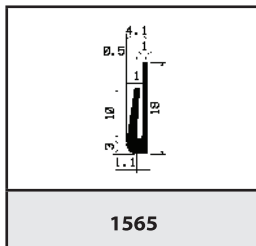

1565

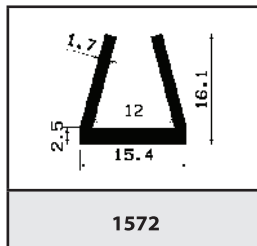

1572

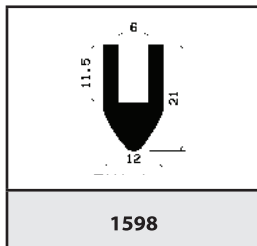

1598

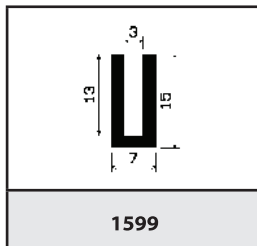

1599

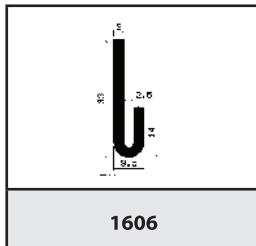

1606

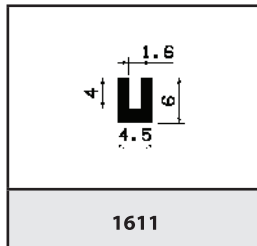

1611

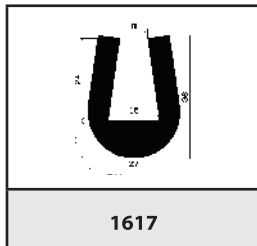

1617

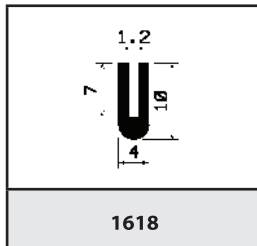

1618

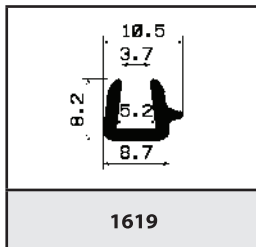

1619

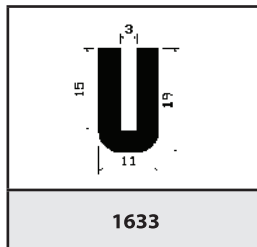

1633

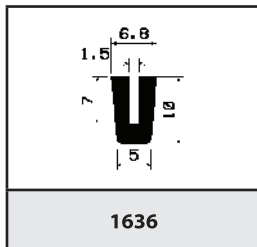

1636

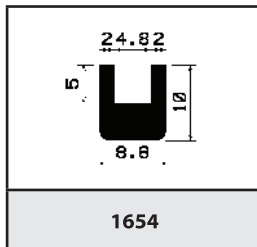

1654

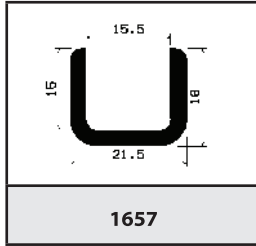

1657

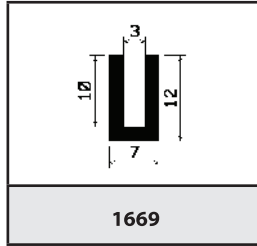

1669

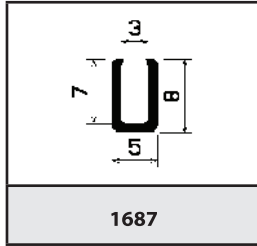

1687

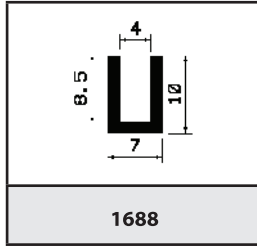

1688

○ mikroporézni, mikroporézni/silikonové ● gumové, silikonové

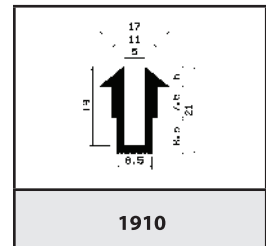
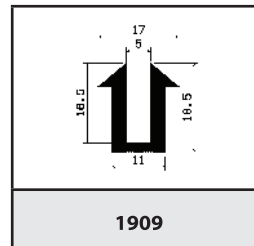
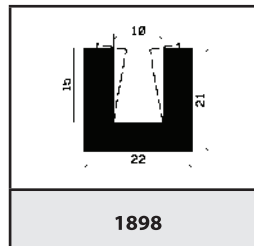
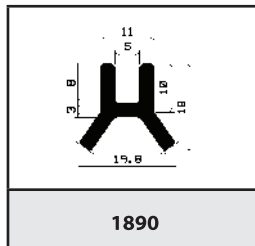
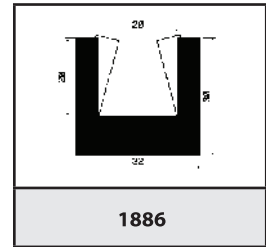
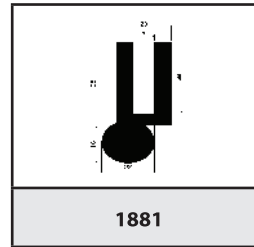
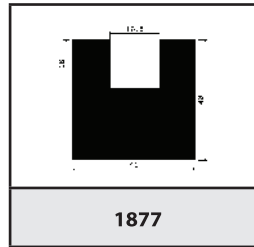
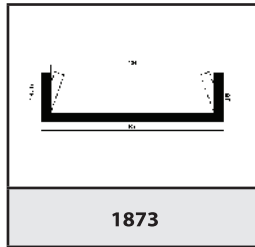
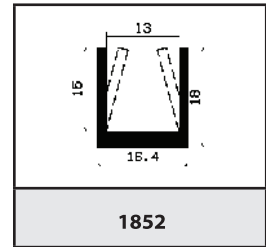
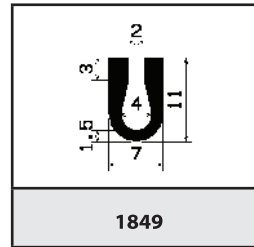
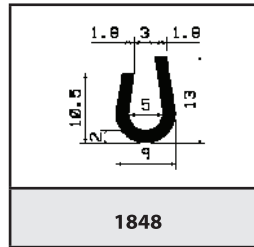
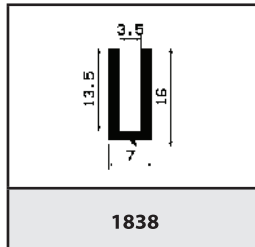
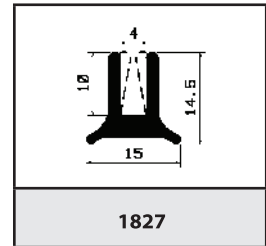
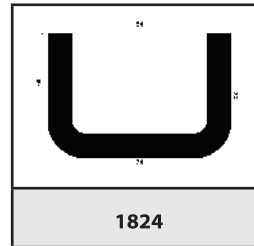
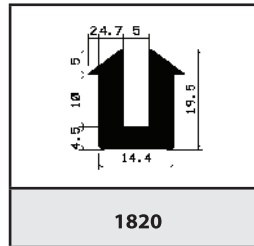
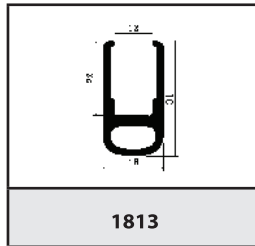
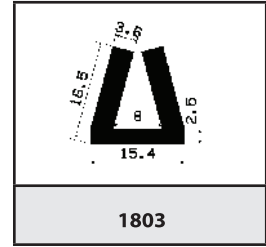
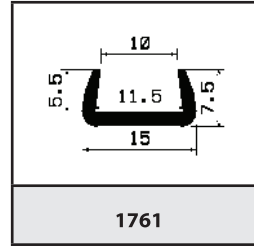
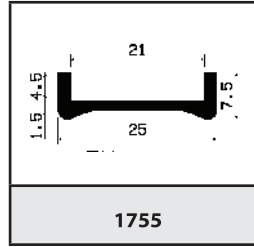
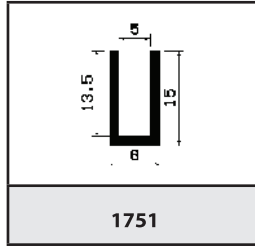
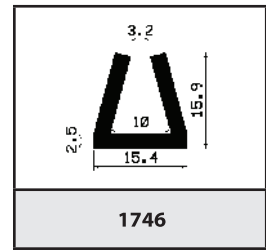
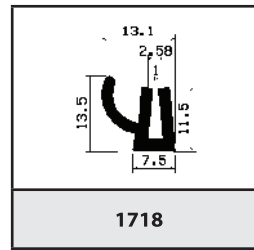
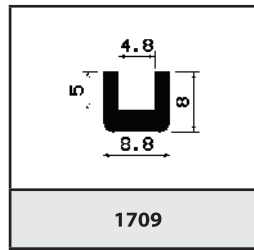
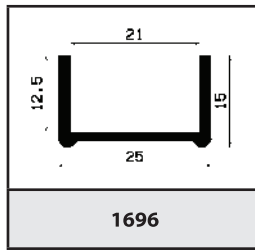

○ mikroporézní, mikroporézní/silikonové ● gumové, silikonové

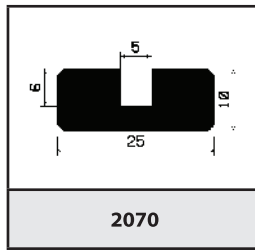

2070

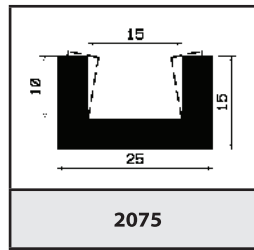

2075

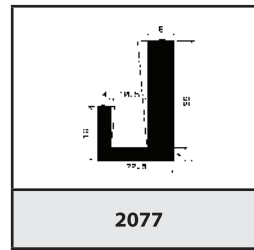

2077

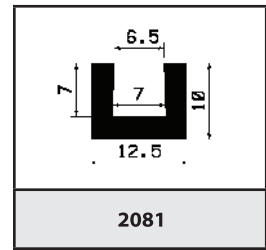

2081

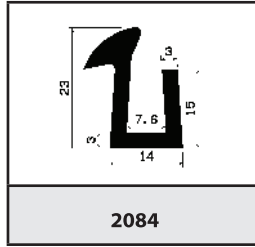

2084

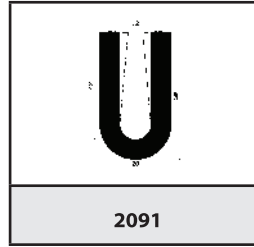

2091

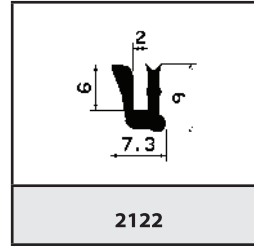

2122

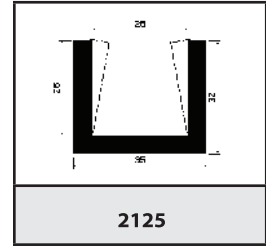

2125

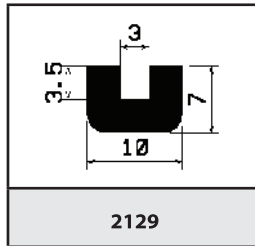

2129

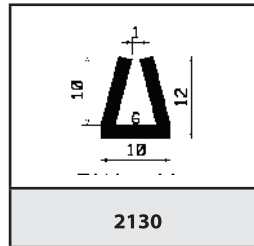

2130

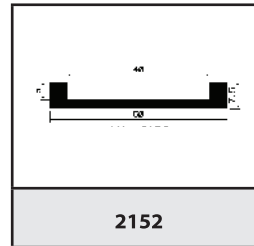

2152

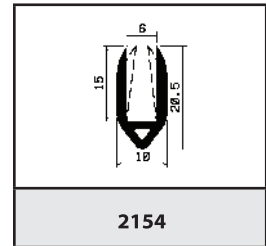

2154

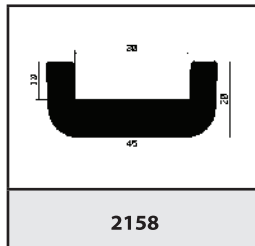

2158

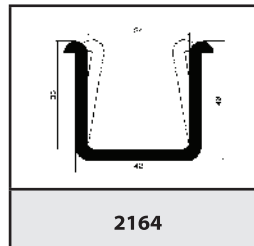

2164

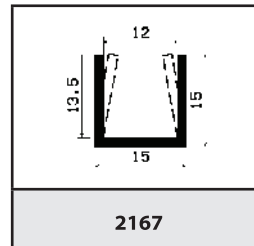

2167

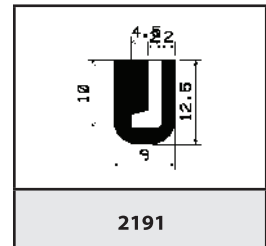

2191

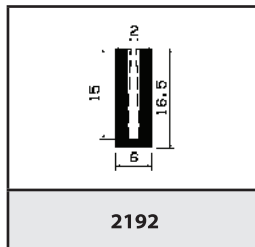

2192

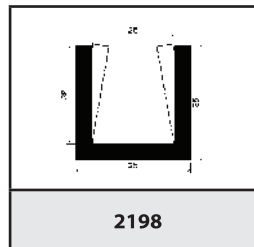

2198

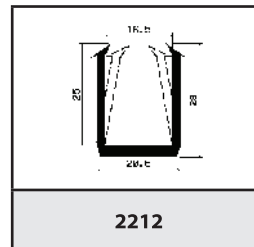

2212

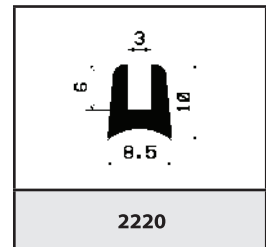

2220

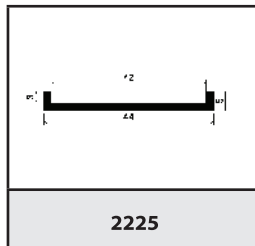

2225

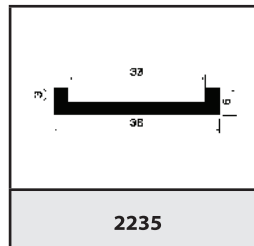

2235

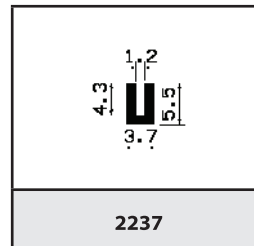

2237

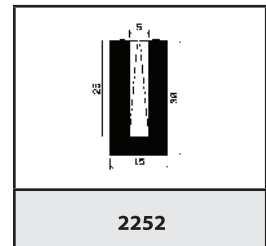

2252

○ mikroporézni, mikroporézni/silikonové ● gumové, silikonové

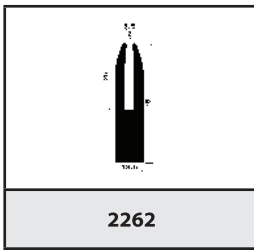

2262

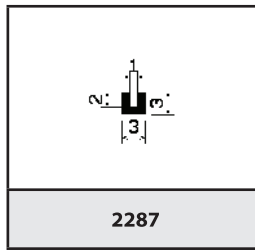

2287

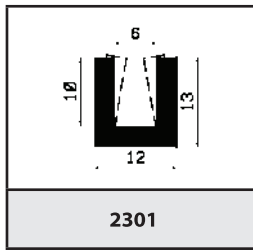

2301

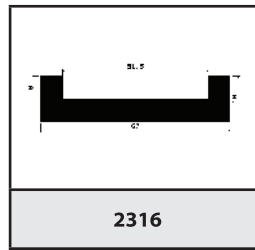

2316

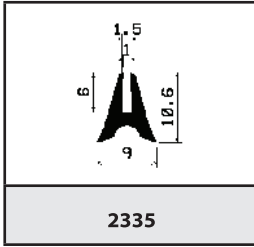

2335

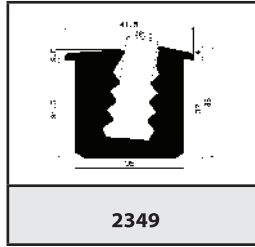

2349

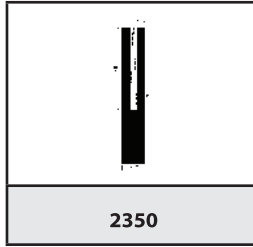

2350

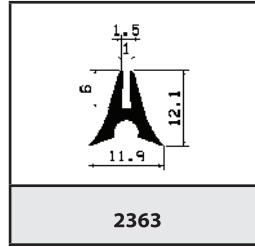

2363

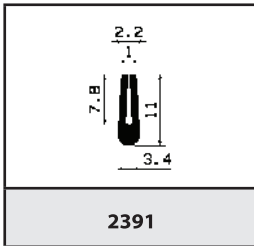

2391

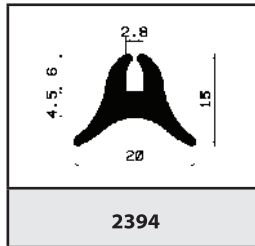

2394

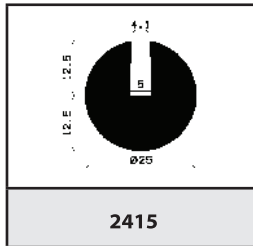

2415

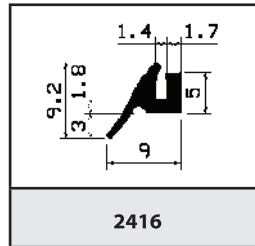

2416

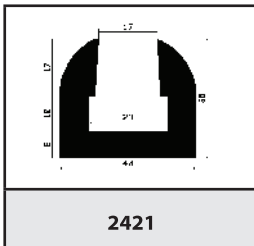

2421

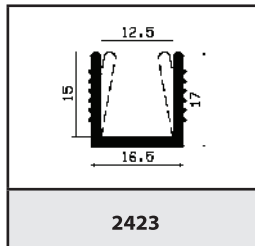

2423

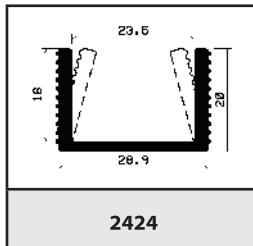

2424

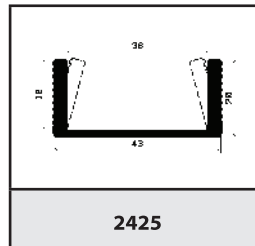

2425

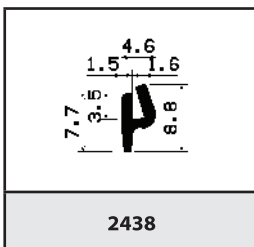

2438

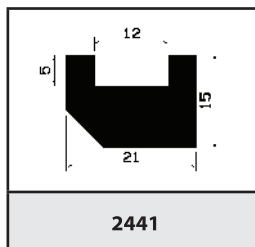

2441

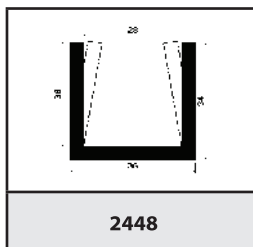

2448

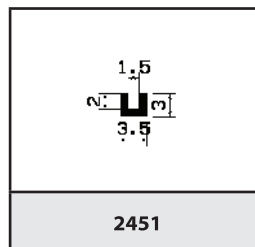

2451

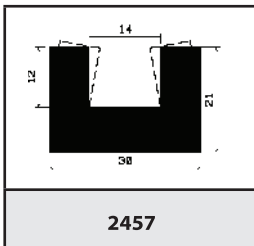

2457

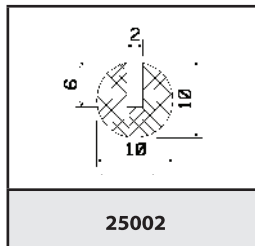

25002

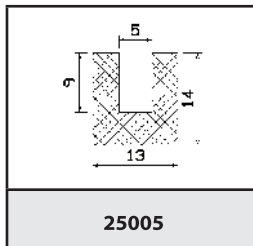

25005

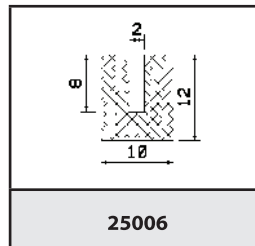

25006

○ mikroporézni, mikroporézni/silikonové ● gumové, silikonové

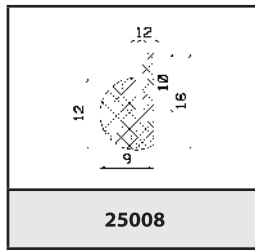

25008

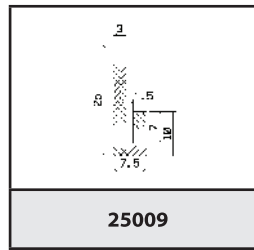

25009

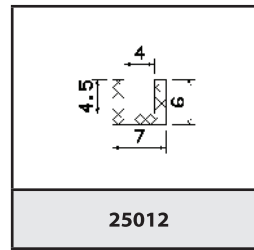

25012

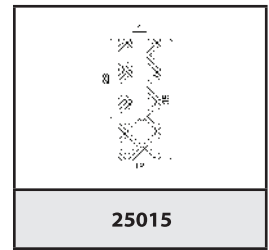

25015

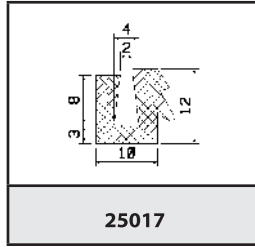

25017

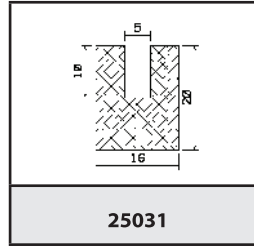

25031

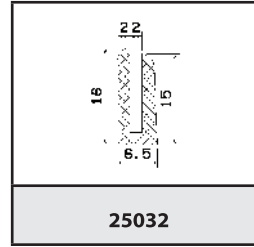

25032

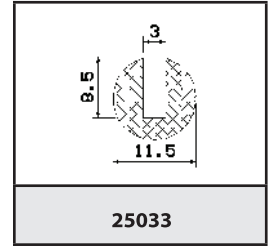

25033

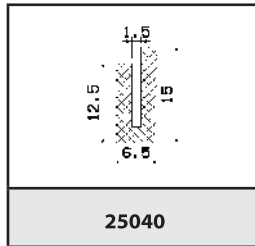

25040

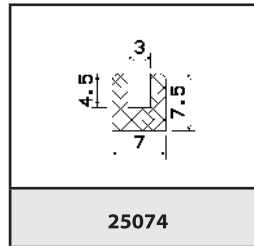

25074

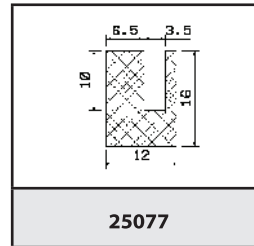

25077

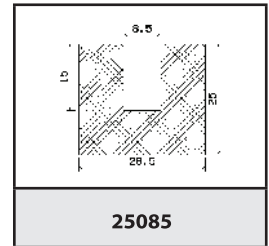

25085

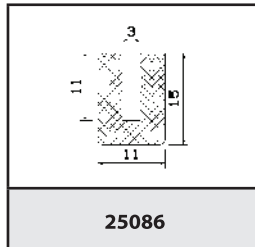

25086

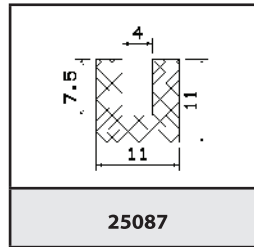

25087

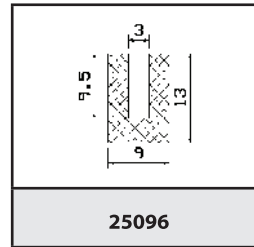

25096

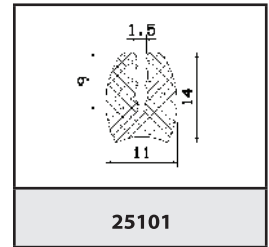

25101

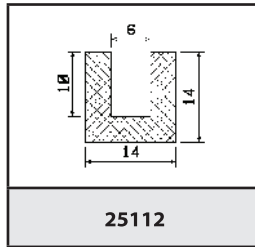

25112

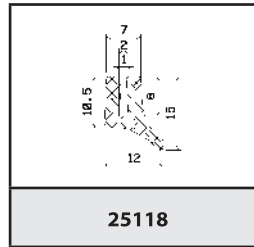

25118

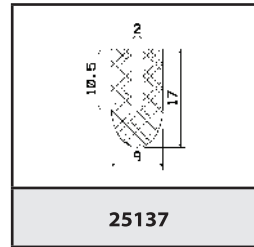

25137

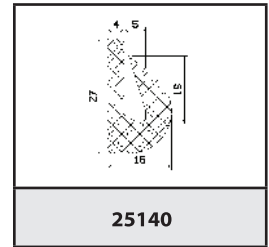

25140

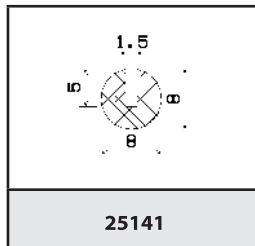

25141

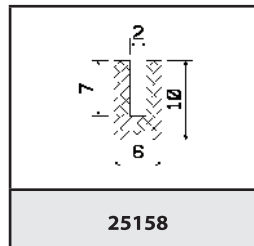

25158

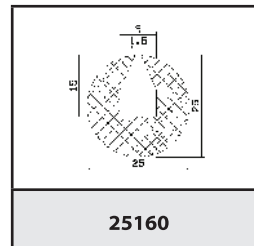

25160

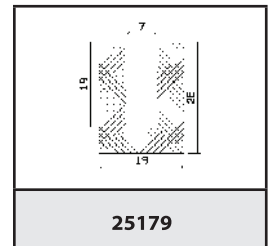

25179

○ mikroporézní, mikroporézní/silikonové ● gumové, silikonové

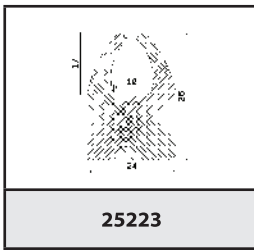

25223

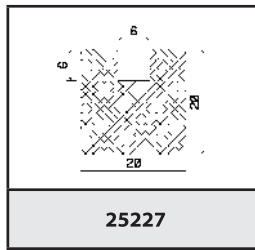

25227

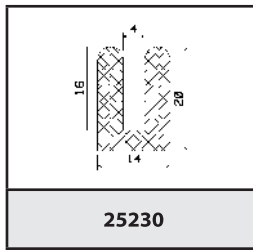

25230

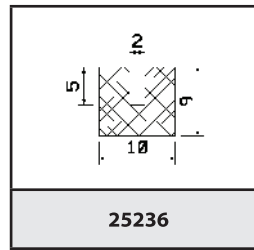

25236

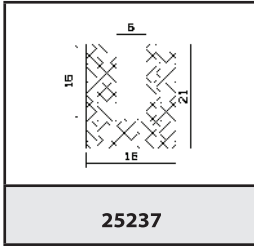

25237

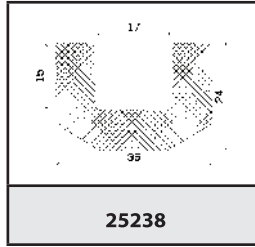

25238

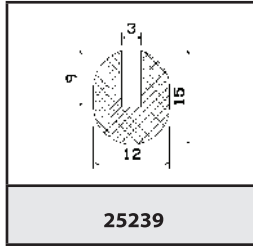

25239

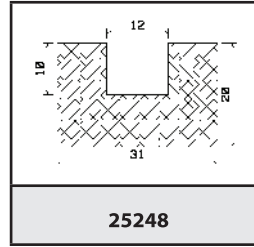

25248

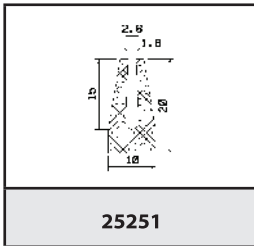

25251

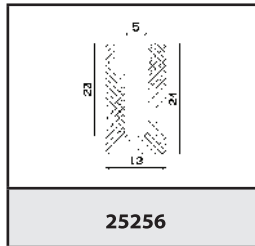

25256

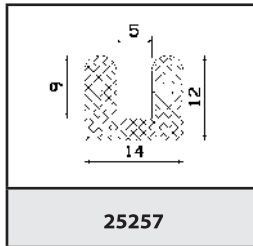

25257

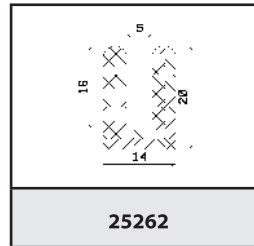

25262

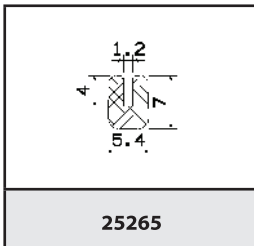

25265

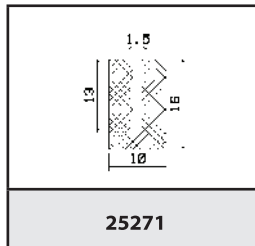

25271

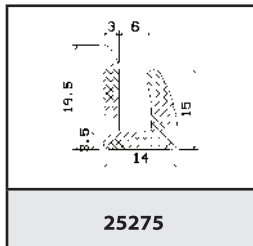

25275

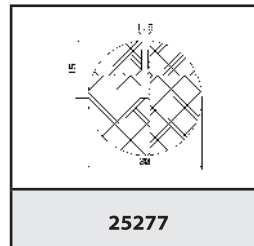

25277

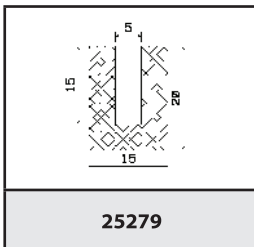

25279

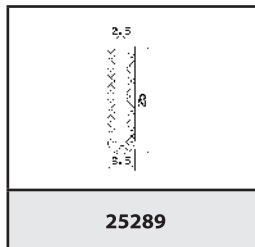

25289

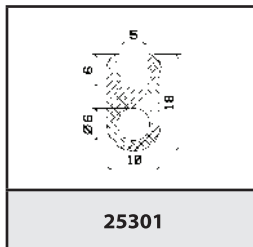

25301

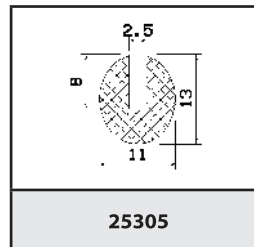

25305

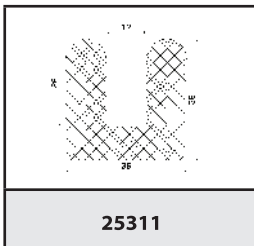

25311

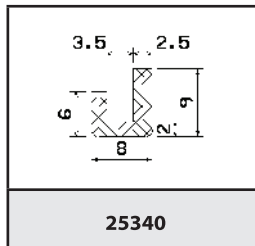

25340

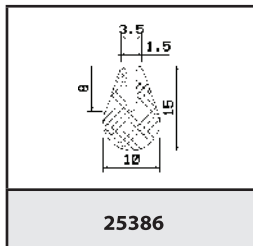

25386

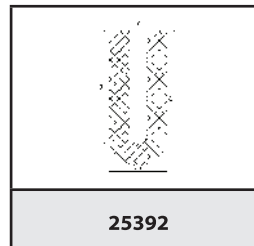

25392

○ mikroporézni, mikroporézni/silikonové ● gumové, silikonové

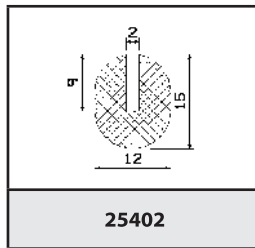

25402

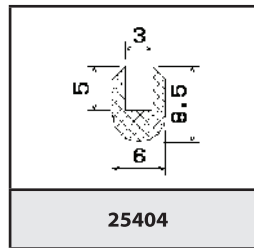

25404

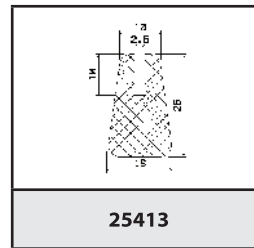

25413

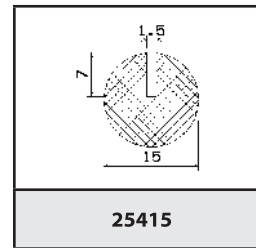

25415

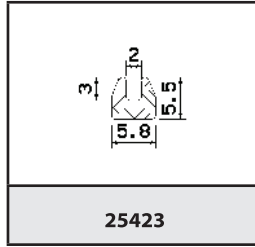

25423

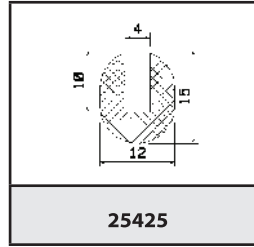

25425

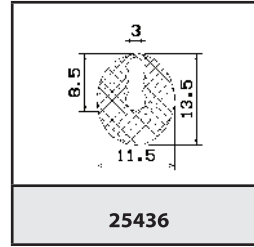

25436

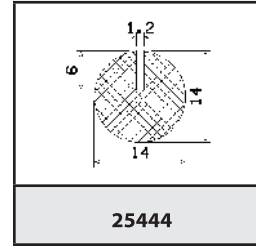

25444

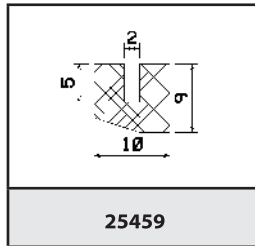

25459

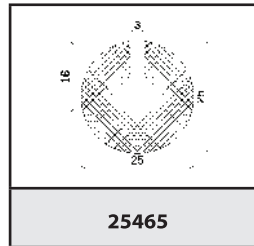

25465

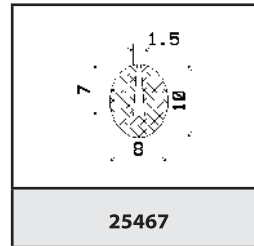

25467

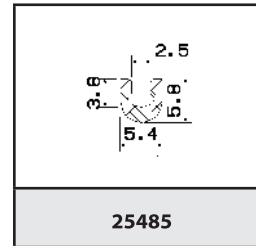

25485

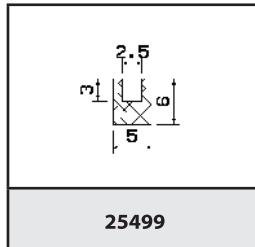

25499

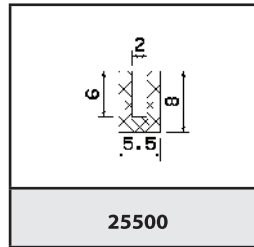

25500

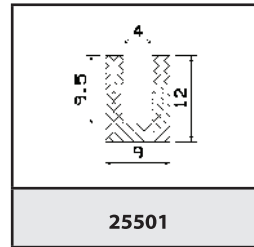

25501

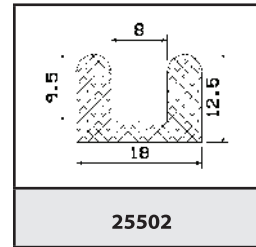

25502

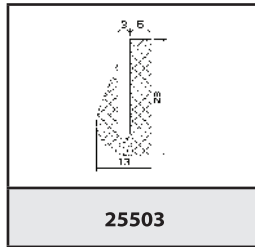

25503

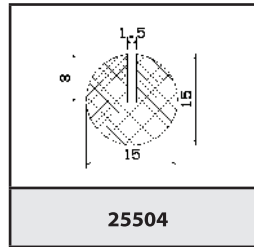

25504

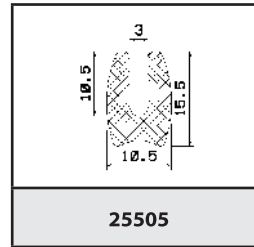

25505

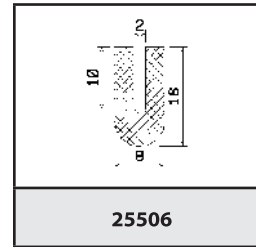

25506

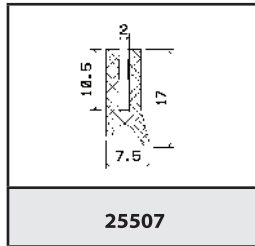

25507

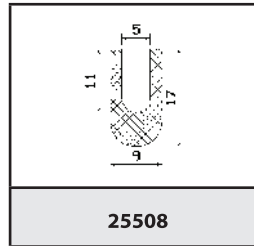

25508

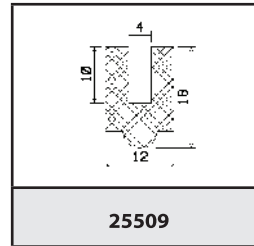

25509

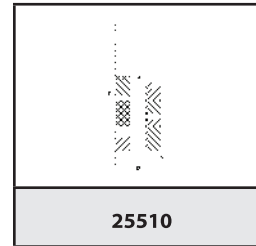

25510

○ mikroporézní, mikroporézní/silikonové ● gumové, silikonové

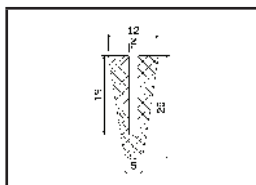

25661

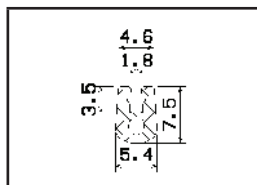

25662

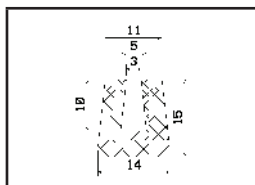

25667

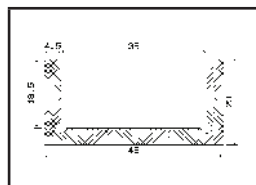

25670

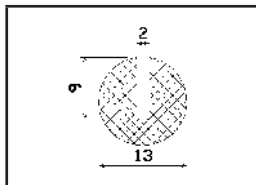

25697

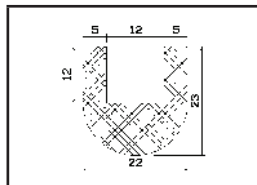

25699

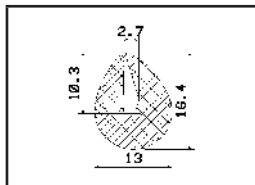

25701

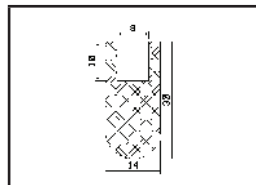

25725

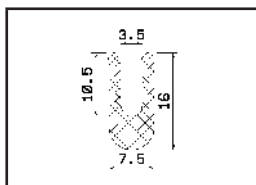

25730

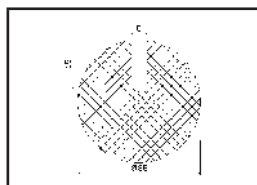

25742

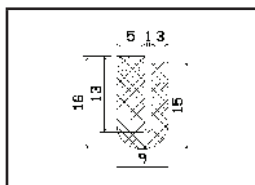

25750

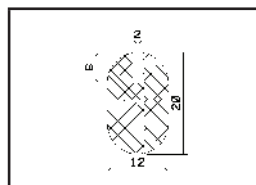

25757

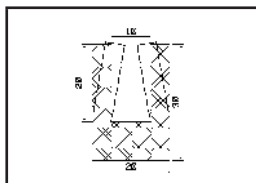

25764

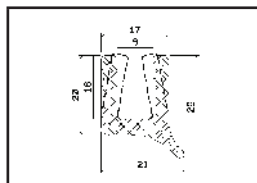

25773

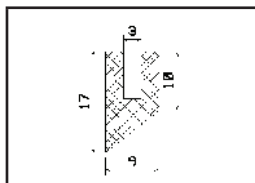

25787

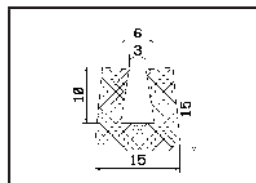

25799

○ mikroporézni, mikroporézni/silikonové ● gumové, silikonové

MIKROPORÉZNÍ

(výška x šířka)

02x06mm	04x20mm	06x11mm	09x16mm
02x06mm	04x25mm	06x12mm	09x23mm
02x08mm	04x25mm	06x12mm	09x23mm
02x08mm	04x30mm	06x13mm	10x100mm
02x09mm	04x30mm	06x15mm	10x10mm
02x09mm	04x35mm	06x15mm	10x10mm
02x10mm	04x35mm	06x16mm	10x10mm
02x10mm	04x40mm	06x16mm	10x10mm
02x15mm	04x40mm	06x20mm	10x11mm
02x15mm	04x45mm	06x20mm	10x11mm
02x20mm	04x45mm	06x22mm	10x12mm
02x20mm	04x50mm	06x25mm	10x12mm
02x25mm	04x50mm	06x25mm	10x15mm
02x25mm	04,5x05mm	06x30mm	10x15mm
02x50mm	04,5x06,5mm	06x30mm	10x16mm
02x50mm	05x05mm	06x35mm	10x16mm
03x03mm	05x05mm	06x35mm	10x17mm
03x03,5mm	05x06mm	06x40mm	10x17mm
03x05mm	05x06mm	06x40mm	10x18mm
03x05mm	05x08mm	06x42mm	10x18mm
03x06mm	05x08mm	06x50mm	10x20mm
03x10mm	05x10mm	06x50mm	10x20mm
03x10mm	05x10mm	06x70mm	10x20mm
03x110mm	05x10mm	06,5x08,5mm	10x20mm
03x110mm	05x12mm	07x07mm	10x23mm
03x113mm	05x12mm	07x10mm	10x23mm
03x113mm	05x14mm	07x10mm	10x25mm
03x12mm	05x15mm	07x15mm	10x25mm
03x12mm	05x15mm	07x15mm	10x30mm
03x141mm	05x15mm	07x20mm	10x30mm
03x15mm	05x18mm	07x20mm	10x30mm
03x15mm	05x20mm	07x50mm	10x30mm
03x18mm	05x20mm	07x60mm	10x35mm
03x18mm	05x20mm	07x70mm	10x35mm
03x20mm	05x25mm	08x08mm	10x40mm
03x20mm	05x25mm	08x08mm	10x40mm
03x22mm	05x25mm	08x10mm	10x40mm
03x25mm	05x28mm	08x10mm	10x40mm
03x25mm	05x30mm	08x12mm	10x45mm
03x30mm	05x30mm	08x12mm	10x45mm
03x30mm	05x35mm	08x15mm	10x50mm
03x35mm	05x35mm	08x15mm	10x50mm
03x35mm	05x40mm	08x16mm	10x50mm
03x40mm	05x40mm	08x16mm	10x50mm
03x40mm	05x40mm	08x18mm	10x50mm
03x50mm	05x42mm	08x18mm	10x60mm
03x50mm	05x45mm	08x20mm	10x60mm
03x95mm	05x45mm	08x20mm	10x70mm
04x04mm	05x50mm	08x20mm	10x70mm
04x05mm	05x50mm	08x25mm	10x70mm
04x05mm	05x50mm	08x25mm	11x14mm
04x05,7mm	05x50mm	08x30mm	11x15mm
04x06mm	05x60mm	08x30mm	11x17mm
04x06mm	05x60mm	08x35mm	11x18mm
04x07mm	05x65mm	08x35mm	11x26mm
04x08mm	05x70mm	08x40mm	12x12mm
04x08mm	05x70mm	08x40mm	12x12mm
04x10mm	06x06mm	08x45mm	12x15mm
04x10mm	06x06mm	08x50mm	12x15mm
04x10,5mm	06x08mm	08x50mm	12x15mm
04x12mm	06x08mm	09x09mm	12x16mm
04x12mm	06x09mm	09x09mm	12x17mm
04x15mm	06x09mm	09x11mm	12x18mm
04x15mm	06x100mm	09x12mm	12x18mm
04x16mm	06x10mm	09x12mm	12x20mm
04x20mm	06x10mm	09x16mm	12x20mm

MIKROPORÉZNÍ

(výška x šířka)

12x25mm
12x25mm
12x28mm
12x28mm
12x30mm
12x30mm
12x40mm
12x40mm
12x45mm
12x50mm
12x50mm
12,4x12,4mm
13x13mm
13x18mm
13x20mm
13x30mm
14x14mm
14x16mm
14x17mm
14x18mm
15x15mm
15x15mm
15x15mm
15x18mm
15x18mm
15x20mm
15x20mm
15x25mm
15x25mm
15x30mm
15x30mm
15x30mm
15x30mm
15x35mm
15x35mm
15x40mm
15x40mm
15x40mm
15x45mm
15x45mm
15x50mm
15x50mm
16x16mm
16x16mm
16x20mm
16x20mm
16x22mm
16x22mm
16x28mm
16x28mm
16x30mm
16x30mm
17x20mm
17x24mm
17x24mm
17x25mm
17x25mm
18x18mm
18x18mm
18x20mm
18x20mm
18x22mm
18x22mm
18x25mm
18x25mm
20x100mm
20x20mm

SILIKONOVÉ

(výška x šířka)

20x20mm
20x20mm
20x25mm
20x25mm
20x30mm
20x30mm
20x30mm
20x30mm
20x35mm
20x35mm
20x40mm
20x40mm
20x45mm
20x45mm
20x50mm
20x50mm
20x50mm
20x50mm
20x50mm
20x60mm
20x60mm
22x33mm
23x23mm
23x25mm
23x25mm
25x25mm
25x25mm
25x25mm
25x30mm
25x30mm
25x33mm
25x33mm
25x35mm
25x35mm
25x40mm
25x40mm
25x45mm
25x50mm
25x50mm
28x28mm
30x30mm
30x30mm
30x35mm
30x35mm
30x40mm
30x40mm
30x40mm
30x50mm
30x50mm
30x50mm
40x40mm
40x40mm
40x50mm
40x50mm
40x60mm
40x60mm
45x45mm
45x50mm
45x50mm
50x50mm
50x50mm

02x10mm
02x15mm
02x20mm
02x25mm
02x50mm
02x57mm
03x10mm
03x20mm
03x25mm
03x30mm
03x40mm
03x50mm
03x100mm
03,5x03,5mm
04x05,5mm
04x09,5mm
04x23mm
04x25mm
04x40mm
04x40mm
04x40mm
04x60mm
05x07,5mm
05x14mm
05x20mm
05x35mm
05x40mm
05x40mm
05x50mm
05x80mm
06x10mm
06x12mm
06x25mm
06x60mm
06x80mm
07x70mm
07x90mm
08x14mm
08x18mm
08x40mm
08x40mm
08x80mm
10x10mm
10x15mm
10x16mm
10x20mm
10x25mm
10x30mm
10x40mm
12x14mm
12x15mm
12x18mm
13x16mm
14x14mm
14x15mm
14x18mm
14x20mm
15x15mm
15x19mm
15x20mm
15x25mm
15x30mm
16x16mm
16x20mm
20x20mm
20x26mm

20x30mm
25x25mm
25x55mm
25x65mm
27x27mm
30x30mm
50x50mm

SILKONOVÉ MIKROPORÉZNÍ

(výška x šířka)

01,50x20mm	06x06mm	18x18mm
02x10mm	06x70mm	18x23mm
02x10,50mm	06,50x06,50mm	18,50x20mm
02x15mm	07x10mm	20x20mm
02x20mm	07x12mm	20x25mm
02x20mm	07x15mm	20x30mm
02x25mm	07x70mm	20x35mm
02x30mm	08x08mm	20x35mm
02x60mm	08x10mm	20x40mm
03x05mm	08x12mm	20x50mm
03x06mm	08x14mm	20x55mm
03x08mm	08x15mm	20x70mm
03x09mm	08x17mm	22x22mm
03x10mm	08x20mm	23x25mm
03x12mm	08x24mm	24x24mm
03x15mm	08x25mm	25x25mm
03x16mm	08x30mm	25x30mm
03x20mm	08x35mm	25x35mm
03x25mm	08x38mm	25x40mm
03x26,30mm	08x40mm	25x65mm
03x30mm	08x45mm	30x30mm
03x35mm	09x13mm	30x35mm
03x40mm	09x20mm	30x40mm
03x60mm	09,50x14mm	30x45mm
03x8mm	10x10mm	30x50mm
04x05mm	10x12mm	30x60mm
04x10mm	10x13mm	35x35mm
04x12mm	10x15mm	35x40mm
04x15mm	10x16mm	40x40mm
04x20mm	10x18mm	40x40mm
04x22mm	10x20mm	40x40mm
04x30mm	10x22mm	40x100mm
04x40mm	10x25mm	50x50mm
04,50x10mm	10x30mm	60x60mm
04,50x15mm	10x35mm	
04,50x70mm	10x40mm	
04,75x25,40mm	10x45mm	
05x05mm	10x50mm	
05x06mm	10x60mm	
05x08mm	11x16mm	
05x10mm	12x12mm	
05x15mm	12x14mm	
05x20mm	12x15mm	
05x22,50mm	12x16mm	
05x25mm	12x18mm	
05x30mm	12x20mm	
05x35mm	12x25mm	
05x40mm	12x30mm	
05x50mm	12x35mm	
05x59mm	12x40mm	
05x60mm	13x20mm	
05x70mm	15x15mm	
05x80mm	15x17mm	
06x06mm	15x18mm	
06x08mm	15x18,50mm	
06x10mm	15x20mm	
06x10mm	15x22mm	
06x12mm	15x25mm	
06x15mm	15x30mm	
06x16mm	15x35mm	
06x20mm	15x40mm	
06x25mm	15x50mm	
06x30mm	16x16mm	
06x40mm	16x18mm	
06x50mm	16x20mm	
06x60mm	17x20mm	

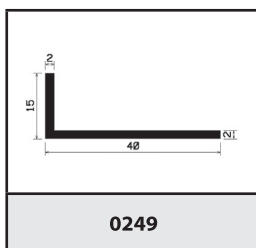

0249

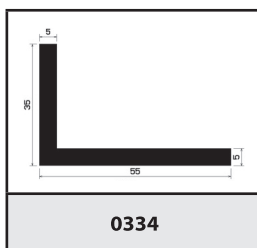

0334

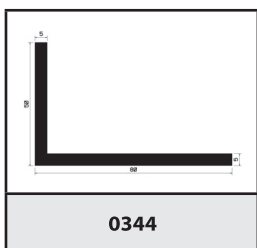

0344

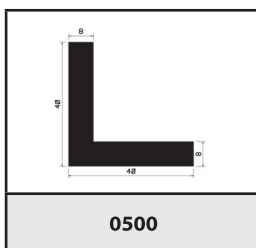

0500

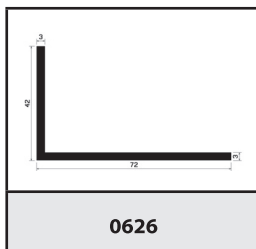

0626

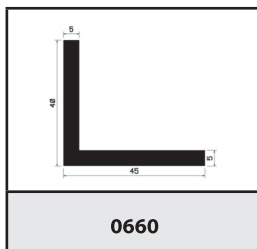

0660

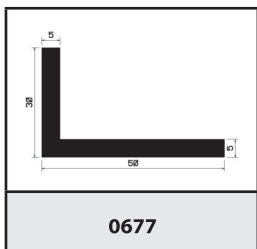

0677

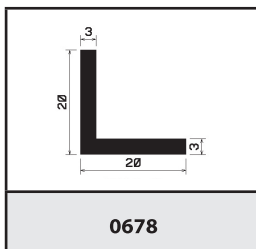

0678

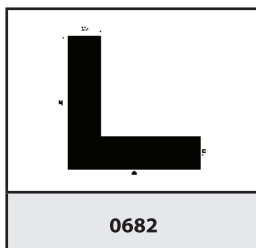

0682

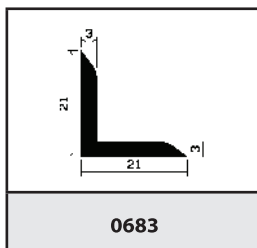

0683

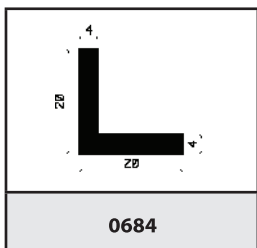

0684

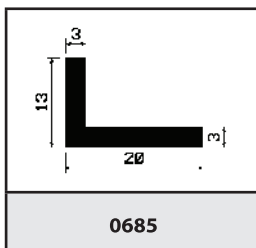

0685

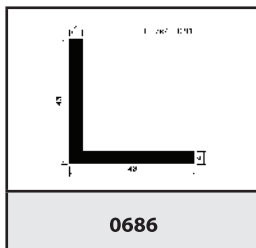

0686

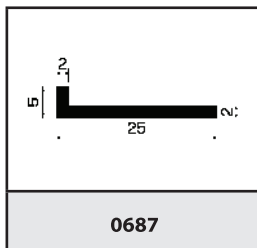

0687

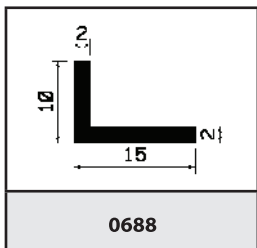

0688

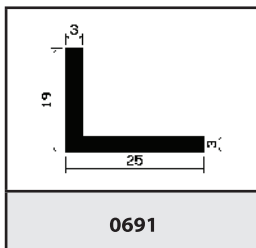

0691

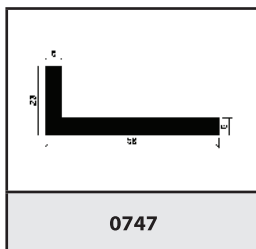

0747

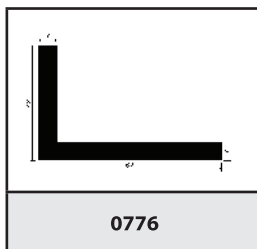

0776

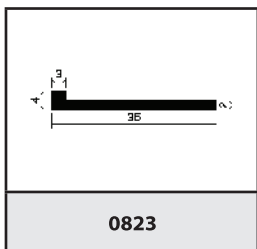

0823

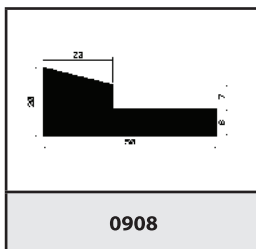

0908

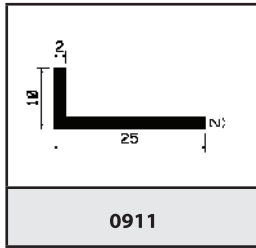

0911

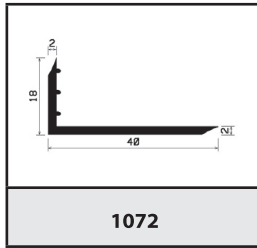

1072

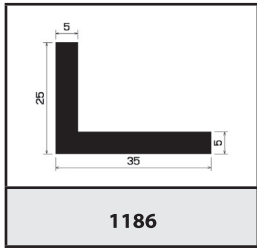

1186

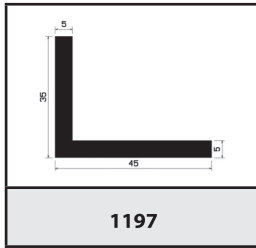

1197

○ mikroperzní, mikroperzní/silikonové ● gumové, silikonové

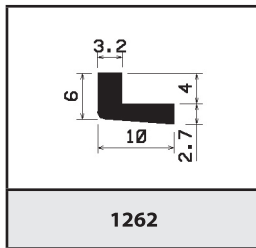

1262

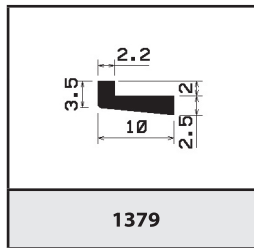

1379

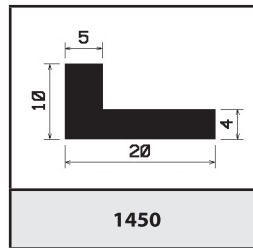

1450

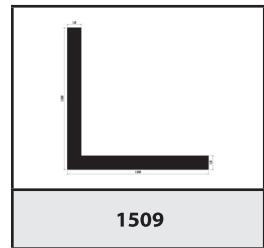

1509

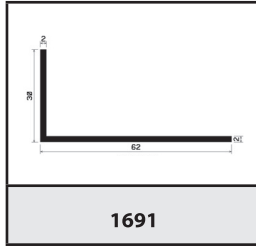

1691

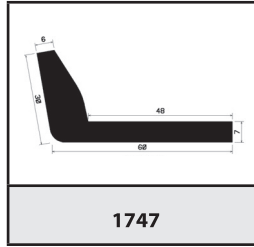

1747

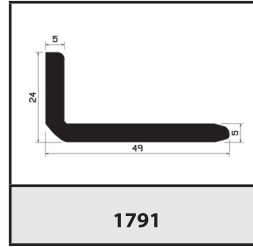

1791

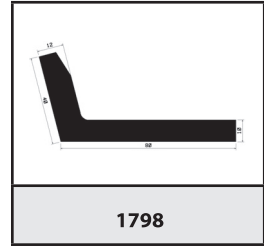

1798

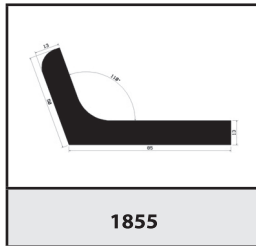

1855

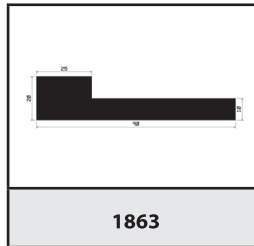

1863

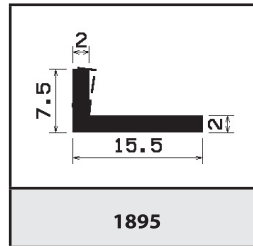

1895

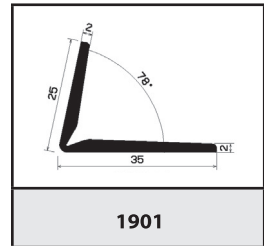

1901

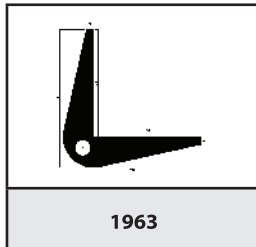

1963

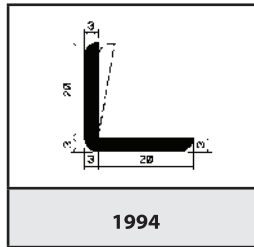

1994

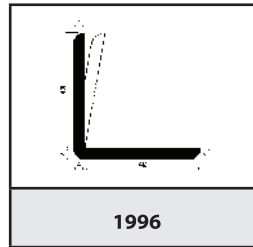

1996

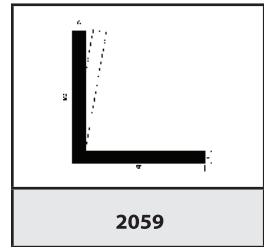

2059

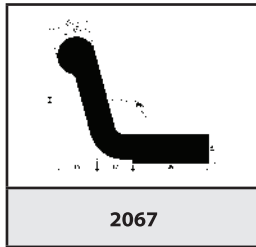

2067

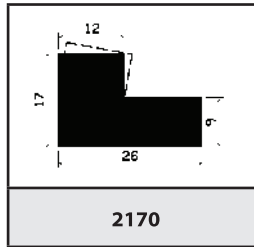

2170

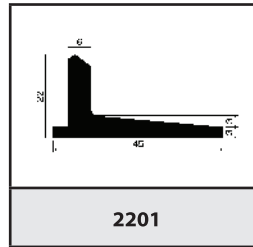

2201

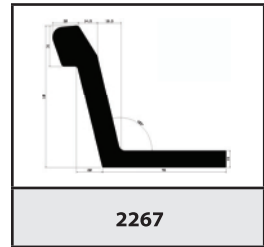

2267

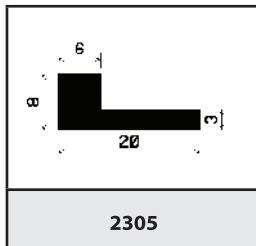

2305

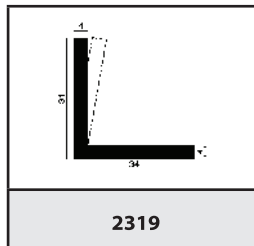

2319

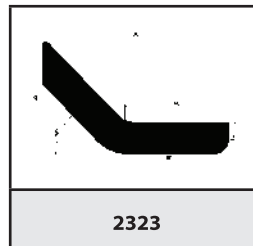

2323

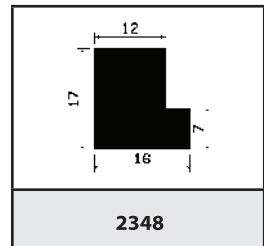

2348

○ mikroporézní, mikroporézní/silikonové ● gumové, silikonové

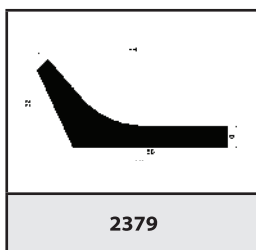

2379

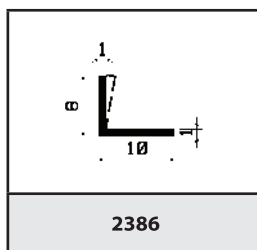

2386

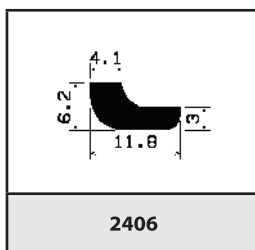

2406

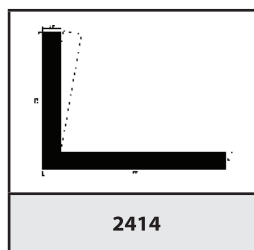

2414

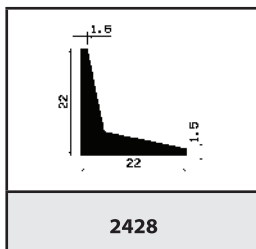

2428

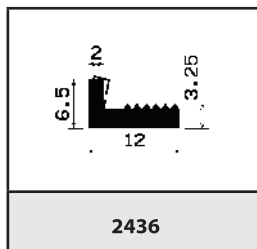

2436

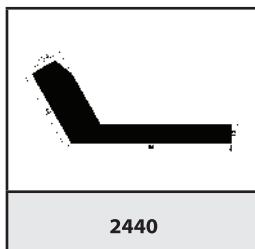

2440

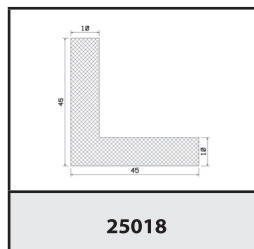

25018

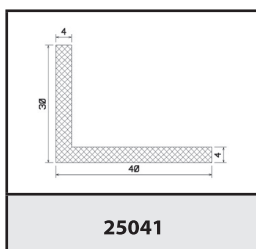

25041

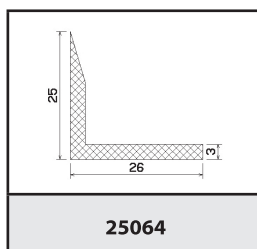

25064

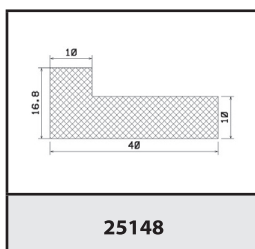

25148

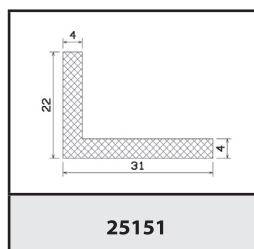

25151

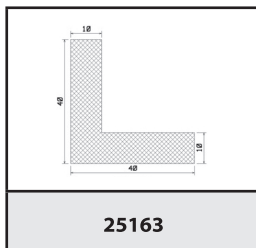

25163

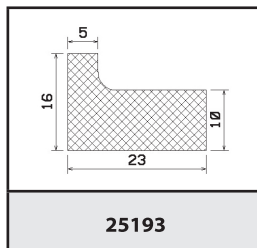

25193

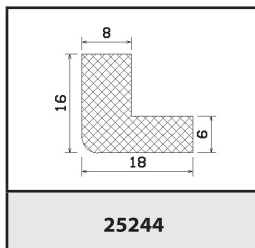

25244

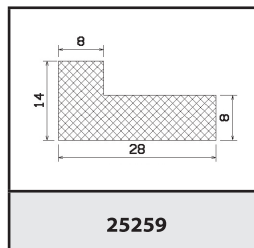

25259

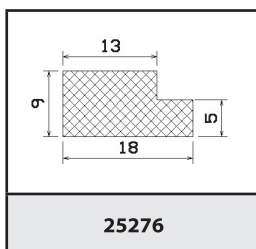

25276

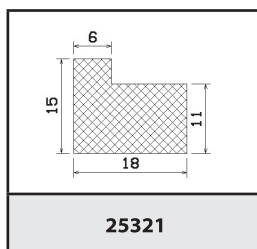

25321

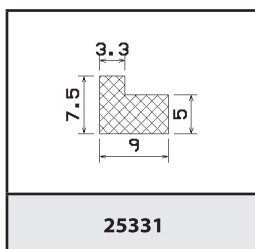

25331

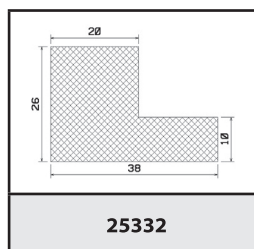

25332

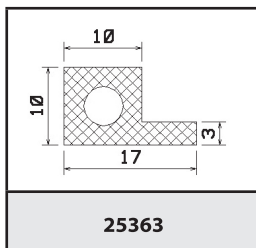

25363

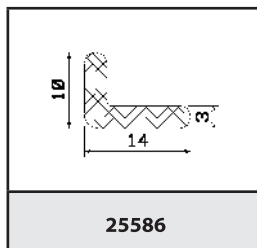

25586

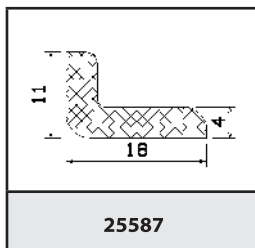

25587

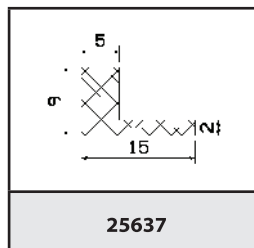

25637

○ mikroporézni, mikroporézni/silikonové ● gumové, silikonové

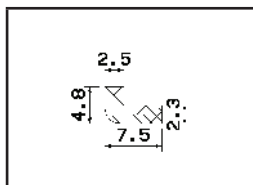

25652

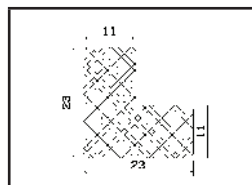

25783

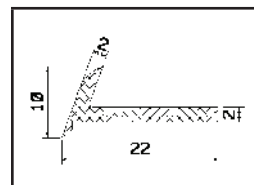

25802

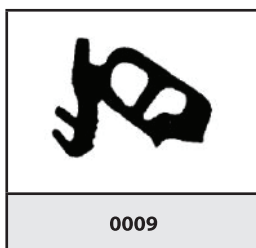

0009

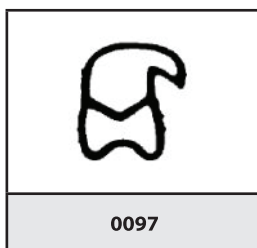

0097

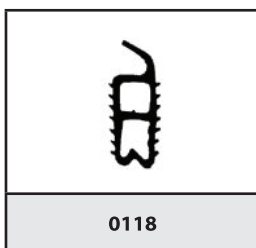

0118

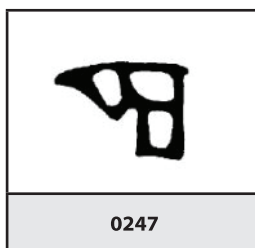

0247

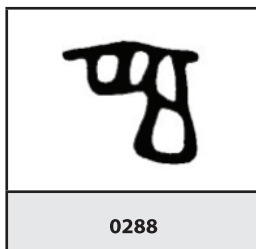

0288

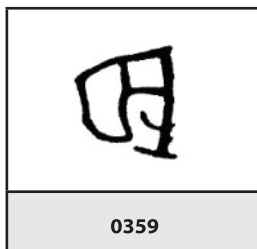

0359



0375

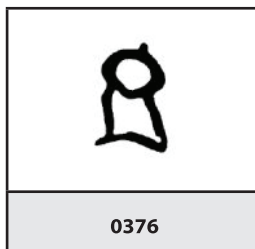

0376

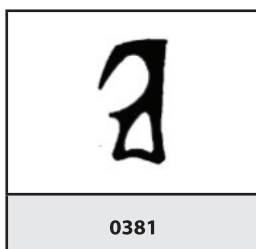

0381



0392

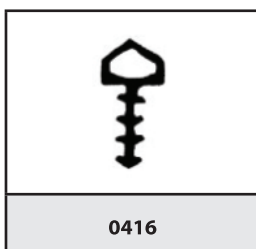

0416



0422

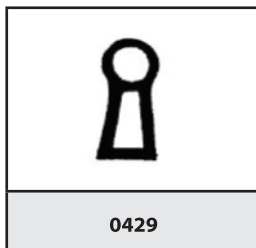

0429

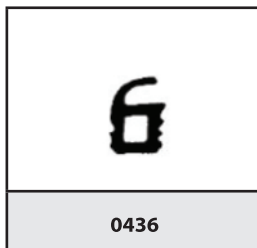

0436

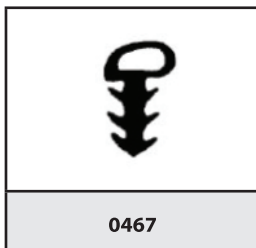

0467

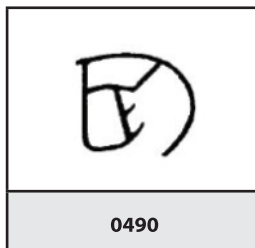

0490

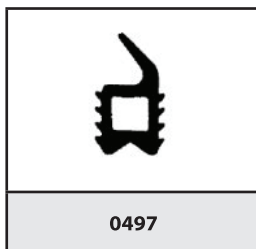

0497

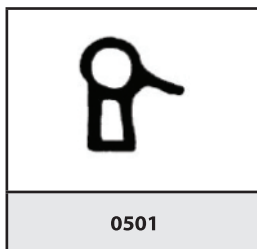

0501



0508



0510

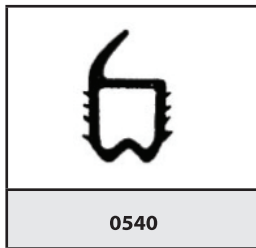

0540

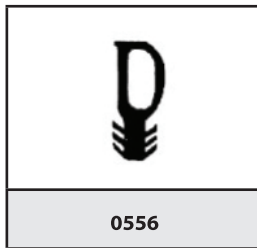

0556

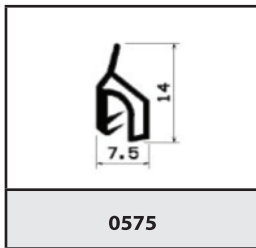

0575

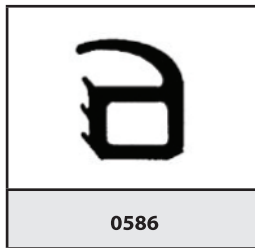

0586

○ mikroporézni, mikroporézni/silikonové ● gumové, silikonové

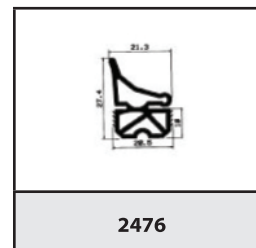
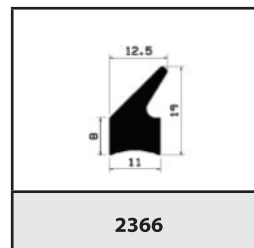
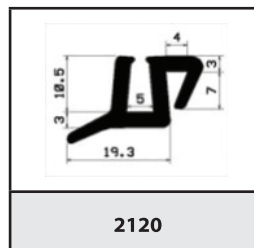
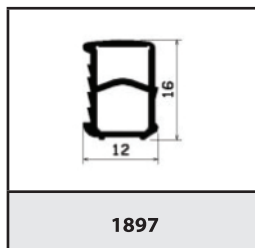
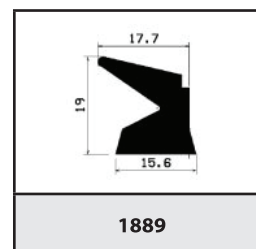
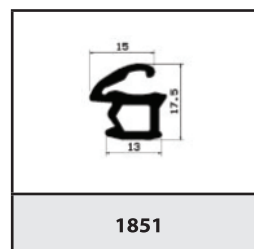
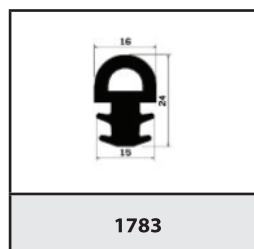
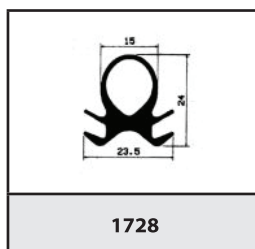
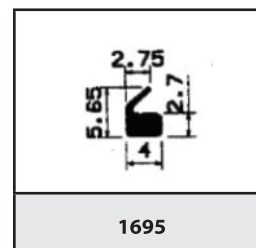
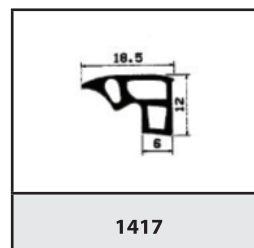
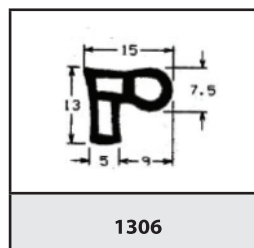
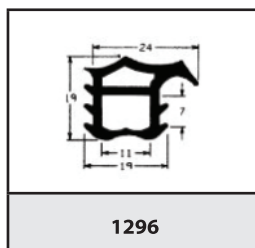
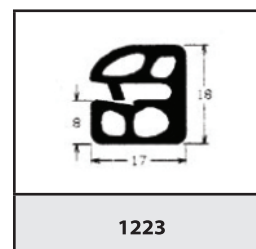
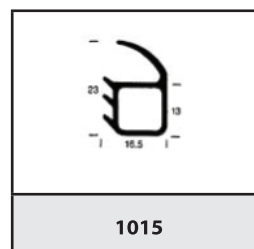
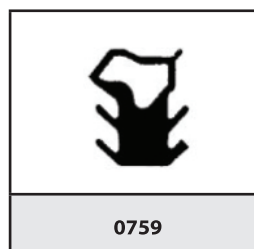
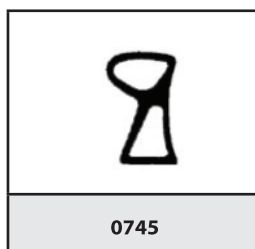
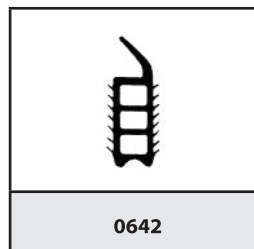
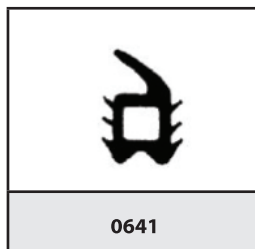
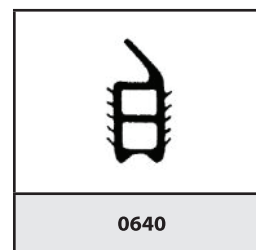
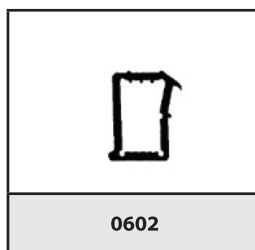

○ mikroporézní, mikroporézní/silikonové ● gumové, silikonové

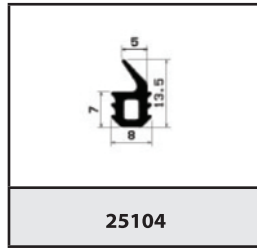
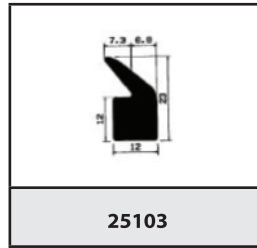
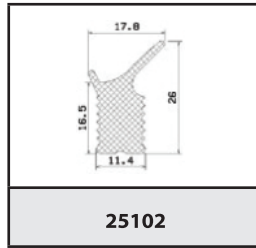
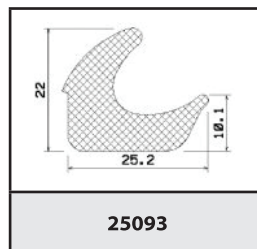
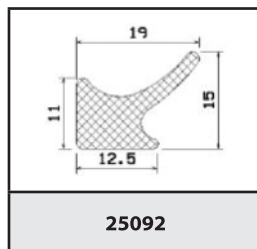
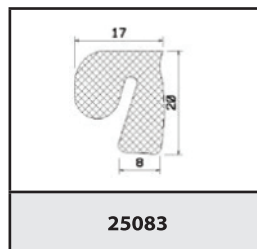
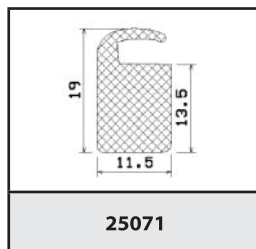
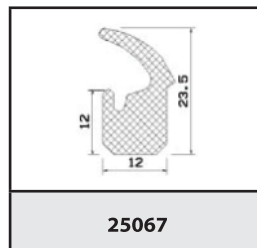
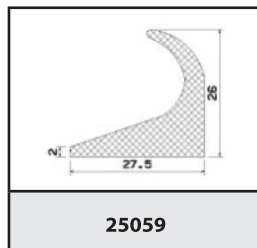
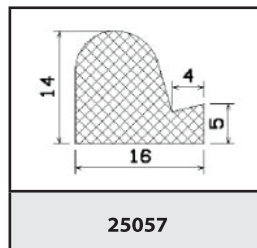
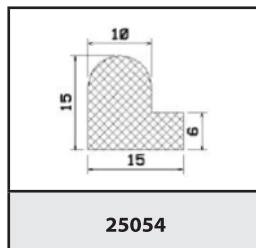
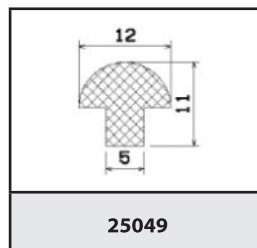
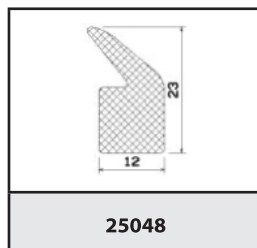
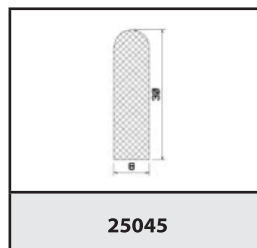
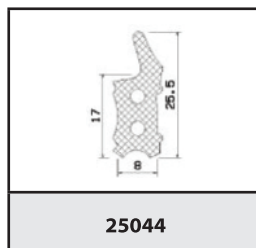
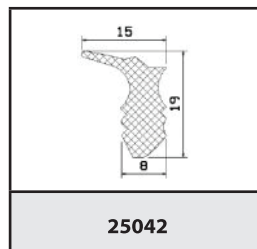
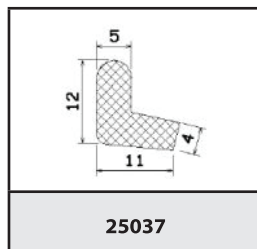
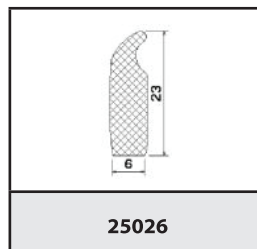
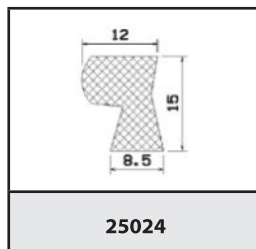
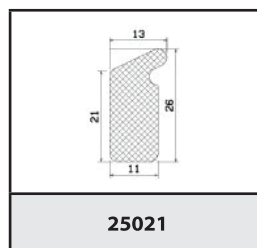
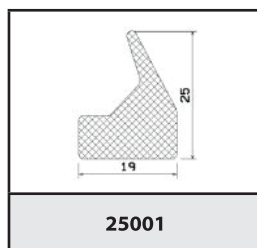
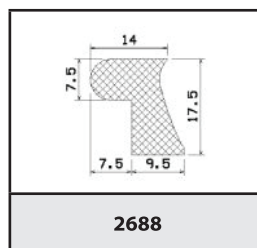
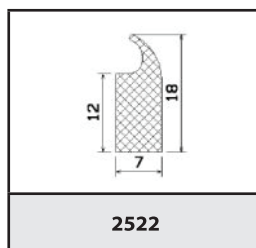

○ mikroporézní, mikroporézní/silikonové ● gumové, silikonové



...těsní hned

Adresa:

Vrbovec 321, 671 24 Vrbovec, Česká republika

Email:

info@aditeg.cz

Telefon / fax:

+420 515 320 023 / +420 515 320 024

IČ / DIČ:

26905710 / CZ26905710

www.aditeg.cz